

# TEM

On | Off and everything in between



2025



# MODUL

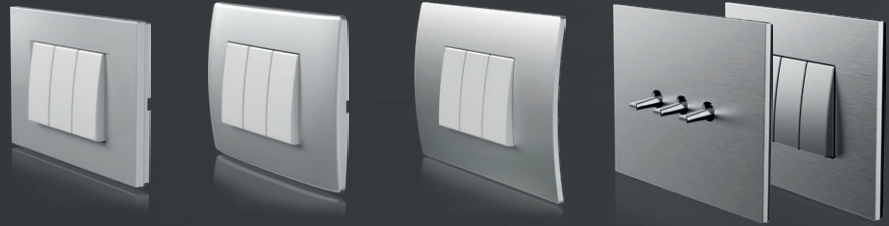

MODUL  
LINE

MODUL  
SOFT

MODUL  
PURE

MODUL  
EDGE

44

# LOGIQ



LOGIQ  
FLAT

LOGIQ  
BOLD

LOGIQ  
PRIME

172

# ekonomik



222

# fontana



260



# TEM

On | Off and everything in between



Smo proizvajalec stikal in vtičnic, ki svojim uporabnikom zagotavlja pozitivno in enostavno izkušnjo, hkrati pa s preprosto vgradnjo in uporabo izdelkov, širokim izborom barv in materialov zadovolji še tako zahtevne želje vsakega uporabnika in prostora.

*We are a manufacturer of switches and sockets offering a positive and easy user experience while satisfying the most demanding needs of every user and space with products that are easy to install and use, as well as a wide range of colours and materials.*

# TEM

## Dobrodošli v družini **MODUL**

Welcome to the **MODUL** family

Ambientu vdahnite osebno noto in vaš slog poudarite s stikali in vtičnicami iz družine MODUL.

*Give your ambience a personal touch and show off your style with switches and sockets from MODUL family.*

## odkrivamo nove poglede

discovering new insights



MODUL  
LINE



MODUL  
SOFT



MODUL  
PURE



MODUL  
EDGE

1

2

MODUL  
LINE



MODUL  
SOFT



MODUL  
PURE

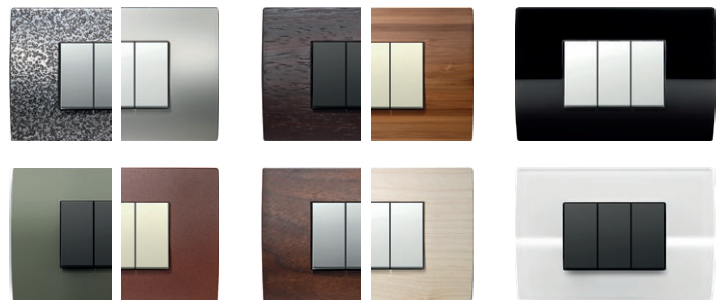

kovina

les

steklo

MODUL  
EDGE

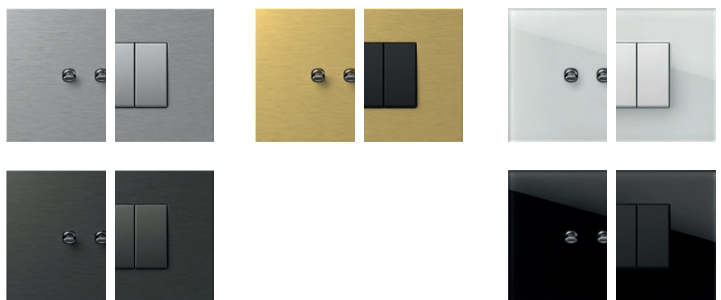

kovina

kovina

steklo



3

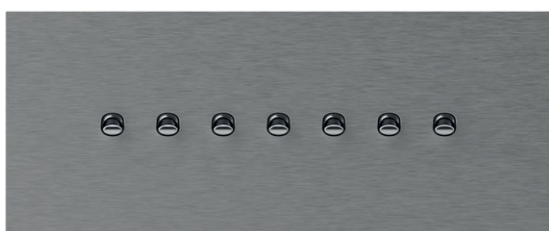

4



MODUL

LINE

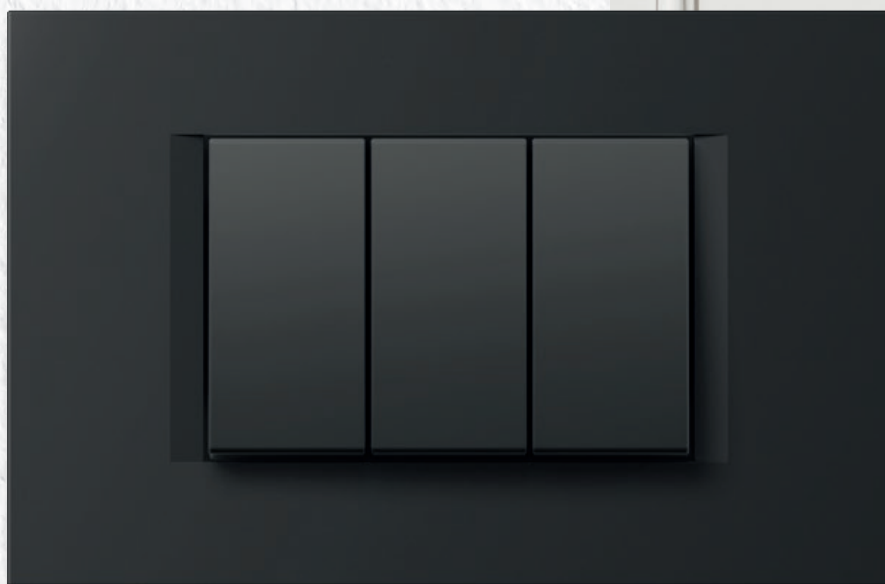

Čiste, ravne linije ustvarjajo brezčasen dizajn.

*Straight, smooth lines create a timeless design.*







MODUL

LINE

PW



bela-sijaj

*polar white*

MW



bela-mat

*matte white*

IW



bež-sijaj

*ivory white*

ES



srebrna-mat

*elox silver*

AT



antracit

*anthracite*

SB



črna-mat

*soft touch  
black*



PW bela-sijaj  
*polar white*

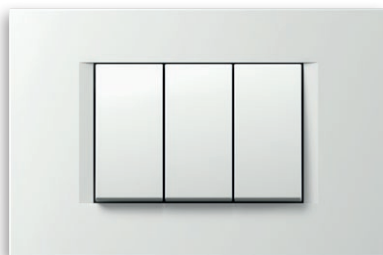

MW bela-mat  
*matte white*

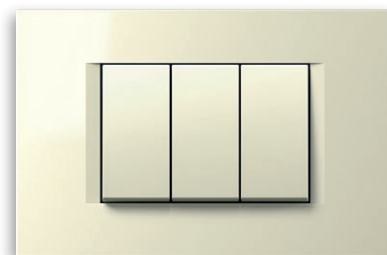

IW bež-sijaj  
*ivory white*



SW kamen beli  
*stone white*

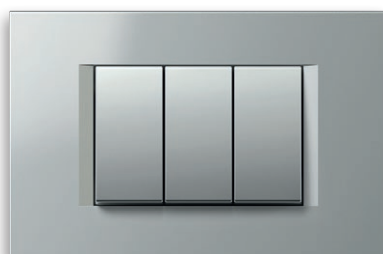

ES srebrna-mat  
*elox silver*

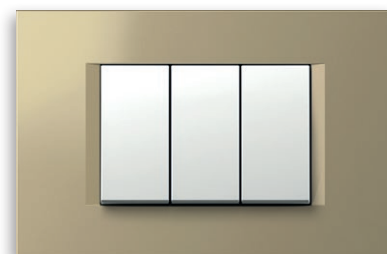

SG zlata-mat  
*sand gold*



TI titan  
*titanium*

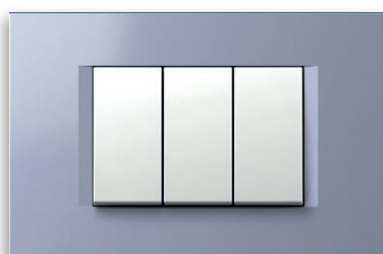

IB modra-mat  
*impulse blue*

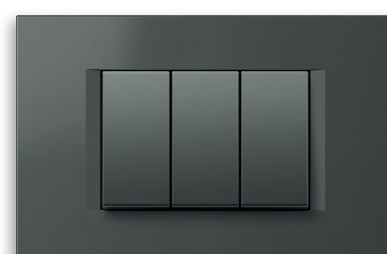

AT antracit  
*anthracite*



NB črna-sijaj  
*night black*



SB črna-mat  
*soft touch black*

MODUL

SOFT



Zaobljene oblike in nežni prehodi prinesejo mehko v vaš dom.

*Rounded shapes and soft transitions bring softness into your home.*





MODUL

SOFT

PW

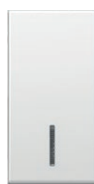

bela-sijaj

*polar white*

MW



bela-mat

*matte white*

IW



bež-sijaj

*ivory white*

ES



srebrna

*elox silver*

AT



antracit

*anthracite*

SB

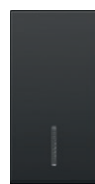

črna-mat

*soft touch  
black*



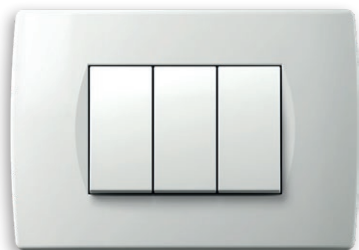

PW bela-sijaj  
*polar white*

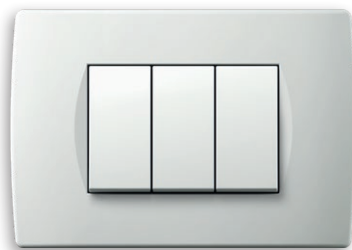

MW bela-mat  
*matte white*

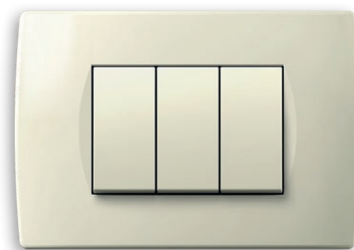

IW bež-sijaj  
*ivory white*



ES srebrna  
*elox silver*

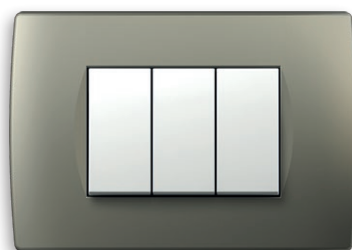

TI titan  
*titanium*

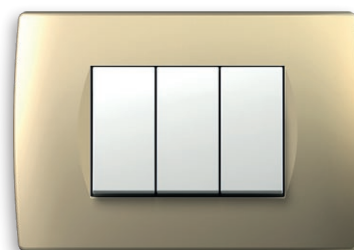

SG zlata  
*sand gold*



WW oreh  
*walnut*



WE wenge  
*wenge*



AT antracit  
*anthracite*



NB črna-sijaj  
*night black*



SB črna-mat  
*soft touch black*

MODUL

PURE



Popolnost ambienta se skriva v podrobnostih. Dovolite naravi, da z dekorativnimi okvirji iz lesa, stekla in kovine obogati vaš prostor.

*The details represent the completeness of the entire ambience. Let the nature enrich your space with decorative cover plates made of wood, glass and metal.*





MODUL

PURE

PW



bela-sijaj

*polar white*

MW



bela-mat

*matte white*

IW



bež-sijaj

*ivory white*

ES



srebrna

*elox silver*

AT



antracit

*anthracite*

SB

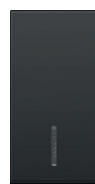

črna-mat

*soft touch  
black*

**steklo**  
*glass*



GL bela  
*glass light*

**kovina**  
*metal*



MH kovano jeklo  
*hammered steel*

**les**  
*wood*



WM javor  
*maple*



GD črna  
*glass dark*

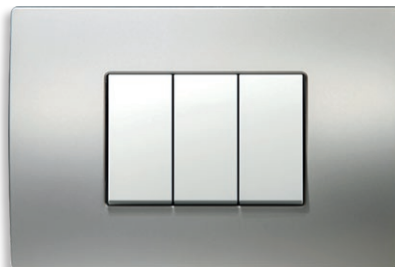

MS satinirano srebro  
*satın silver*



WB bambus  
*bamboo*



MN satiniran nikelj  
*satın nickel*



WW oreh  
*walnut*

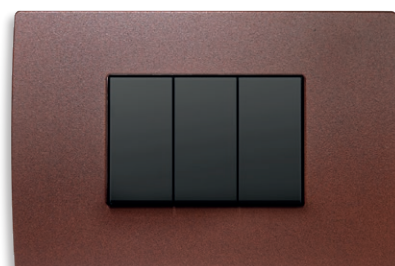

ME zarjavelo železo  
*etched iron*



WE wenge  
*wenge*

MODUL

EDGE

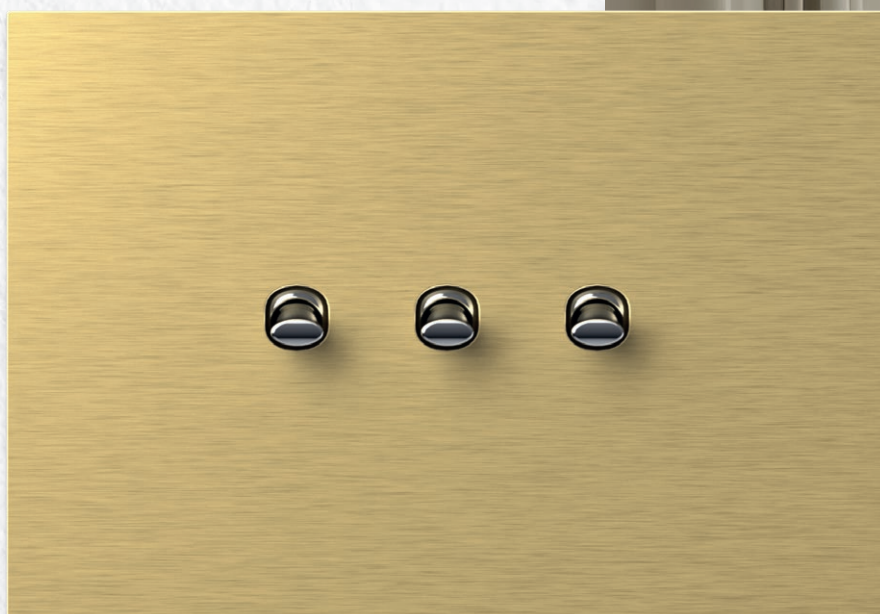

Nova prestižna linija, ki nudi posebno čutno in vizualno izkušnjo kot nikoli doslej. Si upate?

*The new prestigious product line offers a special sensory and visual experience like no other before. Are you bold enough?*







MODUL

EDGE

PB



črna

*black*

PA



antracit

*anthracite*

PG



zlata

*gold*

PC



krom

*chrome*



**kovina**  
*metal*

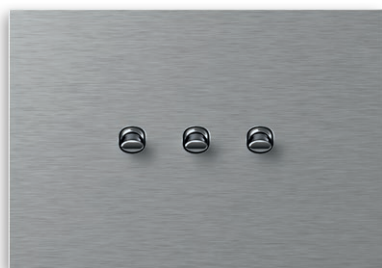

MA srebrna  
*silver*

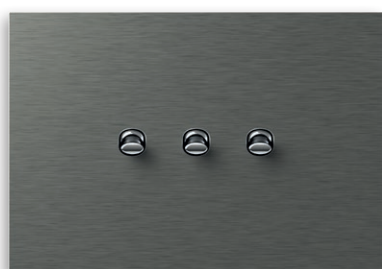
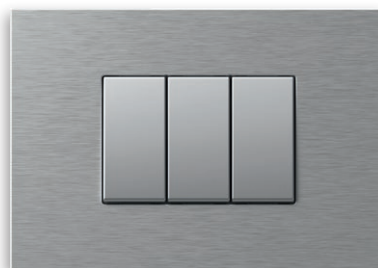

MT antracit  
*anthracite*

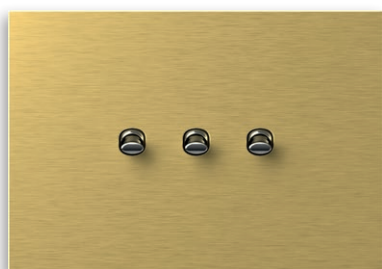

MZ zlata  
*gold*

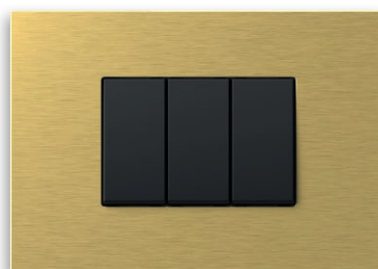

**steklo**  
*glass*

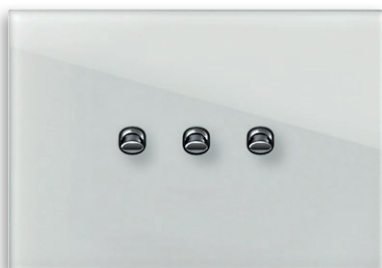

GL bela  
*glass light*

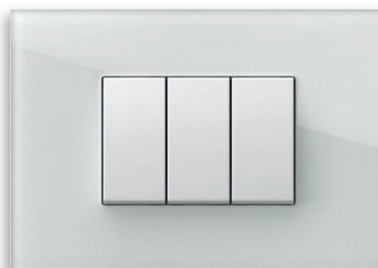

GD črna  
*glass dark*



MODUL  
EDGE



Čistost stekla dovoli svetlobi, da se poigra in manifestira v novih steklenih dekorativnih okvirjih EDGE. Kontrastni barvi zadovoljita še tako prefinjen okus.

*The purity of the glass allows the light to playfully manifest in the new EDGE glass decorative cover plates. The two contrast colours satisfy even the most sophisticated taste.*





**steklo**  
*glass*



GL bela  
*glass light*



GD črna  
*glass dark*

MODUL  
EDGE



Po zaslugi impresivne obdelave aluminij zasije v novi luči - kovinskih dekorativnih okvirjih EDGE. V treh barvnih izkušnjah, vrednih pozornosti.

*Thanks to the impressive treatment, the aluminium shines with a new light – EDGE metal decorative cover plates. The three colours are worthy of your attention.*





**kovina**  
*metal*



MA srebrna  
*silver*

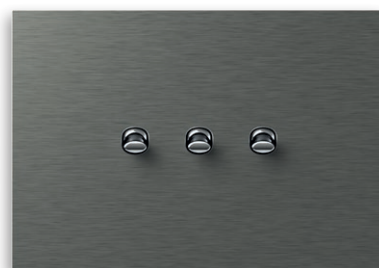

MT antracit  
*anthracite*

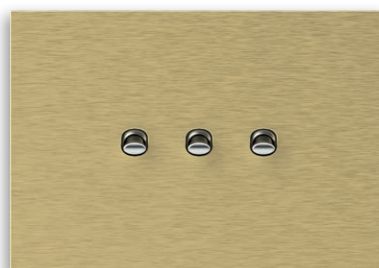

MZ zlata  
*gold*

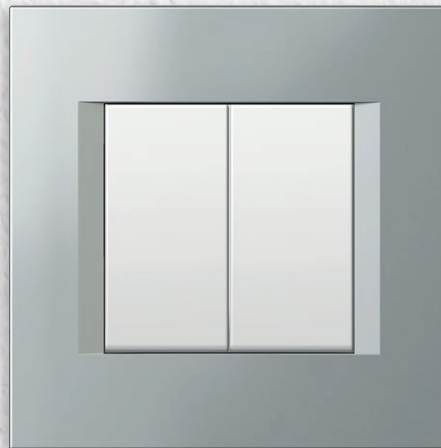

MODUL

-  LINE
-  SOFT
-  PURE
-  EDGE

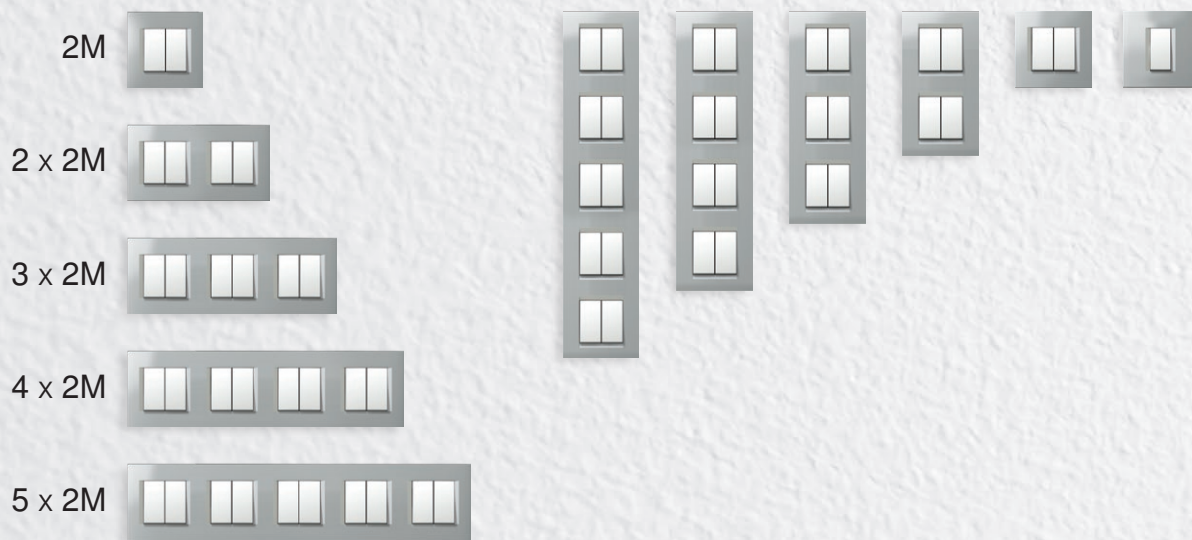
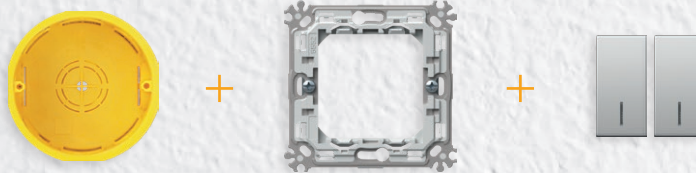

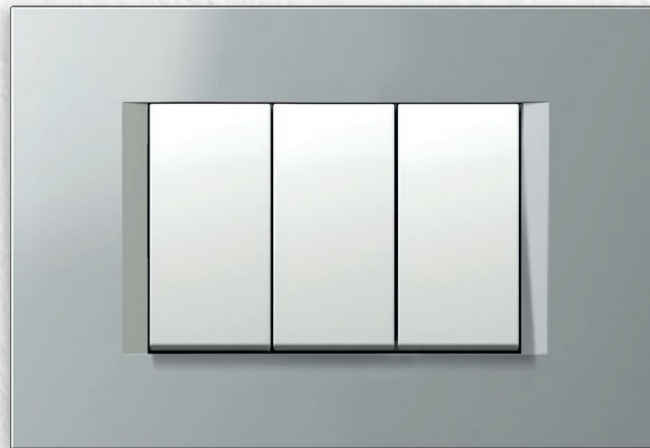

MODUL

- LINE
- SOFT
- PURE
- EDGE



2 x 7M

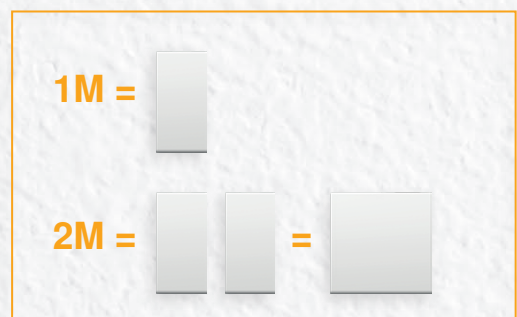

Funkcijske elemente enostavno pritrдите v nosilec. Za vas smo razvili rešitev "klik-in, klik-out", ki vam skrajša čas montaže. Priključni kontakti so lahko dostopni s sprednje strani.

The function elements are easily fitted inside the mounting frame.

The "klik-in, klik-out" solution we have developed for you will reduce installation time. The connection contacts are easily accessible from the front.

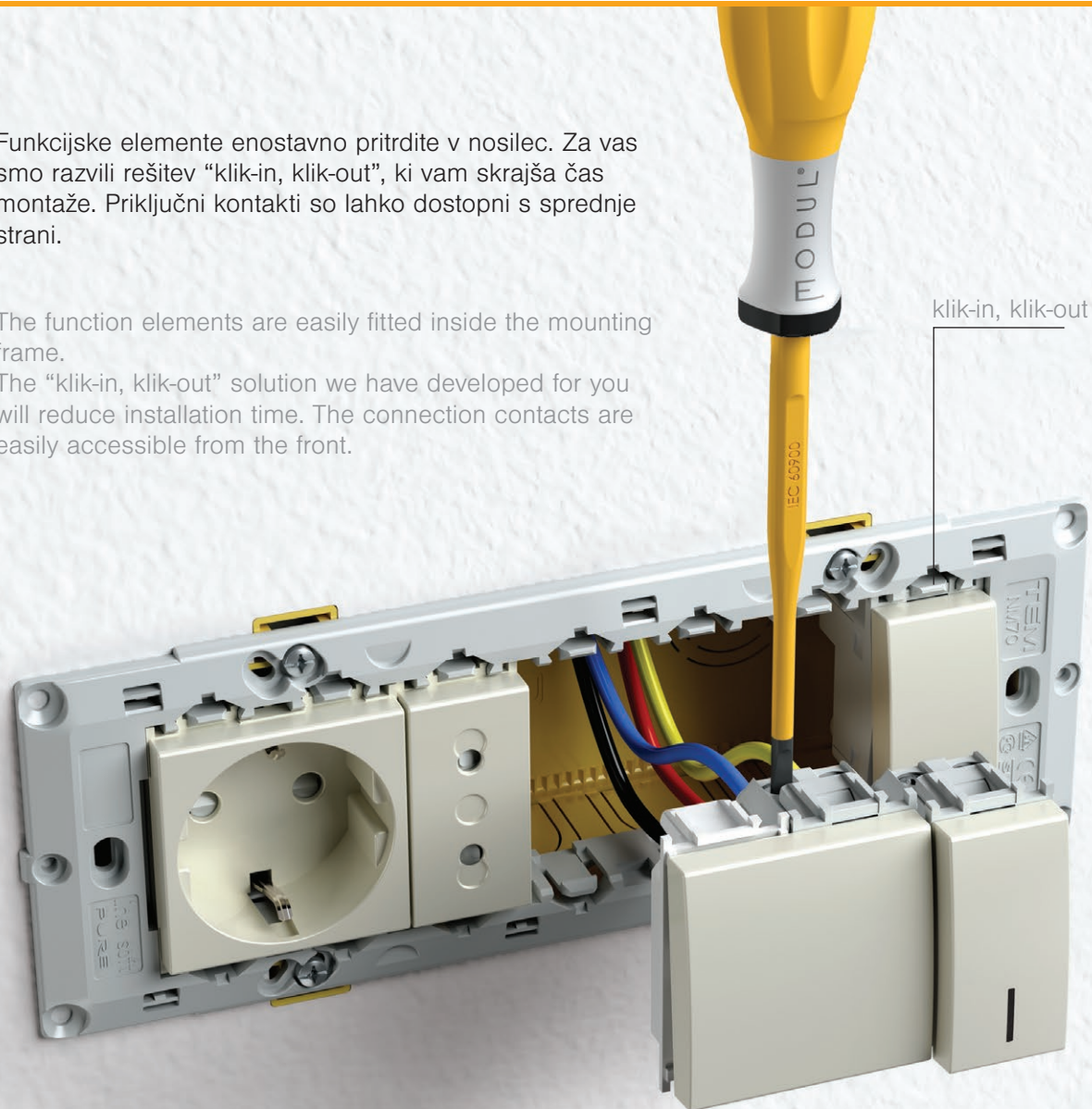



Modul lahko vgradite v katerokoli vrsto stene, naj bo klasična, suho montažna ali betonska. Vgradnja je enostavna, ponuja vam možnosti sestavljanja pravokotnih ali okroglih doz na ustrezne razdalje. Uporabljeni materiali so testirani po visokih standardih.

The Modul is suitable for all wall types and can be used in conventional, hollow wall or concrete constructions. It is easy to install and enables you to combine rectangular or round boxes at the proper distances. The materials used are compliant with high standards.



opeka / brick



votla stena / hollow wall



beton / concrete

Modul vam ponuja veliko možnosti tudi ob uporabi okroglih doz. Kombinirate lahko vodoravno ali navpično, samostojno ali v skupinah. Kovinski nosilec zagotavlja odlično stabilnost tudi pri grobi uporabi in je primeren za vse dekorativne okvirje.

The Modul enables a many possibilities even with round boxes. You can combine them horizontally or vertically, individually or in groups. The metal mounting frame ensures excellent stability even with rough use and is suitable for any decorative cover plates.

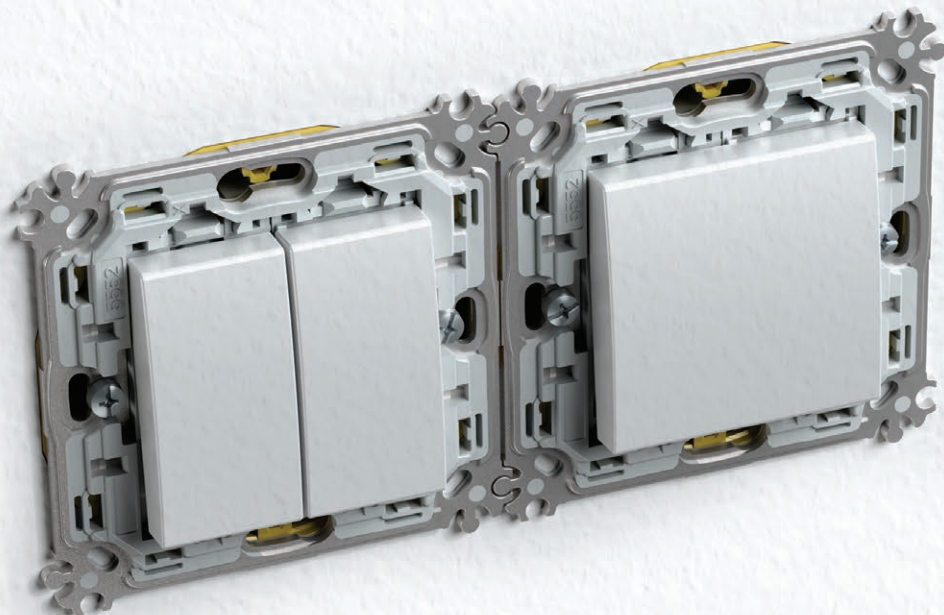



**PW**  
bela-sijaj  
polar white



**MW**  
bela mat  
matte white



**SB**  
črna-mat  
soft touch black



**AT**  
antracit  
anthracite



**ES**  
srebrna  
elox silver



**IW**  
bež-sijaj  
ivory white

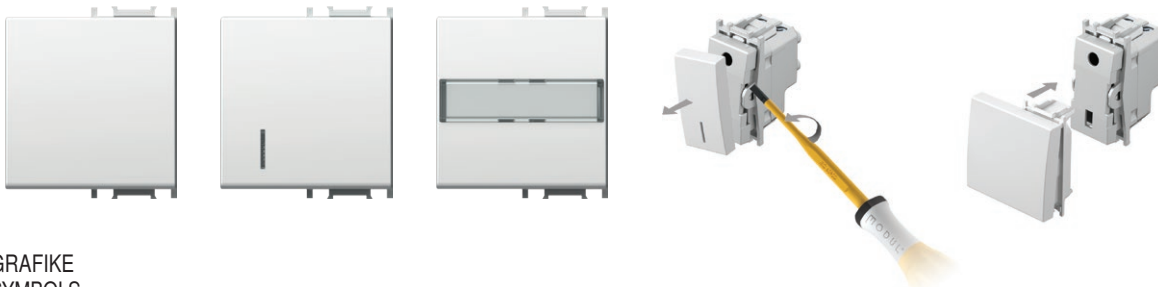

### GRAFIKE SYMBOLS

01	02	03	04	05	06	07	08	09	10	11	12	13	14	20	21
													1 0 2	+	-
22	23	24	25	26	27	28	29	30	31	32	33	34	35	36	37
					alarm	alarm	OFF	ON	+				AC		
38	39	40	41	42	43	44	45	46	47	48					

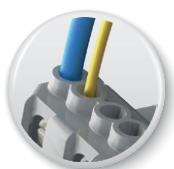
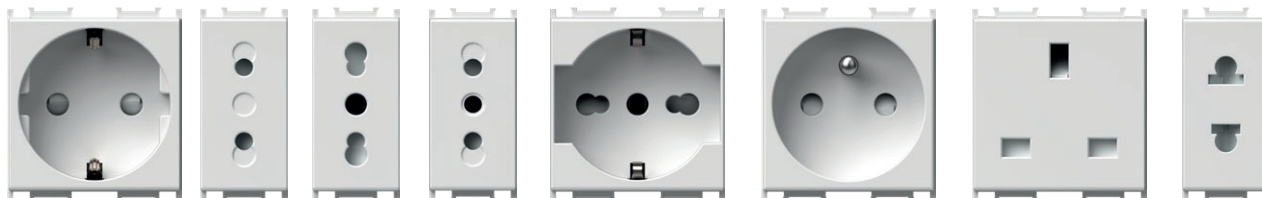

Zanesljiva priključitev vodnikov različnih premerov.

Reliable connection even when different size of wires are used.



Vse vtičnice imajo vgrajeno varovalo pred dotikom elementov pod napetostjo.

All the sockets are equipped with a safety shutters assuring the protection to live contacts.

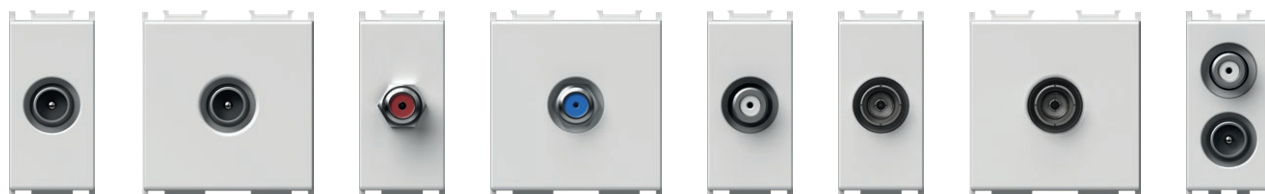
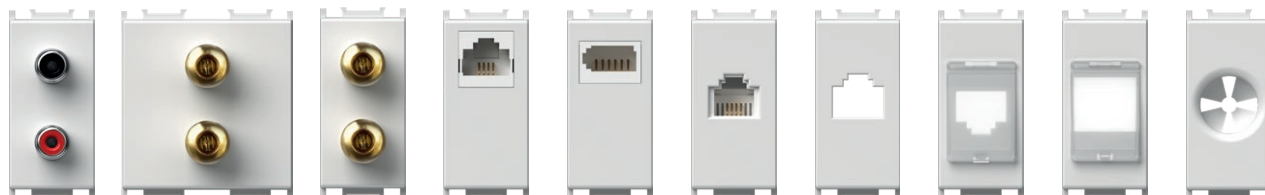

Dolga življenska doba stikal in ustreznost sodobnim standardom.

*Long-life of switches and adequacy to the international standards.*



Zanesljivost preklopa omogočajo srebne kontaktne kovice.

*The switch is highly reliable via its silver rivets contacts.*





## BIOPASS - stikalo na prstni odtis

*BIOPASS - fingerprint switch*

Odklepanje brez ključev.

*Keyless unlocking.*

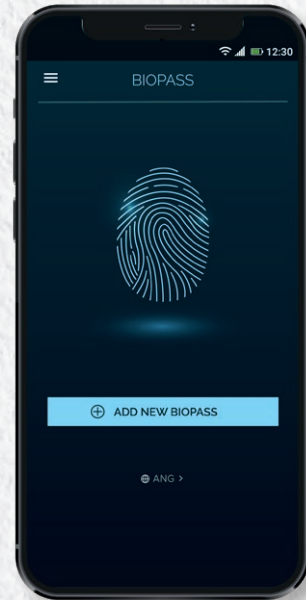

## MULTIMEDIJA

*MULTIMEDIA*

Multimedijski center, ki vam nudi možnost priključitve več različnih komponent na enem mestu.

*Multimedia center that allows you to connect a multiple number of components in one place.*



## OKRASI GA PO SVOJE

### MAKE IT UNIQUE

Izberite barvo osvetlitve in dodajte želene grafike, ki ustrezajo vašemu ambientu.

*Choose a illumination colour and add desired graphic to suit the ambience of your room.*

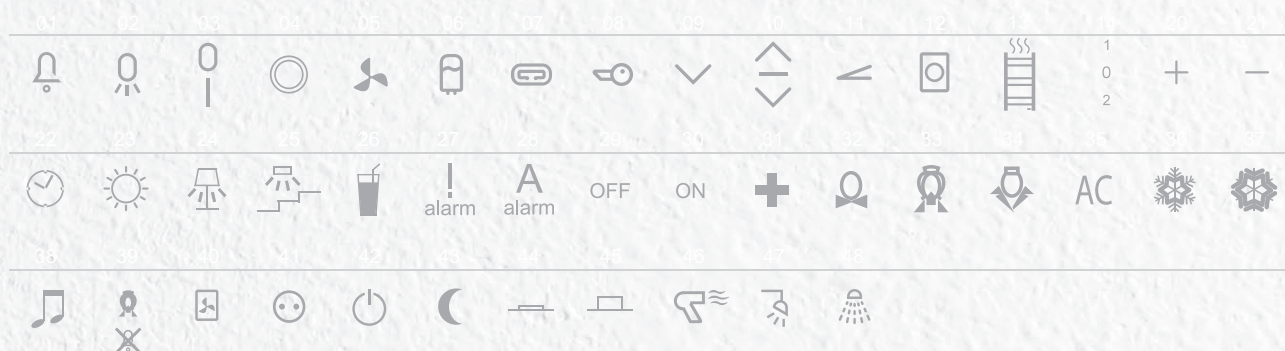

## USTVARI SVOJEGA *CREATE YOUR OWN*

Pri večjem naročilu naredimo okvirje in funkcijske elemente v barvi po vaših željah.

*When ordering large quantities, cover plates and function elements can be made in the colour of your choice.*







## VEČOPRAVILNO ČASOVNO STIKALO

MULTIPURPOSE TIMER SWITCH

4 v 1

- časovnik
- rele
- tipkalo
- stikalo

4 in 1

- timer
- relay
- push button
- switch





15'  
ON/OFF



SM11

PW

IN

01

tip type	naziv description	tehnični opis technical data	velikost size	barva colour	opcijski opis 1 optional data 1	opcijski opis 2 optional data 2
SM10	STIKALO ENOPOLNO SWITCH 1WAY	16AX 250V~	1M	<input type="checkbox"/> PW bela-sijaj polar white	<input type="checkbox"/> NT nevtral neutral	01
SM11	TIPKALO ENOPOLNO PUSH BUTTON 1WAY	16A 250V~	1M	<input type="checkbox"/> MW bela- mat matte white	<input type="checkbox"/> IN indikator indicator	02
SM12	STIKALO ENOPOLNO SWITCH 1WAY	20A 250V~	1M	<input checked="" type="checkbox"/> SB črna- mat soft touch black		03
⋮	⋮	⋮	⋮	<input type="checkbox"/> AT antracit anthracite		
⋮	⋮	⋮	⋮	<input type="checkbox"/> ES srebrna elox silver		
⋮	⋮	⋮	⋮	<input type="checkbox"/> IW bež-sijaj ivory white		

STIKALO ENOPOLNO 16AX 250V~ 1M



SM10



- stikalo brez tipke
  - 16AX 250V~, tip SM10
  - ustreza EN 60669-1
  - vijajčna pritrditev vodnikov 1.5-2.5mm<sup>2</sup>
- SWITCH 1WAY 16AX 250V~ 1M**
- switch without replaceable button
  - 16AX 250V~, type SM10
  - in accordance with EN 60669-1
  - screw contacts 1.5-2.5mm<sup>2</sup>

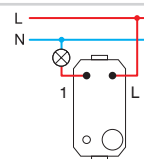

TIPKALO ENOPOLNO 16A 250V~ 1M



SM11



- tipkalo brez tipke
  - 16A 250V~, tip SM11
  - ustreza EN 60669-1
  - vijajčna pritrditev vodnikov 1.5-2.5mm<sup>2</sup>
- PUSH BUTTON 1WAY 16A 250V~ 1M**
- push button without replaceable button
  - 16A 250V~, type SM11
  - in accordance with EN 60669-1
  - screw contacts 1.5-2.5mm<sup>2</sup>

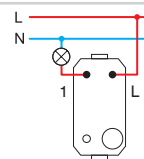

STIKALO ENOPOLNO 20A 250V~ 1M



SM12



- stikalo brez tipke
  - 20A 250V~, tip SM12
  - ustreza EN 60669-1
  - vijajčna pritrditev vodnikov 1.5-2.5mm<sup>2</sup>
- SWITCH 1WAY 20A 250V~ 1M**
- switch without replaceable button
  - 20A 250V~, type SM12
  - in accordance with EN 60669-1
  - screw contacts 1.5-2.5mm<sup>2</sup>

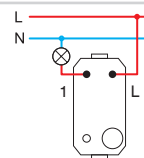

STIKALO DVOPOLNO 16AX 250V~ 1M



SM20

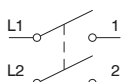

- stikalo brez tipke
  - 16AX 250V~, tip SM20
  - ustreza EN 60669-1
  - vijajčna pritrditev vodnikov 1.5-2.5mm<sup>2</sup>
  - samo v kombinaciji s tipko TM15
- SWITCH 2POLE 16AX 250V~ 1M**
- switch without replaceable button
  - 16AX 250V~, type SM20
  - in accordance with EN 60669-1
  - screw contacts 1.5-2.5mm<sup>2</sup>
  - only in combination with button TM15

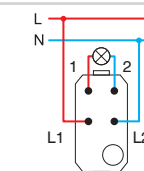

S W I T C H E S S M



SM40



STIKALO ŽALUZIJSKO 1-0-2 16AX 250V~ 1M

- stikalo brez tipke
  - 16AX 250V~, tip SM40
  - ustreza EN 60669-1
  - vijačna pritrditev vodnikov 1.5-2.5mm<sup>2</sup>
- SWITCH SHUTTERS 1-0-2 16AX 250V~ 1M*
- switch without replaceable button
  - 16AX 250V~, type SM40
  - in accordance with EN 60669-1
  - screw contacts 1.5-2.5mm<sup>2</sup>

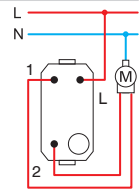

SM41

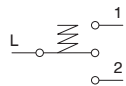

TIPKALO ŽALUZIJSKO 1-0-2 16A 250V~ 1M

- tipkalo brez tipke
  - 16A 250V~, tip SM41
  - ustreza EN 60669-1
  - vijačna pritrditev vodnikov 1.5-2.5mm<sup>2</sup>
- PUSH BUTTON SHUTTERS 1-0-2 16A 250V~ 1M*
- push button without replaceable button
  - 16A 250V~, type SM41
  - in accordance with EN 60669-1
  - screw contacts 1.5-2.5mm<sup>2</sup>

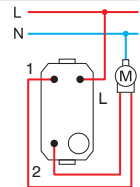

SM60

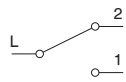

STIKALO MENJALNO 16AX 250V~ 1M

- stikalo brez tipke
  - 16AX 250V~, tip SM60
  - ustreza EN 60669-1
  - vijačna pritrditev vodnikov 1.5-2.5mm<sup>2</sup>
- SWITCH 2WAY 16AX 250V~ 1M*
- switch without replaceable button
  - 16AX 250V~, type SM60
  - in accordance with EN 60669-1
  - screw contacts 1.5-2.5mm<sup>2</sup>

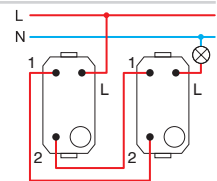

SM61

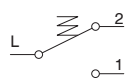

TIPKALO MENJALNO 16A 250V~ 1M

- tipkalo brez tipke
  - 16A 250V~, tip SM61
  - ustreza EN 60669-1
  - vijačna pritrditev vodnikov 1.5-2.5mm<sup>2</sup>
- PUSH BUTTON 2WAY 16A 250V~ 1M*
- push button without replaceable button
  - 16A 250V~, type SM61
  - in accordance with EN 60669-1
  - screw contacts 1.5-2.5mm<sup>2</sup>

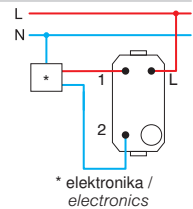

SM70

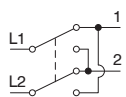

STIKALO KRIŽNO 16AX 250V~ 1M

- stikalo brez tipke
  - 16AX 250V~, tip SM70
  - ustreza EN 60669-1
  - vijačna pritrditev vodnikov 1.5-2.5mm<sup>2</sup>
- SWITCH INTERMEDIATE 16AX 250V~ 1M*
- switch without replaceable button
  - 16AX 250V~, type SM70
  - in accordance with EN 60669-1
  - screw contacts 1.5-2.5mm<sup>2</sup>

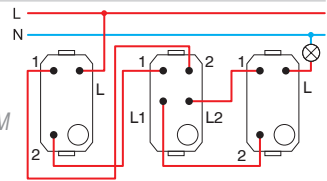

1M = 22,5 x 45  
2M = 45 x 45

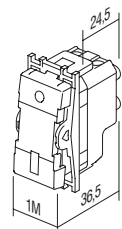
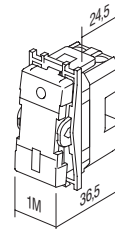



□ PW bela-sijaj  
polar white  
□ MW bela-mat  
matte white



■ SB črna-mat  
soft touch black



■ AT antracit  
anthracite



□ ES srebrna  
elox silver



□ IW bež-sijaj  
ivory white

### STIKALO ENOPOLNO 16AX 250V~ 1M

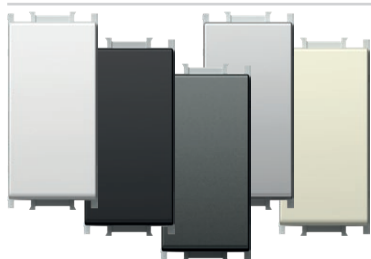

- SM10PW - 16AX 250V~, tip SM10
- SM10MW - ustreza EN 60669-1
- SM10SB - vijačna pritrditev vodnikov 1.5-2.5 mm<sup>2</sup>
- SM10AT - zamenljiva tipka
- SM10ES
- SM10IW

#### SWITCH 1WAY 16AX 250V~ 1M

- 16AX 250V~, type SM10
- in accordance with EN 60669-1
- screw contacts 1.5-2.5 mm<sup>2</sup>
- replaceable button



### STIKALO ENOPOLNO 16AX 250V~ 1M \_\_ IN



- SM10PWIN - IN indikator
- SM10MWIN - 16AX 250V~, tip SM10
- SM10SBIN - ustreza EN 60669-1
- SM10ATIN - vijačna pritrditev vodnikov 1.5-2.5 mm<sup>2</sup>
- SM10ESIN - tlvka ni priložena
- SM10IWIN - zamenljiva tipka

#### SWITCH 1WAY 16AX 250V~ 1M \_\_ IN

- IN indicator
- 16AX 250V~, type SM10
- in accordance with EN 60669-1
- screw contacts 1.5-2.5 mm<sup>2</sup>
- lamp is not included
- replaceable button



### TIPKALO ENOPOLNO 16A 250V~ 1M

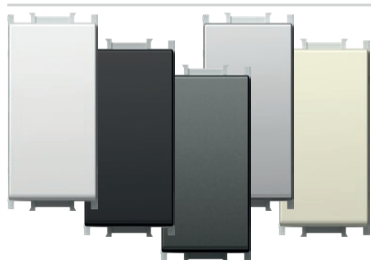

- SM11PW - 16A 250V~, tip SM11
- SM11MW - ustreza EN 60669-1
- SM11SB - vijačna pritrditev vodnikov 1.5-2.5 mm<sup>2</sup>
- SM11AT - zamenljiva tipka
- SM11ES
- SM11IW

#### PUSH BUTTON 1WAY 16A 250V~ 1M

- 16A 250V~, type SM11
- in accordance with EN 60669-1
- screw contacts 1.5-2.5 mm<sup>2</sup>
- replaceable button



### TIPKALO ENOPOLNO 16A 250V~ 1M \_\_ IN 01



- SM11PWIN01 - IN 01 indikator zvonec
- SM11MWIN01 - 16A 250V~, tip SM11
- SM11SBIN01 - ustreza EN 60669-1
- SM11ATIN01 - vijačna pritrditev vodnikov 1.5-2.5 mm<sup>2</sup>
- SM11ESIN01 - tlvka ni priložena
- SM11IWIN01 - zamenljiva tipka

#### PUSH BUTTON 1WAY 16A 250V~ 1M \_\_ IN 01

- IN 01 indicator bell
- 16A 250V~, type SM11
- in accordance with EN 60669-1
- screw contacts 1.5-2.5 mm<sup>2</sup>
- lamp is not included
- replaceable button



## S W I T C H E S S M

## TIPKALO ENOPOLNO 16A 250V~ 1M \_\_ IN 02



- SM11PWIN02 - IN 02 indikator luč
- SM11MWIN02 - 16A 250V~, tip SM11
- SM11SBIN02 - ustreza EN 60669-1
- SM11ATIN02 - vijakna pritržitev vodnikov 1.5-2.5 mm<sup>2</sup>
- SM11ESIN02 - tlička ni priložena
- SM11IWIN02 - zamenljiva tipka

*PUSH BUTTON 1WAY 16A 250V~ 1M \_\_ IN 02*

- IN 02 indicator light
- 16A 250V~, type SM11
- in accordance with EN 60669-1
- screw contacts 1.5-2.5 mm<sup>2</sup>
- lamp is not included
- replaceable button



## STIKALO DVOPOLNO 16AX 250V~ 1M \_\_ NT 03



- SM20PWNT03 - NT 03 nevtral 0-1
- SM20MWNT03 - 16AX 250V~, tip SM20
- SM20SBNT03 - ustreza EN 60669-1
- SM20ATNT03 - vijakna pritržitev vodnikov 1.5-2.5 mm<sup>2</sup>
- SM20ESNT03 - zamenljiva tipka
- SM20IWNT03

*SWITCH 2POLE 16AX 250V~ 1M \_\_ NT 03*

- NT 03 neutral 0-1
- 16AX 250V~, type SM20
- in accordance with EN 60669-1
- screw contacts 1.5-2.5 mm<sup>2</sup>
- replaceable button



## STIKALO DVOPOLNO 16AX 250V~ 1M \_\_ IN



- SM20PWIN - IN indikator
- SM20MWIN - 16AX 250V~, tip SM20
- SM20SBIN - ustreza EN 60669-1
- SM20ATIN - vijakna pritržitev vodnikov 1.5-2.5 mm<sup>2</sup>
- SM20ESIN - tlička ni priložena
- SM20IWIN - zamenljiva tipka

*SWITCH 2POLE 16AX 250V~ 1M \_\_ IN*

- IN indicator
- 16AX 250V~, type SM20
- in accordance with EN 60669-1
- screw contacts 1.5-2.5 mm<sup>2</sup>
- lamp is not included
- replaceable button



## STIKALO ŽALUZIJSKO 1-0-2 16AX 250V~ 1M \_\_ NT 10

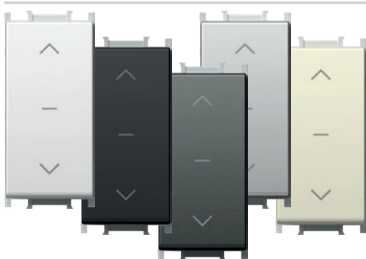

- SM40PWNT10 - NT 10 nevtral 1-0-2
- SM40MWNT10 - 16AX 250V~, tip SM40
- SM40SBNT10 - ustreza EN 60669-1
- SM40ATNT10 - vijakna pritržitev vodnikov 1.5-2.5 mm<sup>2</sup>
- SM40ESNT10 - zamenljiva tipka
- SM40IWNT10

*SWITCH SHUTTERS 1-0-2 16AX 250V~ 1M \_\_ NT 10*

- NT 10 neutral 1-0-2
- 16AX 250V~, type SM40
- in accordance with EN 60669-1
- screw contacts 1.5-2.5 mm<sup>2</sup>
- replaceable button



## TIPKALO ŽALUZIJSKO 1-0-2 16A 250V~ 1M \_\_ NT 10

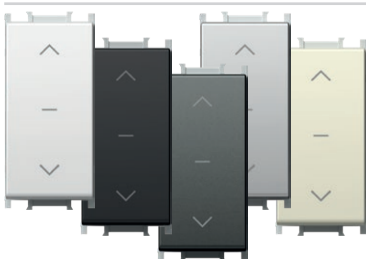

- SM41PWNT10 - NT 10 nevtral 1-0-2
- SM41MWNT10 - 16A 250V~, tip SM41
- SM41SBNT10 - ustreza EN 60669-1
- SM41ATNT10 - vijakna pritržitev vodnikov 1.5-2.5 mm<sup>2</sup>
- SM41ESNT10 - zamenljiva tipka
- SM41IWNT10

*PUSH BUTTON SHUTTERS 1-0-2 16A 250V~ 1M \_\_ NT 10*

- NT 10 neutral 1-0-2
- 16A 250V~, type SM41
- in accordance with EN 60669-1
- screw contacts 1.5-2.5 mm<sup>2</sup>
- replaceable button



## STIKALO MENJALNO 16AX 250V~ 1M

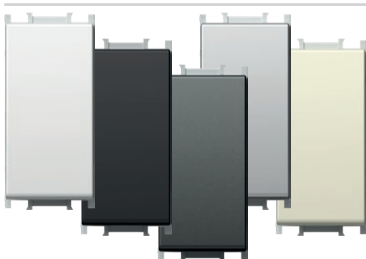

- SM60PW - 16AX 250V~, tip SM60
- SM60MW - ustreza EN 60669-1
- SM60SB - vijakna pritržitev vodnikov 1.5-2.5 mm<sup>2</sup>
- SM60AT - zamenljiva tipka
- SM60ES
- SM60IW

*SWITCH 2WAY 16AX 250V~ 1M*

- 16AX 250V~, type SM60
- in accordance with EN 60669-1
- screw contacts 1.5-2.5 mm<sup>2</sup>
- replaceable button



TIPKALO MENJALNO 16A 250V~ 1M

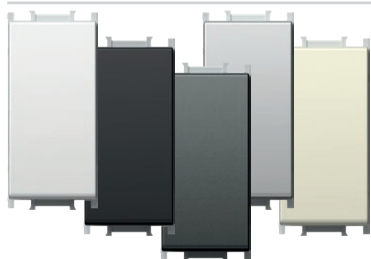

- SM61PW
- SM61MW
- SM61SB
- SM61AT
- SM61ES
- SM61IW

- 16A 250V~, tip SM61  
 - ustreza EN 60669-1  
 - vijačna pritrditev vodnikov 1.5-2.5 mm<sup>2</sup>  
 - zamenljiva tipka

*PUSH BUTTON 2WAY 16A 250V~ 1M*

- 16A 250V~, type SM61  
 - in accordance with EN 60669-1  
 - screw contacts 1.5-2.5 mm<sup>2</sup>  
 - replaceable button



TIPKALO MENJALNO Z VRVICO 16A 250V~ 1M \_\_ CD



- SM62PWCD
- SM62MWCD
- SM62SBCD
- SM62ATCD
- SM62ESCD
- SM62IWCD

- CD indikator+vrvica  
 - vrvica dolžine 1.5m  
 - 16A 250V~, tip SM62  
 - ustreza EN 60669-1  
 - vijačna pritrditev vodnikov 1.5-2.5 mm<sup>2</sup>

*PUSH BUTTON 2WAY WITH CORD 16A 250V~ 1M \_\_ CD*

- CD indikator+cord  
 - cord lenght 1.5m  
 - 16A 250V~, type SM62  
 - in accordance with EN 60669-1  
 - screw contacts 1.5-2.5 mm<sup>2</sup>



STIKALO KRIŽNO 16AX 250V~ 1M

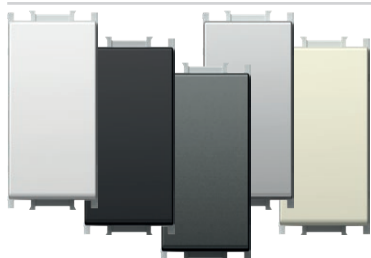

- SM70PW
- SM70MW
- SM70SB
- SM70AT
- SM70ES
- SM70IW

- 16AX 250V~, tip SM70  
 - ustreza EN 60669-1  
 - vijačna pritrditev vodnikov 1.5-2.5 mm<sup>2</sup>  
 - zamenljiva tipka

*SWITCH INTERMEDIATE 16AX 250V~ 1M*

- 16AX 250V~, type SM70  
 - in accordance with EN 60669-1  
 - screw contacts 1.5-2.5 mm<sup>2</sup>  
 - replaceable button



1M = 22,5 x 45  
 2M = 45 x 45

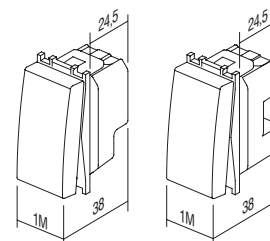



## B U T T O N S T M

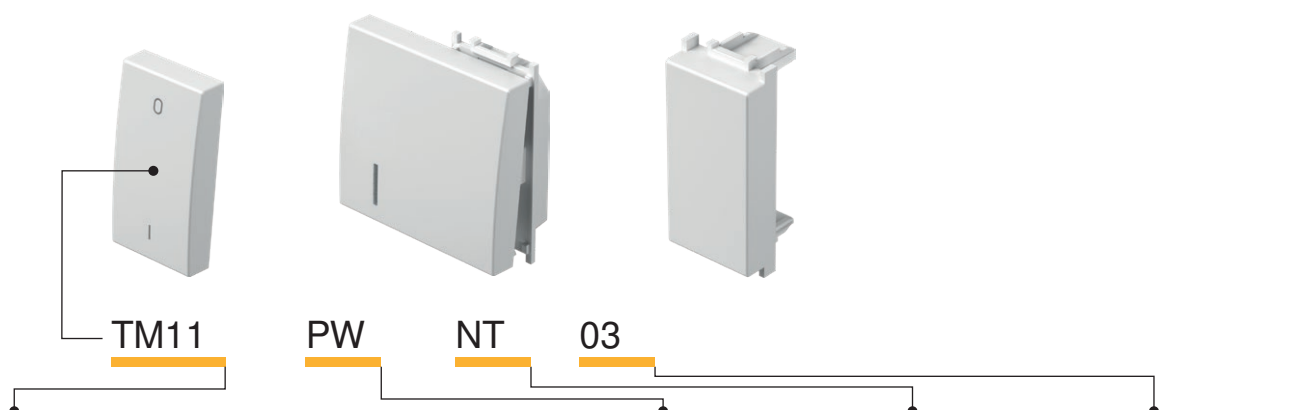

tip type	naziv description	velikost size	barva colour	opcijski opis 1 optional data 1	opcijski opis 2 optional data 2
TM11	TIPKA BUTTON	1M	<input type="checkbox"/> PW bela-sijaj polar white	NT nevtral neutral	01
TM12	TIPKA BUTTON	2M	<input type="checkbox"/> MW bela-mat matte white	IN indikator indicator	02
TM21	POLNILO BLANK	1M	<input checked="" type="checkbox"/> SB črna-mat soft touch black		03
:	:	:	<input checked="" type="checkbox"/> AT antracit anthracite		
:	:	:	<input type="checkbox"/> ES srebrna elox silver		
:	:	:	<input type="checkbox"/> IW bež-sijaj ivory white		

## TIPKA 1M



- TM11PW
- TM11MW
- TM11SB
- TM11AT
- TM11ES
- TM11IW

- zamenljiva tipka velikosti 1M  
- ustreza EN 60669-1

## BUTTON 1M

- replaceable button 1M  
- in accordance with EN 60669-1



## TIPKA 1M INDIKATOR



- TM11PWIN
- TM11MWIN
- TM11SBIN
- TM11ATIN
- TM11ESIN
- TM11IWIN

- zamenljiva tipka velikosti 1M  
- ustreza EN 60669-1

## BUTTON 1M INDICATOR

- replaceable button 1M  
- in accordance with EN 60669-1



## TIPKA 2M

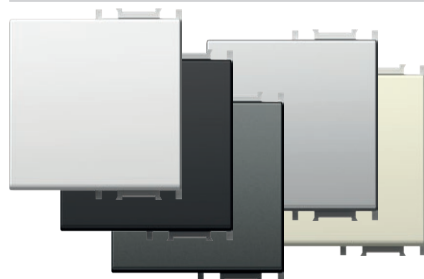

- TM12PW
- TM12MW
- TM12SB
- TM12AT
- TM12ES
- TM12IW

- zamenljiva tipka velikost 2M z nosilcem tipke  
- uporablja se pri nadgradnji stikala ali tipkala velikosti 1M v velikost 2M  
- ustreza EN 60669-1

## BUTTON 2M

- replaceable button 2M with button carrier  
- to upgrade switch or push button from size 1M to size 2M  
- in accordance with EN 60669-1



## TIPKA 2M INDIKATOR

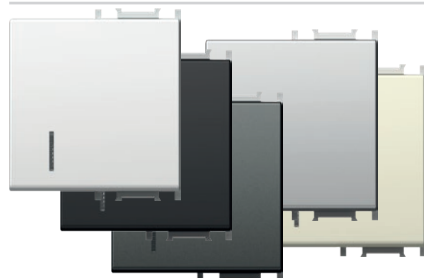

- TM12PWIN
- TM12MWIN
- TM12SBIN
- TM12ATIN
- TM12ESIN
- TM12IWIN

- zamenljiva tipka velikost 2M z nosilcem tipke  
- uporablja se pri nadgradnji stikala ali tipkala velikosti 1M v velikost 2M  
- ustreza EN 60669-1

## BUTTON 2M INDICATOR

- replaceable button 2M with button carrier  
- to upgrade switch or push button from size 1M to size 2M  
- in accordance with EN 60669-1



TIPKA 2M Z NAPISNO PLOŠČICO

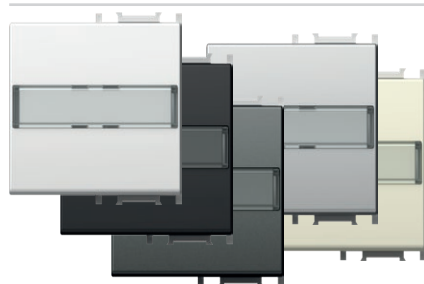

- TM13PWIL
- TM13MWIL
- TM13SBIL
- TM13ATIL
- TM13ESIL
- TM13IWIL

- zamenljiva tipka velikost 2M z nosilcem tipke  
 - uporablja se pri nadgradnji stikala ali tipkala velikosti 1M v velikost 2M  
 - ustreza EN 60669-1

*BUTTON 2M WITH INSCRIPTION PLATE*  
 - replaceable button 2M with button carrier  
 - to upgrade switch or push button from size 1M to size 2M  
 - in accordance with EN 60669-1



TIPKA 1M DVOPOLNA

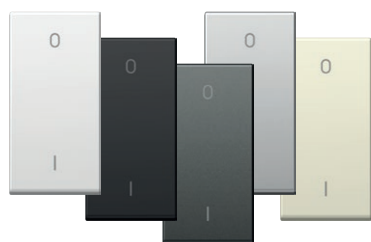

- TM15PW
- TM15MW
- TM15SB
- TM15AT
- TM15ES
- TM15IW

- zamenljiva tipka velikosti 1M  
 - samo v kombinaciji z mehanizmom SM20  
 - ustreza EN 60669-1

*BUTTON 1M 2POLE*  
 - replaceable button 1M  
 - only in combination with mechanism SM20  
 - in accordance with EN 60669-1



POLNILO 1M

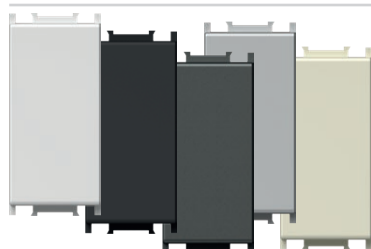

- TM21PW
- TM21MW
- TM21SB
- TM21AT
- TM21ES
- TM21IW

- za zapolnjevanje praznih mest  
 - ustreza EN 60669-1

*BLANK 1M*  
 - blank modul to fill up empty spaces  
 - in accordance with EN 60669-1



POLNILO 2M

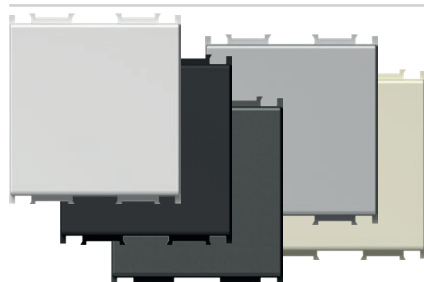

- TM22PW
- TM22MW
- TM22SB
- TM22AT
- TM22ES
- TM22IW

- za zapolnjevanje praznih mest  
 - ustreza EN 60669-1

*BLANK 2M*  
 - blank modul to fill up empty spaces  
 - in accordance with EN 60669-1

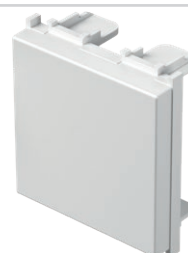

UVODNICA 1M

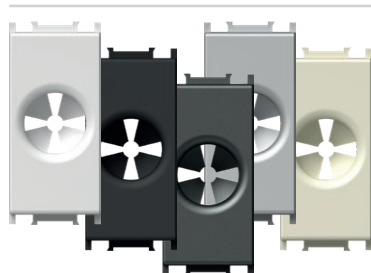

- TM31PW
- TM31MW
- TM31SB
- TM31AT
- TM31ES
- TM31IW

- uvodnica za kabel  
 - ustreza EN-60669-1

*CABLE OUTLET 1M*  
 - outlet for cable  
 - in accordance with EN-60669-1



1M = 22,5 x 45  
 2M = 45 x 45



TM11  
 TM15

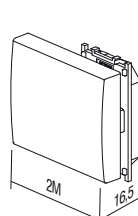

TM12  
 TM13

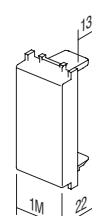

TM21

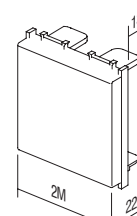

TM22

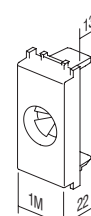

TM31

## B U T T O N S T M

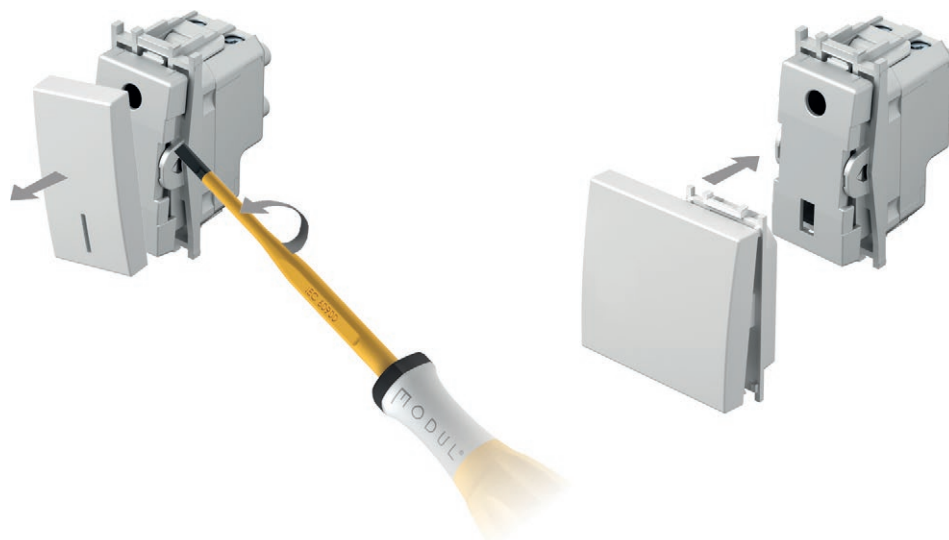

## LASERSKI TISK NA TIPKE

- laserski tisk poljubne grafike na označena mesta
- standardni simboli iz zaloge, ostali po naročilu

## LASER PRINT ON BUTTONS

- laser print of any graphics on marked locations
- standard symbols from stock, other on request

1M

A
B
C

2M

A	D	G
B	E	H
C	F	I

## GRAFIKE

## SYMBOLS

01	02	03	04	05	06	07	08	09	10	11	12	13	14	20	21
													1 0 2	+	-
22	23	24	25	26	27	28	29	30	31	32	33	34	35	36	37
					alarm	alarm	OFF	ON	+				AC		
38	39	40	41	42	43	44	45	46	47	48					

## STANDARDNE GRAFIKE

## STANDARD SYMBOLS

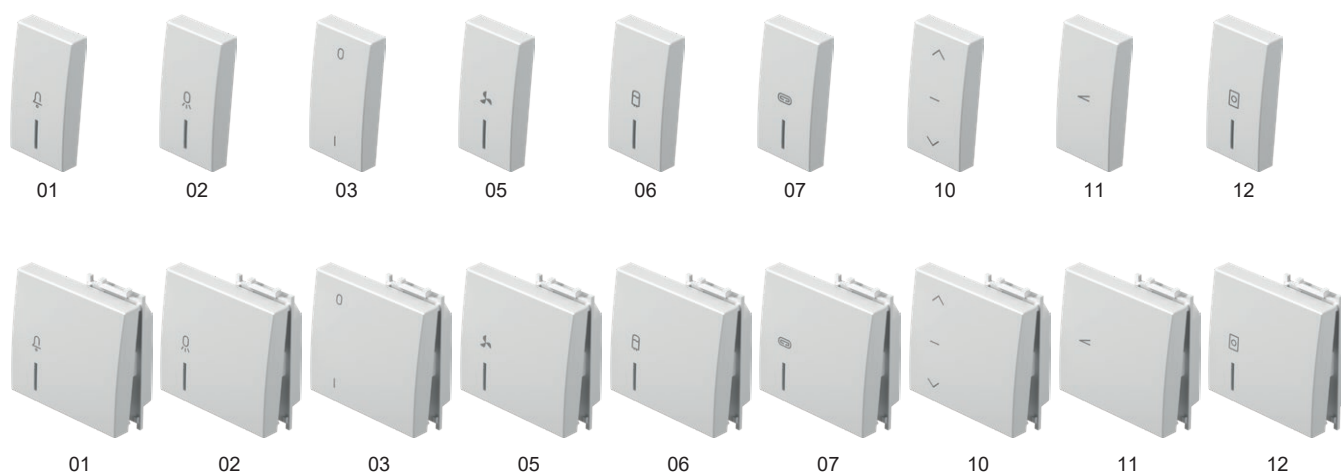

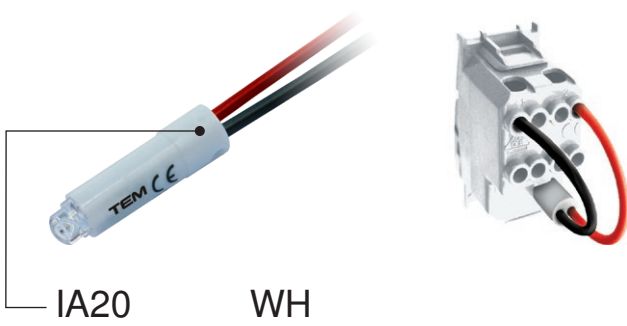

tip type	naziv description	tehnični opis technical data	barva colour
IA10	TLIVKA NEON LAMP	230V~ 0,34W	<input type="checkbox"/> WH bela white
IA20	LED SIGNALIZACIJA LED SIGNALLING UNIT	230V~ AC/DC 0,40W	<input checked="" type="checkbox"/> BL modra blue
IA21	LED SIGNALIZACIJA LED SIGNALLING UNIT	24V AC/DC 0,20W	<input checked="" type="checkbox"/> RD rdeča red
·	·	·	<input checked="" type="checkbox"/> GR zelena green
·	·	·	<input checked="" type="checkbox"/> OR oranžna orange

TLIVKA 230V~ 0,34W

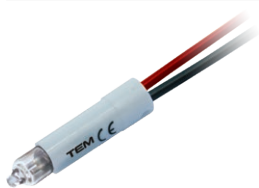

IA10OR

- za indikacijo, signalizacijo ali stalno signalizacijo
- v kombinaciji s tipko z indikatorjem

NEON LAMP 230V~ 0,34W

- for indication, signalling or permanent signalling
- in combination with a button featuring an indicator

LED SIGNALIZACIJA 230V AC/DC 0,40W



- IA20WH
- IA20GR
- IA20RD
- IA20BL

- za indikacijo, signalizacijo ali stalno signalizacijo
- v kombinaciji s tipko z indikatorjem

LED SIGNALLING UNIT 230V AC/DC 0,40W

- for indication, signalling or permanent signalling
- in combination with a button featuring an indicator

LED SIGNALIZACIJA 24V AC/DC 0,20W



- IA21WH
- IA21RD

- za indikacijo, signalizacijo ali stalno signalizacijo
- v kombinaciji s tipko z indikatorjem

LED SIGNALLING UNIT LAMP 24V AC/DC 0,20W

- for indication, signalling or permanent signalling
- in combination with a button featuring an indicator

LED SIGNALIZACIJA 12V AC/DC 0,10W



- IA22WH
- IA22RD

- za indikacijo, signalizacijo ali stalno signalizacijo
- v kombinaciji s tipko z indikatorjem

LED SIGNALLING UNIT 12V AC/DC 0,10W

- for indication, signalling or permanent signalling
- in combination with a button featuring an indicator

RC VEZJE 250V~

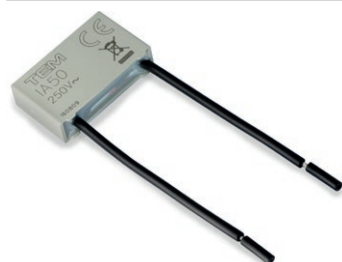

IA50

- RC vezje za odpravo motenj pri delovanju LED sijalk
- možna je vzporedna vezava več RC vezij s sijalkami
- 0,1 µF, 100 Ω, 250V~

RC CIRCUIT 250V~

- RC circuit to eliminate disturbances in the operation of LED lamps
- parallel connections of more RC circuits with lamps are possible
- 0,1 µF, 100 Ω, 250V~

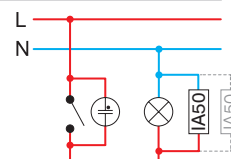

## S I G N A L I Z A T I O N I A

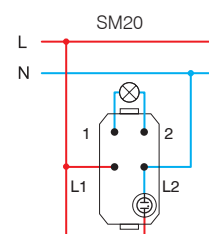
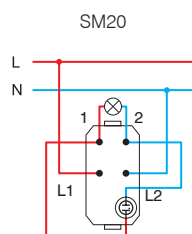
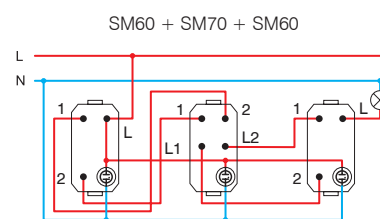
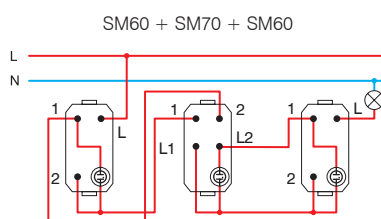
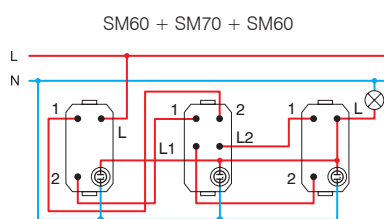
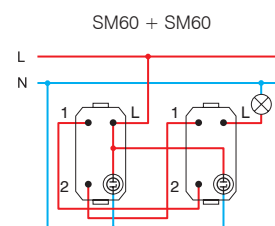
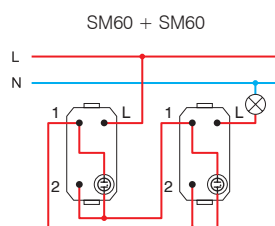
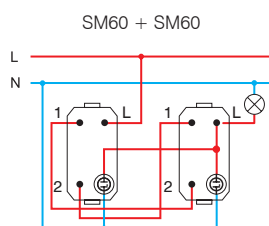
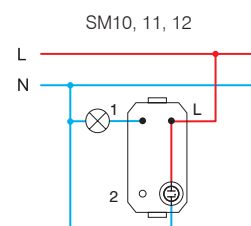
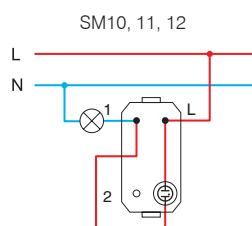
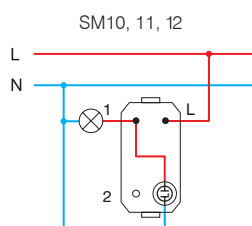
Indikacija /  
Indication\* Signalizacija /  
SignalizationStalna signalizacija  
Permanent signalling

\* vezave niso primerne za varčne (CFL, LED) sijalke /  
the connections are not suitable for energy-saving bulbs (CFL, LED)

1M = 22,5 x 45  
2M = 45 x 45

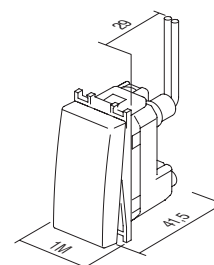

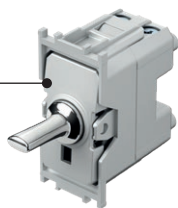

SP10

PC

tip type	naziv description	tehnični opis technical data	velikost size	barva pinov pin colour
SP10	STIKALO ENOPOLNO SWITCH 1WAY	16AX 250V~	1M	■ PC krom chrome
SP11	TIPKALO ENOPOLNO PUSH BUTTON 1WAY	16A 250V~	1M	■ PA antracit anthracite
SP12	STIKALO ENOPOLNO SWITCH 1WAY	20A 250V~	1M	■ PB črna black
⋮	⋮	⋮	⋮	■ PG zlata gold

STIKALO ENOPOLNO 16AX 250V~ 1M



- SP10PC
- SP10PA
- SP10PB
- SP10PG

- stikalo  
- 16AX 250V~, tip SP10  
- ustreza EN 60669-1  
- vijajčna pritrditev vodnikov 1.5-2.5mm<sup>2</sup>  
**SWITCH 1WAY 16AX 250V~ 1M**  
- switch  
- 16AX 250V~, type SP10  
- in accordance with EN 60669-1  
- screw contacts 1.5-2.5mm<sup>2</sup>

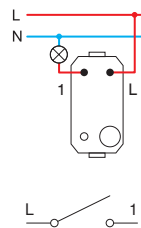

TIPKALO ENOPOLNO 16A 250V~ 1M



- SP11PC
- SP11PA
- SP11PB
- SP11PG

- tipkalo  
- 16A 250V~, tip SP11  
- ustreza EN 60669-1  
- vijajčna pritrditev vodnikov 1.5-2.5mm<sup>2</sup>  
**PUSH BUTTON 1WAY 16A 250V~ 1M**  
- push button  
- 16A 250V~, type SP11  
- in accordance with EN 60669-1  
- screw contacts 1.5-2.5mm<sup>2</sup>

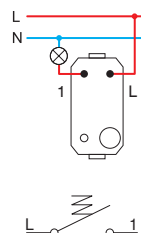

STIKALO ENOPOLNO 20A 250V~ 1M



- SP12PC
- SP12PA
- SP12PB
- SP12PG

- stikalo  
- 20A 250V~, tip SP12  
- ustreza EN 60669-1  
- vijajčna pritrditev vodnikov 1.5-2.5mm<sup>2</sup>  
**SWITCH 1WAY 20A 250V~ 1M**  
- switch  
- 20A 250V~, type SP12  
- in accordance with EN 60669-1  
- screw contacts 1.5-2.5mm<sup>2</sup>

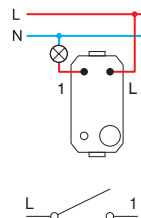

STIKALO DVOPOLNO 16AX 250V~ 1M



- SP20PC
- SP20PA
- SP20PB
- SP20PG

- stikalo  
- 16AX 250V~, tip SP20  
- ustreza EN 60669-1  
- vijajčna pritrditev vodnikov 1.5-2.5mm<sup>2</sup>  
**SWITCH 2POLE 16AX 250V~ 1M**  
- switch  
- 16AX 250V~, type SP20  
- in accordance with EN 60669-1  
- screw contacts 1.5-2.5mm<sup>2</sup>

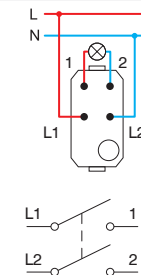

S W I T C H E S S P



- SP40PC
- SP40PA
- SP40PB
- SP40PG

STIKALO ŽALUZIJSKO 1-0-2 16AX 250V~ 1M

- stikalo
- 16AX 250V~, tip SP40
- ustreza EN 60669-1
- vijačna pritrditev vodnikov 1.5-2.5mm<sup>2</sup>

SWITCH SHUTTERS 1-0-2 16AX 250V~ 1M

- switch
- 16AX 250V~, type SP40
- in accordance with EN 60669-1
- screw contacts 1.5-2.5mm<sup>2</sup>

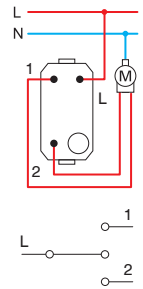

- SP41PC
- SP41PA
- SP41PB
- SP41PG

TIPKALO ŽALUZIJSKO 1-0-2 16A 250V~ 1M

- tipkalo
- 16A 250V~, tip SP41
- ustreza EN 60669-1
- vijačna pritrditev vodnikov 1.5-2.5mm<sup>2</sup>

PUSH BUTTON SHUTTERS 1-0-2 16A 250V~ 1M

- push button
- 16A 250V~, type SP41
- in accordance with EN 60669-1
- screw contacts 1.5-2.5mm<sup>2</sup>

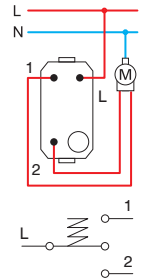

- SP60PC
- SP60PA
- SP60PB
- SP60PG

STIKALO MENJALNO 16AX 250V~ 1M

- stikalo
- 16AX 250V~, tip SP60
- ustreza EN 60669-1
- vijačna pritrditev vodnikov 1.5-2.5mm<sup>2</sup>

SWITCH 2WAY 16AX 250V~ 1M

- switch
- 16AX 250V~, type SP60
- in accordance with EN 60669-1
- screw contacts 1.5-2.5mm<sup>2</sup>

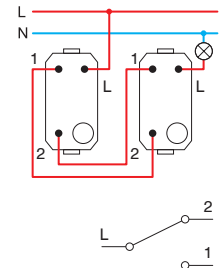

- SP61PC
- SP61PA
- SP61PB
- SP61PG

TIPKALO MENJALNO 16A 250V~ 1M

- tipkalo
- 16A 250V~, tip SP61
- ustreza EN 60669-1
- vijačna pritrditev vodnikov 1.5-2.5mm<sup>2</sup>

PUSH BUTTON 2WAY 16A 250V~ 1M

- push button
- 16A 250V~, type SP61
- in accordance with EN 60669-1
- screw contacts 1.5-2.5mm<sup>2</sup>

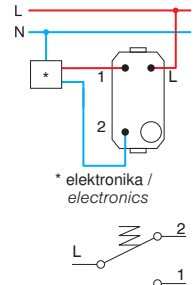

- SP70PC
- SP70PA
- SP70PB
- SP70PG

STIKALO KRIŽNO 16AX 250V~ 1M

- stikalo
- 16AX 250V~, tip SP70
- ustreza EN 60669-1
- vijačna pritrditev vodnikov 1.5-2.5mm<sup>2</sup>

SWITCH INTERMEDIATE 16AX 250V~ 1M

- switch
- 16AX 250V~, type SP70
- in accordance with EN 60669-1
- screw contacts 1.5-2.5mm<sup>2</sup>

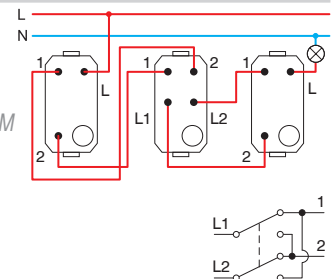

1M= 22,5 x 45

- SP10
- SP11
- SP12
- SP40
- SP41
- SP60
- SP61

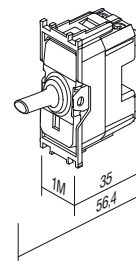

- SP20
- SP70

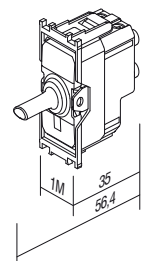

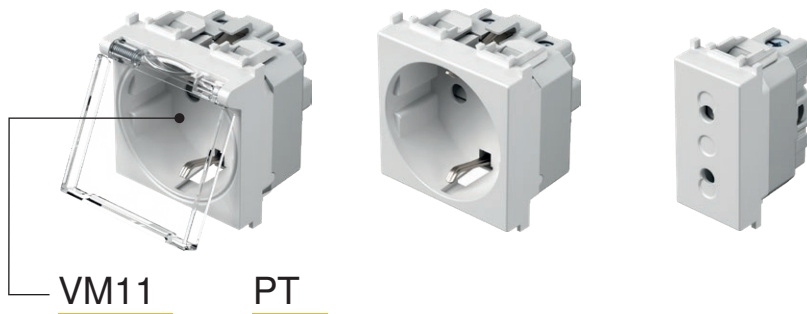

tip type	naziv description	tehnični opis technical data	velikost size	barva colour																					
VM10	VTIČNICA SCHUKO+KS SOCKET SCHUKO+KS	2P+E 16A 250V~	2M	<table border="0"> <tr> <td><input type="checkbox"/> PW bela-sijaj polar white</td> <td><input checked="" type="checkbox"/> PT bela+prozorna white+transparent</td> <td><input type="checkbox"/> PP bela+bela white+white</td> </tr> </table>	<input type="checkbox"/> PW bela-sijaj polar white	<input checked="" type="checkbox"/> PT bela+prozorna white+transparent	<input type="checkbox"/> PP bela+bela white+white																		
<input type="checkbox"/> PW bela-sijaj polar white	<input checked="" type="checkbox"/> PT bela+prozorna white+transparent	<input type="checkbox"/> PP bela+bela white+white																							
VM11	VTIČNICA SCHUKO+KS+POKROV SOCKET SCHUKO+KS+COVER	2P+E 16A 250V~	2M	<table border="0"> <tr> <td><input type="checkbox"/> MW bela- mat matte white</td> <td><input checked="" type="checkbox"/> MT bela+prozorna white+transparent</td> <td><input type="checkbox"/> MM bela+bela white+white</td> </tr> </table>	<input type="checkbox"/> MW bela- mat matte white	<input checked="" type="checkbox"/> MT bela+prozorna white+transparent	<input type="checkbox"/> MM bela+bela white+white																		
<input type="checkbox"/> MW bela- mat matte white	<input checked="" type="checkbox"/> MT bela+prozorna white+transparent	<input type="checkbox"/> MM bela+bela white+white																							
VM20	VTIČNICA EURO+KS SOCKET EURO+KS	2P 10A 250V~	1M	<table border="0"> <tr> <td><input checked="" type="checkbox"/> SB črna-mat soft touch black</td> <td><input checked="" type="checkbox"/> BT črna+prozorna black+transparent</td> <td><input checked="" type="checkbox"/> BB črna+črna soft touch black+black</td> </tr> <tr> <td><input checked="" type="checkbox"/> AT antracit anthracite</td> <td><input checked="" type="checkbox"/> AT antracit+prozorna anthracite+transparent</td> <td><input checked="" type="checkbox"/> AA antracit+antracit anthracite+anthracite</td> </tr> <tr> <td><input checked="" type="checkbox"/> ES srebrna elox silver</td> <td><input checked="" type="checkbox"/> ST srebrna+prozorna silver+transparent</td> <td><input checked="" type="checkbox"/> SS srebrna+srebrna silver+silver</td> </tr> <tr> <td><input checked="" type="checkbox"/> IW bež-sijaj ivory white</td> <td><input checked="" type="checkbox"/> IT bež+prozorna ivory+transparent</td> <td><input checked="" type="checkbox"/> II bež+bež ivory+ivory</td> </tr> <tr> <td><input checked="" type="checkbox"/> RD rdeča red</td> <td><input checked="" type="checkbox"/> RT rdeča+prozorna red+transparent</td> <td><input checked="" type="checkbox"/> RR rdeča+rdeča red+red</td> </tr> <tr> <td><input checked="" type="checkbox"/> GR zelena green</td> <td><input checked="" type="checkbox"/> GT zelena+prozorna green+transparent</td> <td><input checked="" type="checkbox"/> GG zelena+zelena green+green</td> </tr> <tr> <td><input checked="" type="checkbox"/> OR oranžna orange</td> <td><input checked="" type="checkbox"/> OT oranžna+prozorna orange+transparent</td> <td><input checked="" type="checkbox"/> OO oranžna+oranžna orange+orange</td> </tr> </table>	<input checked="" type="checkbox"/> SB črna-mat soft touch black	<input checked="" type="checkbox"/> BT črna+prozorna black+transparent	<input checked="" type="checkbox"/> BB črna+črna soft touch black+black	<input checked="" type="checkbox"/> AT antracit anthracite	<input checked="" type="checkbox"/> AT antracit+prozorna anthracite+transparent	<input checked="" type="checkbox"/> AA antracit+antracit anthracite+anthracite	<input checked="" type="checkbox"/> ES srebrna elox silver	<input checked="" type="checkbox"/> ST srebrna+prozorna silver+transparent	<input checked="" type="checkbox"/> SS srebrna+srebrna silver+silver	<input checked="" type="checkbox"/> IW bež-sijaj ivory white	<input checked="" type="checkbox"/> IT bež+prozorna ivory+transparent	<input checked="" type="checkbox"/> II bež+bež ivory+ivory	<input checked="" type="checkbox"/> RD rdeča red	<input checked="" type="checkbox"/> RT rdeča+prozorna red+transparent	<input checked="" type="checkbox"/> RR rdeča+rdeča red+red	<input checked="" type="checkbox"/> GR zelena green	<input checked="" type="checkbox"/> GT zelena+prozorna green+transparent	<input checked="" type="checkbox"/> GG zelena+zelena green+green	<input checked="" type="checkbox"/> OR oranžna orange	<input checked="" type="checkbox"/> OT oranžna+prozorna orange+transparent	<input checked="" type="checkbox"/> OO oranžna+oranžna orange+orange
<input checked="" type="checkbox"/> SB črna-mat soft touch black	<input checked="" type="checkbox"/> BT črna+prozorna black+transparent	<input checked="" type="checkbox"/> BB črna+črna soft touch black+black																							
<input checked="" type="checkbox"/> AT antracit anthracite	<input checked="" type="checkbox"/> AT antracit+prozorna anthracite+transparent	<input checked="" type="checkbox"/> AA antracit+antracit anthracite+anthracite																							
<input checked="" type="checkbox"/> ES srebrna elox silver	<input checked="" type="checkbox"/> ST srebrna+prozorna silver+transparent	<input checked="" type="checkbox"/> SS srebrna+srebrna silver+silver																							
<input checked="" type="checkbox"/> IW bež-sijaj ivory white	<input checked="" type="checkbox"/> IT bež+prozorna ivory+transparent	<input checked="" type="checkbox"/> II bež+bež ivory+ivory																							
<input checked="" type="checkbox"/> RD rdeča red	<input checked="" type="checkbox"/> RT rdeča+prozorna red+transparent	<input checked="" type="checkbox"/> RR rdeča+rdeča red+red																							
<input checked="" type="checkbox"/> GR zelena green	<input checked="" type="checkbox"/> GT zelena+prozorna green+transparent	<input checked="" type="checkbox"/> GG zelena+zelena green+green																							
<input checked="" type="checkbox"/> OR oranžna orange	<input checked="" type="checkbox"/> OT oranžna+prozorna orange+transparent	<input checked="" type="checkbox"/> OO oranžna+oranžna orange+orange																							



VTIČNICA SCHUKO+KS 2P+E 16A 250V~ 2M

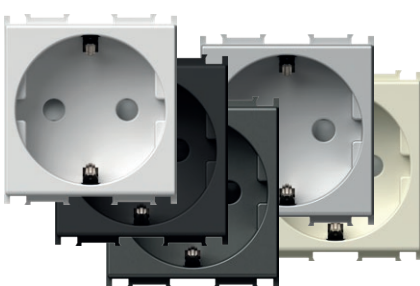

- VM10PW
- VM10MW
- VM10SB
- VM10AT
- VM10ES
- VM10IW

- 2P+E schuko
- 16A 250V~, tip VM10
- ustreza IEC 60884-1, CEE7
- vijajčna pritrditev vodnikov 1.5-2.5 mm<sup>2</sup>
- vgrajena zaščita pred dotikom kontaktov

SOCKET SCHUKO+KS 2P+E 16A 250V~ 2M

- 2P+E schuko
- 16A 250V~, type VM10
- in accordance with IEC 60884-1, CEE7
- screw contacts 1.5-2.5 mm<sup>2</sup>
- shuttered live contacts



VTIČNICA SCHUKO+KS 2P+E 16A 250V~ 2M

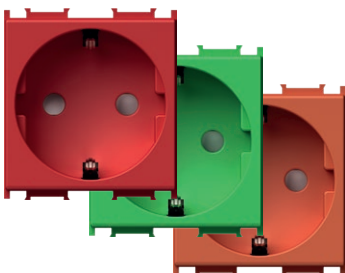

- VM10RD
- VM10GR
- VM10OR

- 2P+E schuko
- 16A 250V~, tip VM10
- ustreza IEC 60884-1, CEE7
- vijajčna pritrditev vodnikov 1.5-2.5 mm<sup>2</sup>
- vgrajena zaščita pred dotikom kontaktov

SOCKET SCHUKO+KS 2P+E 16A 250V~ 2M

- 2P+E schuko
- 16A 250V~, type VM10
- in accordance with IEC 60884-1, CEE7
- screw contacts 1.5-2.5 mm<sup>2</sup>
- shuttered live contacts



VTIČNICA SCHUKO+KS+POKROV 2P+E 16A 250V~ 2M

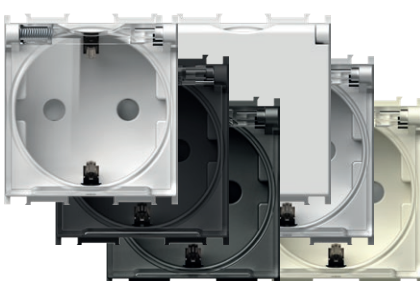

- VM11PT
- VM11MT
- VM11BT
- VM11AT
- VM11ST
- VM11IT
- VM11PP

- 2P+E schuko+pokrov
- 16A 250V~, tip VM11
- ustreza IEC 60884-1, CEE7
- vijajčna pritrditev vodnikov 1.5-2.5 mm<sup>2</sup>
- vgrajena zaščita pred dotikom kontaktov

SOCKET SCHUKO+KS+COVER

- 2P+E 16A 250V~ 2M
- 2P+E schuko+cover
- 16A 250V~, type VM11
- in accordance with IEC 60884-1, CEE7
- screw contacts 1.5-2.5 mm<sup>2</sup>
- shuttered live contacts





## S O C K E T S V M

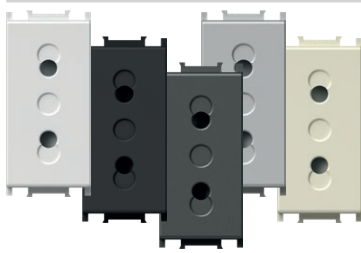

- VM20PW
- VM20MW
- VM20SB
- VM20AT
- VM20ES
- VM20IW

## VTIČNICA EURO+KS 2P 10A 250V~ 1M

- 2P euro
- 10A 250V~, tip VM20
- ustreza IEC 60884-1, CEE7
- vijačna pritrnitev vodnikov 1.5-2.5 mm<sup>2</sup>
- vgrajena zaščita pred dotikom kontaktov



## SOCKET EURO+KS 2P 10A 250V~ 1M

- 2P Euro
- 10A 250V~, type VM20
- in accordance with IEC 60884-1, CEE7
- screw contacts 1.5-2.5 mm<sup>2</sup>
- shuttered live contacts

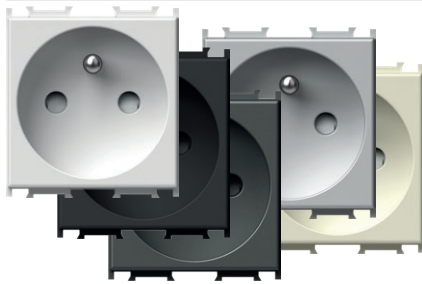

- VM40PW
- VM40MW
- VM40SB
- VM40AT
- VM40ES
- VM40IW

## VTIČNICA FRANCOSKA+KS 2P+E 16A 250V~ 2M

- 2P+E francoska
- 16A 250V~, tip VM40
- ustreza IEC 60884-1, NF C 61-314, CEE7
- vijačna pritrnitev vodnikov 1.5-2.5 mm<sup>2</sup>
- vgrajena zaščita pred dotikom kontaktov



## SOCKET FRENCH+KS 2P+E 16A 250V~ 2M

- 2P+E French
- 16A 250V~, type VM40
- in accordance with IEC 60884-1, NF C 61-314, CEE7
- screw contacts 1.5-2.5 mm<sup>2</sup>
- shuttered live contacts

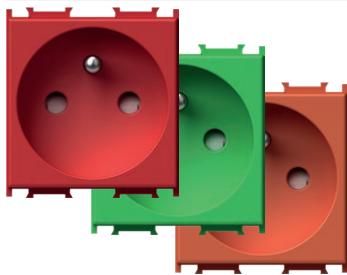

- VM40RD
- VM40GR
- VM40OR

## VTIČNICA FRANCOSKA+KS 2P+E 16A 250V~ 2M

- 2P+E francoska
- 16A 250V~, tip VM40
- ustreza IEC 60884-1, NF C 61-314, CEE7
- vijačna pritrnitev vodnikov 1.5-2.5 mm<sup>2</sup>
- vgrajena zaščita pred dotikom kontaktov



## SOCKET FRENCH+KS 2P+E 16A 250V~ 2M

- 2P+E French
- 16A 250V~, type VM40
- in accordance with IEC 60884-1, NF C 61-314, CEE7
- screw contacts 1.5-2.5 mm<sup>2</sup>
- shuttered live contacts



- VM41PT
- VM41MT
- VM41BT
- VM41AT
- VM41PP
- VM41ST
- VM41IT

## VTIČNICA FRANCOSKA+KS+POKROV 2P+E 16A 250V~ 2M

- 2P+E francoska+pokrov
- 16A 250V~, tip VM41
- ustreza IEC 60884-1, NF C 61-314, CEE7
- vijačna pritrnitev vodnikov 1.5-2.5 mm<sup>2</sup>
- vgrajena zaščita pred dotikom kontaktov



## SOCKET FRENCH+KS+COVER 2P+E 16A 250V~ 2M

- 2P+E French+cover
- 16A 250V~, type VM41
- in accordance with IEC 60884-1, NF C 61-314, CEE7
- screw contacts 1.5-2.5 mm<sup>2</sup>
- shuttered live contacts

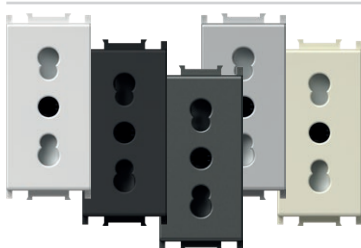

- VM30PW
- VM30MW
- VM30SB
- VM30AT
- VM30ES
- VM30IW

## VTIČNICA ITALIJANSKA P17/11+KS 2P+E 16A 250V~ 1M

- 2P+E italijanska P17/11
- 16A 250V~, tip VM30
- ustreza IEC 60884-1, CEI 23-50
- vijačna pritrnitev vodnikov 1.5-2.5 mm<sup>2</sup>
- vgrajena zaščita pred dotikom kontaktov



## SOCKET ITALIAN P17/11+KS 2P+E 16A 250V~ 1M

- 2P+E Italian P17/11
- 16A 250V~, type VM30
- in accordance with IEC 60884-1, CEI 23-50
- screw contacts 1.5-2.5 mm<sup>2</sup>
- shuttered live contacts

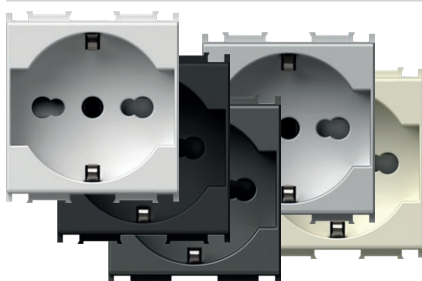

- VM31PW
- VM31MW
- VM31SB
- VM31AT
- VM31ES
- VM31IW

## VTIČNICA SCHUKO/ITA P17/11+KS 2P+E 16A 250V~ 2M

- 2P+E schuko/italijanska P17/11
- 16A 250V~, tip VM31
- ustreza IEC 60884-1, CEI 23-50
- vijačna pritrnitev vodnikov 1.5-2.5 mm<sup>2</sup>
- vgrajena zaščita pred dotikom kontaktov

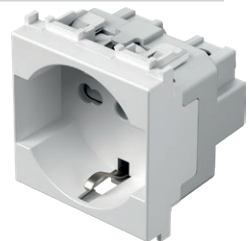

## SOCKET SCHUKO/ITA P17/11+KS 2P+E 16A 250V~ 2M

- 2P+E schuko/Italian P17/11
- 16A 250V~, type VM31
- in accordance with IEC 60884-1, CEI 23-50
- screw contacts 1.5-2.5 mm<sup>2</sup>
- shuttered live contacts

VTIČNICA SCHUKO/ITA P30+KS 2P+E 16A 250V~ 2M

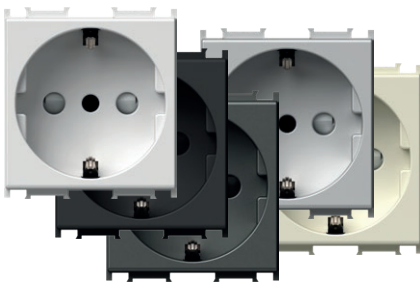

- VM32PW
- VM32MW
- VM32SB
- VM32AT
- VM32ES
- VM32IW

- 2P+E schuko/italijanska P30
- 16A 250V~, tip VM32
- ustreza IEC 60884-1, CEI 23-50
- vijajčna pritrditvev vodnikov 1.5-2.5 mm<sup>2</sup>
- vgrajena zaščita pred dotikom kontaktov



SOCKET SCHUKO/ITA P30+KS 2P+E 16A 250V~ 2M

- 2P+E schuko/Italian P30
- 16A 250V~, type VM32
- in accordance with IEC 60884-1, CEI 23-50
- screw contacts 1.5-2.5 mm<sup>2</sup>
- shuttered live contacts

VTIČNICA ITALIJANSKA P11+KS 2P+E 10A 250V~ 1M



- VM33PW
- VM33MW
- VM33SB
- VM33AT
- VM33ES
- VM33IW

- 2P+E italijanska P11
- 10A 250V~, tip VM33
- ustreza IEC 60884-1, CEI 23-50
- vijajčna pritrditvev vodnikov 1.5-2.5 mm<sup>2</sup>
- vgrajena zaščita pred dotikom kontaktov



SOCKET ITALIAN P11+KS 2P+E 10A 250V~ 1M

- 2P+E Italian P11
- 10A 250V~, type VM33
- in accordance with IEC 60884-1, CEI 23-50
- screw contacts 1.5-2.5 mm<sup>2</sup>
- shuttered live contacts

VTIČNICA EURO/AMERIŠKA+KS 2P 16A 250V~ 1M

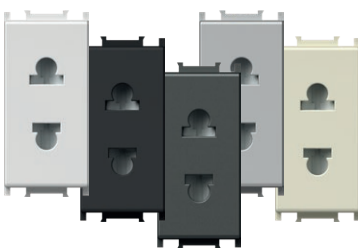

- VM21PW
- VM21MW
- VM21SB
- VM21AT
- VM21ES
- VM21IW

- 2P euro/ameriška
- 16A 250V~, tip VM21
- vijajčna pritrditvev vodnikov 1.5-2.5 mm<sup>2</sup>
- vgrajena zaščita pred dotikom kontaktov
- samo za države izven EU



SOCKET EURO/AMERICAN+KS 2P 16A 250V~ 1M

- 2P Euro/American
- 16A 250V~, type VM21
- screw contacts 1.5-2.5 mm<sup>2</sup>
- shuttered live contacts
- only for countries not members of EU

VTIČNICA BRITANSKA BS 1363-2+KS 2P+E 13A 250V~ 2M

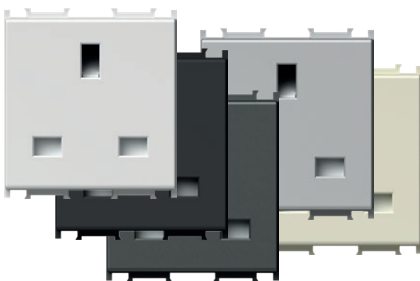

- VM52PW
- VM52MW
- VM52SB
- VM52AT
- VM52ES
- VM52IW

- 2P+E britanski standard BS 1363-2
- 13A/250V~, tip VM52
- ustreza BS 1363-2
- vijajčna pritrditvev vodnikov 1.5-4 mm<sup>2</sup>
- vgrajena zaščita pred dotikom kontaktov

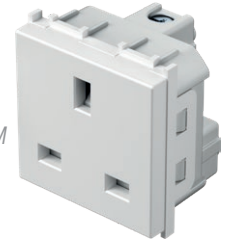

SOCKET BRITISH BS 1363-2+KS 2P+E 13A 250V~ 2M

- 2P+E British BS 1363-2
- 13A 250V~, type VM52
- in accordance with BS 1363-2
- screw contacts 1.5-4 mm<sup>2</sup>
- shuttered live contacts

VTIČNICA VEČSTANDARDNA+KS 2P+E 13A 250V~ 2M



- VM55PW
- VM55MW
- VM55SB
- VM55AT
- VM55ES
- VM55IW

- brezvijajčna pritrditvev vodnikov 1.5-2.5mm<sup>2</sup>
- vgrajena zaščita pred dotikom kontaktov

SOCKET MULTI-STANDARD+KS 2P+E 13A 250V~ 2M

- plug-in contacts 1.5-2.5 mm<sup>2</sup>
- shuttered live contacts



PRENAPETOSTNA ZAŠČITA MPE MINI 275V/50Hz



VM80

- vzporedna vezava s prvo vtičnico v seriji
- razred zaščite III
- U<sub>c</sub>=275V~, U<sub>oc</sub>/I<sub>sc</sub>=6kV/3kA, U<sub>p</sub><800V
- ustreza IEC 61643-1
- vodniki 1.5mm<sup>2</sup>, IP20
- zvočni signal ob uničenju





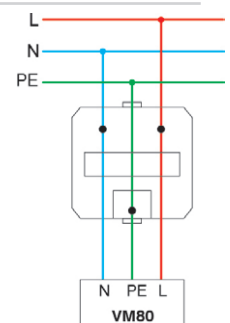









SURGE PROTECTOR MPE MINI 275V/50Hz

- parallel connection with the first socket in the row
- protection class III
- U<sub>c</sub>=275V~, U<sub>oc</sub>/I<sub>sc</sub>=6kV/3kA, U<sub>p</sub><800V
- in accordance with IEC 61643-1
- wires 1.5mm<sup>2</sup>, IP20
- sound signal at breakdown







## S O C K E T S V M

 UJEMANJE VTIČNIC IN VTIČEV  
 SOCKETS AND PLUGS MATCHING

VTIČNICA / SOCKET									
STIL VTIČA / PLUG STYLE	VM10 VM11	VM20	VM30	VM33	VM31	VM32	VM40 VM41	VM21	VM55
nemški / German 	•				•	•			•
francoski / French 	•				•	•	•		•
italijanski / Italian S11 			•	•	•	•			•
italijanski / Italian S17 			•		•				•
euro 	•	•	•		•	•	•	•	•

 UJEMANJE VTIČNIC IN VTIČEV  
 SOCKETS AND PLUGS MATCHING

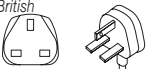
VTIČNICA / SOCKET			
STIL VTIČA / PLUG STYLE	VM21	VM52	VM55
ameriški / American 	•		•
britanski / British BS 1363-2 		•	•

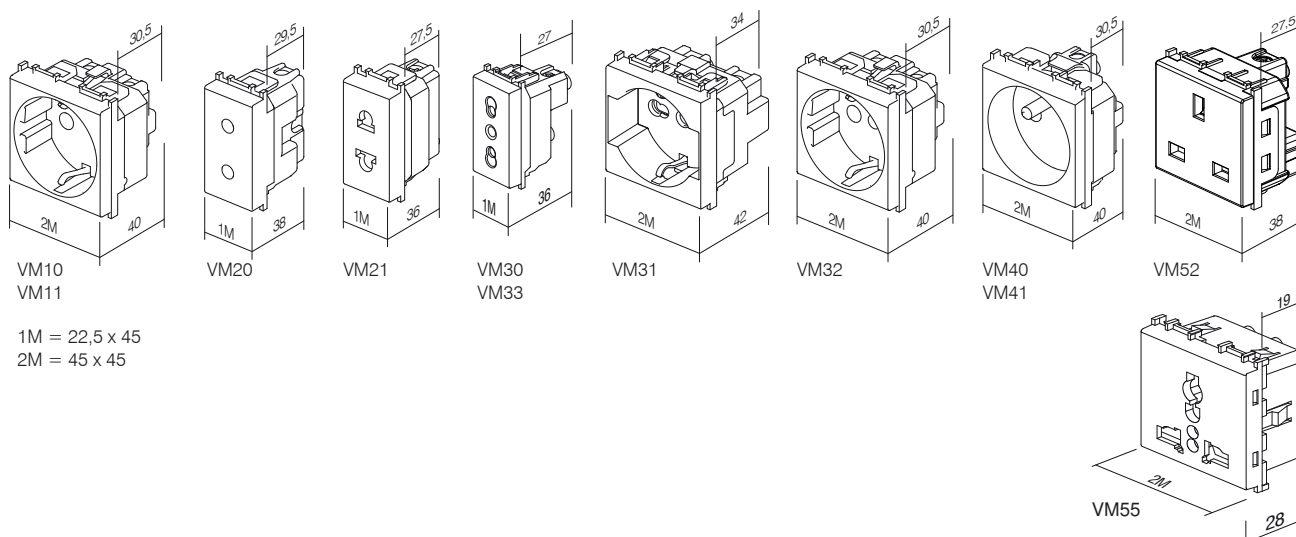



tip type	naziv description	tehnični opis technical data	velikost size	barva colour
KM10	VTIČNICA TV OSNOVNA SOCKET TV BASIC	0dB	1M	<input type="checkbox"/> PW bela-sijaj polar white
KM11	VTIČNICA TV KONČNA SOCKET TV END-LINE	1dB	1M	<input type="checkbox"/> MW bela-mat matte white
KM12	VTIČNICA TV PREHODNA SOCKET TV TROUGHPASS	10dB	1M	<input checked="" type="checkbox"/> SB črna-mat soft touch black
:	:	:	:	<input checked="" type="checkbox"/> AT antracit anthracite
:	:	:	:	<input type="checkbox"/> ES srebrna elox silver
:	:	:	:	<input type="checkbox"/> IW bež-sijaj ivory white

VTIČNICA TV OSNOVNA 0dB 1M



- KM10PW
- KM10MW
- KM10SB
- KM10AT
- KM10ES
- KM10IW

- TV osnovna
  - dušenje 0dB
  - konektor zadaj – F standard
- SOCKET TV BASIC 0dB 1M*
- TV basic
  - reduction 0dB
  - back connector – F standard



VTIČNICA TV OSNOVNA 0dB 2M

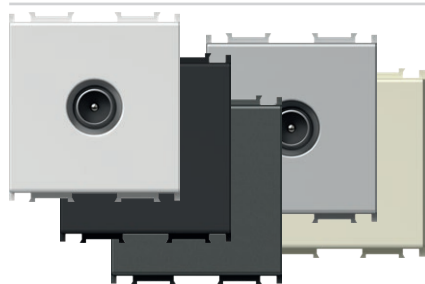

- KM20PW
- KM20MW
- KM20SB
- KM20AT
- KM20ES
- KM20IW

- TV osnovna
  - dušenje 0dB
  - konektor zadaj – F standard
- SOCKET TV BASIC 0dB 2M*
- TV basic
  - reduction 0dB
  - back connector – F standard



VTIČNICA TV KONČNA 1dB 1M



- KM11PW
- KM11MW
- KM11SB
- KM11AT
- KM11ES
- KM11IW

- TV končna
  - frekvenčni pas 5÷2400 MHz
  - dušenje < 1 dB
  - ustreza EN 50083-1
  - vijačna priključitev
- SOCKET TV END-LINE 1dB 1M*
- TV end-line
  - frequency range 5÷2400 MHz
  - reduction < 1 dB
  - in accordance with EN 50083-1
  - screw contacts

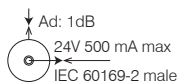

## VTIČNICA TV PREHODNA 10dB 1M



- KM12PW
- KM12MW
- KM12SB
- KM12AT
- KM12ES
- KM12IW

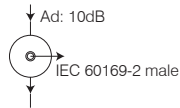

- TV prehodna
- frekvenčni pas 5÷2400 MHz
- dušenje < 10 dB
- ustreza EN 50083-1
- vijačna priključitev

## SOCKET TV TROUGH-PASS 10dB 1M

- TV troughpass
- frequency range 5÷2400 MHz
- reduction < 10 dB
- in accordance with EN 50083-1
- screw contacts



## VTIČNICA SAT OSNOVNA 0dB 1M



- KM15PW
- KM15MW
- KM15SB
- KM15AT
- KM15ES
- KM15IW

- SAT osnovna
- dušenje 0dB
- konektor zadaj – F standard

## SOCKET SAT BASIC 0dB 1M

- SAT basic
- reduction 0dB
- back connector – F standard



## VTIČNICA SAT OSNOVNA 0dB 2M

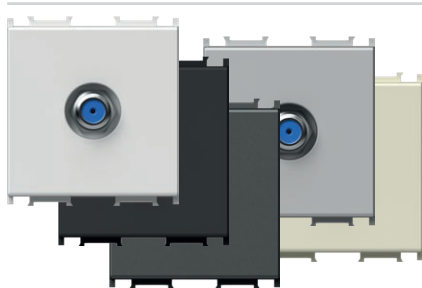

- KM24PW
- KM24MW
- KM24SB
- KM24AT
- KM24ES
- KM24IW

- SAT osnovna
- dušenje 0dB
- konektor zadaj – F standard

## SOCKET SAT BASIC 0dB 2M

- SAT basic
- reduction 0dB
- back connector – F standard



## VTIČNICA SAT KONČNA 1dB 1M

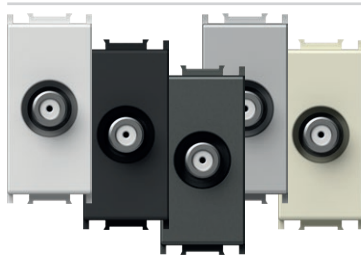

- KM16PW
- KM16MW
- KM16SB
- KM16AT
- KM16ES
- KM16IW

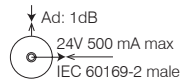

- SAT končna
- frekvenčni pas 5÷2400 MHz
- dušenje < 1dB
- ustreza EN 50083-1
- vijačna priključitev

## SOCKET SAT END-LINE 1dB 1M

- SAT end-line
- frequency range 5÷2400 MHz
- reduction < 1dB
- in accordance with EN 50083-1
- screw contacts



VTIČNICA R OSNOVNA 0dB 1M



- KM19PW
- KM19MW
- KM19SB
- KM19AT
- KM19ES
- KM19IW

- R osnovna
  - dušenje 0dB
  - konektor zadaj – F standard
- SOCKET R BASIC 0dB 1M*
- R basic
  - reduction 0dB
  - back connector – F standard



VTIČNICA R OSNOVNA 0dB 2M

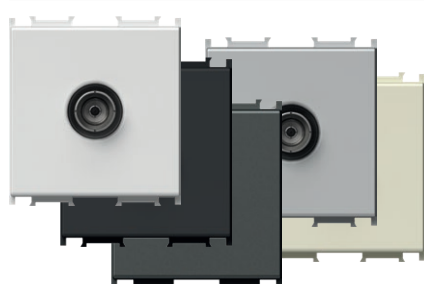

- KM29PW
- KM29MW
- KM29SB
- KM29AT
- KM29ES
- KM29IW

- R osnovna
  - dušenje 0dB
  - konektor zadaj – F standard
- SOCKET R BASIC 0dB 2M*
- R basic
  - reduction 0dB
  - back connector – F standard



VTIČNICA SAT-TV KONČNA 1dB 1M



- KM17PW
- KM17MW
- KM17SB
- KM17AT
- KM17ES
- KM17IW

- SAT-TV končna
- frekvenčni pas 5÷2400 MHz
- dušenje < 1dB
- ustreza EN 50083-1
- vijajčna priključitev

*SOCKET SAT-TV END-LINE 1dB 1M*

- SAT-TV end-line
- frequency range 5÷2400 MHz
- reduction < 1dB
- in accordance with EN 50083-1
- screw contacts

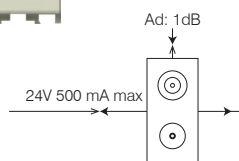

OSNOVNE VEZALNE SCHEME  
BASIC CONNECTION SAMPLES

samostojna vezava  
stand alone connection

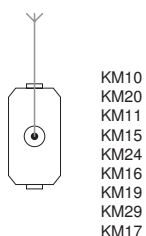

zvezda vezava  
star connection

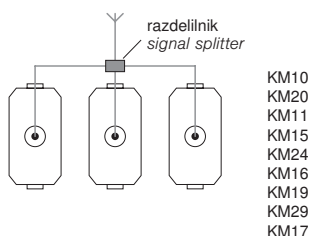

prehodna vezava  
throughpass connection

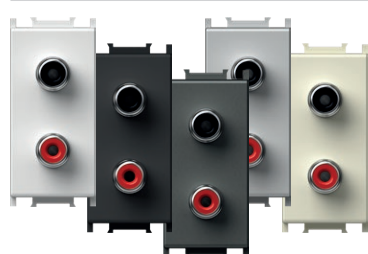
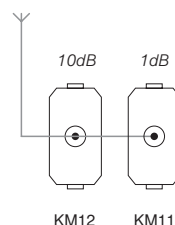

- KM22PW
- KM22MW
- KM22SB
- KM22AT
- KM22ES
- KM22IW

VTIČNICA AVDIO 2xRCA 1M

- avdio 2x RCA
- pritrditev vodnikov zadaj s spajkanjem

SOCKET AUDIO 2xRCA 1M

- audio 2x RCA
- soldering connection of cable at the back side



- KM23PW
- KM23MW
- KM23SB
- KM23AT
- KM23ES
- KM23IW

VTIČNICA AVDIO ZVOČNIŠKA 1M

- avdio 2x Ø4mm
- za priklop zvočniškega vodnika, vtiča Ø4mm ali viličastega kabel čevlja
- pritrditev vodnikov zadaj s spajkanjem

SOCKET AUDIO LOUDSPEAKERS 1M

- audio 2x Ø4mm
- to accommodate speaker wire, banana plug Ø4mm or spades
- soldering connection of cable at the back side



- KM26PW
- KM26MW
- KM26SB
- KM26AT
- KM26ES
- KM26IW

VTIČNICA AVDIO ZVOČNIŠKA 2M

- avdio 2x Ø4mm
- za priklop zvočniškega vodnika, vtiča Ø4mm ali viličastega kabel čevlja
- pritrditev vodnikov zadaj s spajkanjem

SOCKET AUDIO LOUDSPEAKERS 2M

- audio 2x Ø4mm
- to accommodate speaker wire, banana plug Ø4mm or spades
- soldering connection of cable at the back side



1M = 22,5 x 45  
2M = 45 x 45

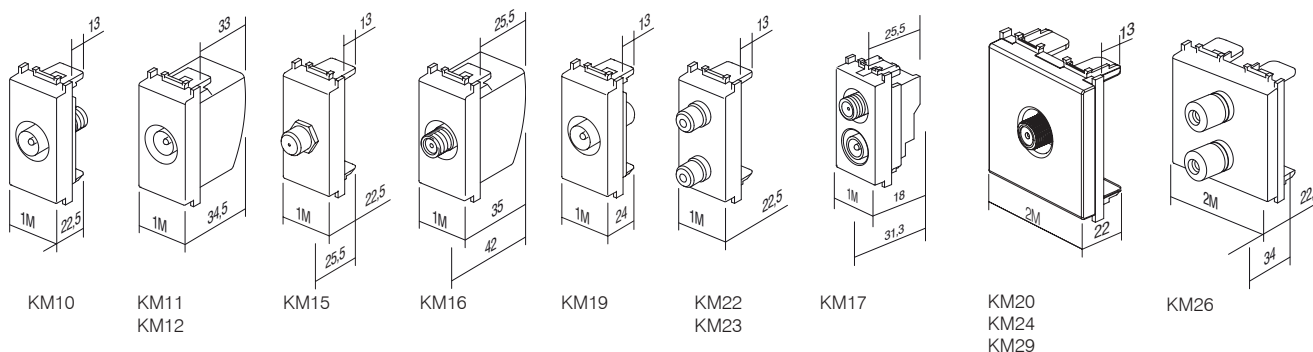

VTIČNICA TEL LT RJ11 6/4 1M



- KM30PW
- KM30MW
- KM30SB
- KM30AT
- KM30ES
- KM30IW

- TEL LT vijak
- RJ11 6/4
- ustreza IEC 60603-7
- vijačna pritrditev vodnikov

*SOCKET TEL LT RJ11 6/4 1M*

- TEL LT screw
- RJ11 6/4
- in accordance with IEC 60603-7
- screw contacts



VTIČNICA TEL BT SEC 6/6 1M

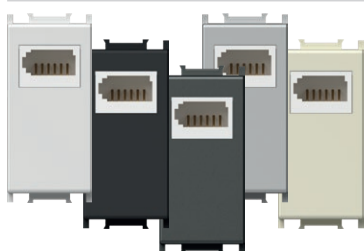

- KM31PW
- KM31MW
- KM31SB
- KM31AT
- KM31ES
- KM31IW

- TEL BT britanski standard
- SEC sekundarna 6/6
- ustreza BS 6312
- vijačna pritrditev vodnikov

*SOCKET TEL BT SEC 6/6 1M*

- TEL BT British standard
- SEC secondary 6/6
- in accordance with BS 6312
- screw contacts



VTIČNICA TEL KS RJ11 6/4 1M

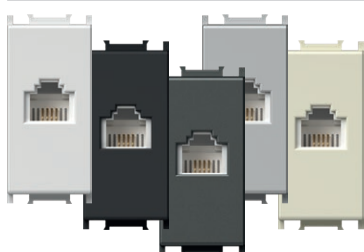

- KM36PW
- KM36MW
- KM36SB
- KM36AT
- KM36ES
- KM36IW

- KS keystone pritrditveni standard
- RJ11 6/4
- ustreza IEC 60603-7

*SOCKET TEL KS RJ11 6/4 1M*

- KS keystone fixing standard
- RJ11 6/4
- in accordance with IEC 60603-7

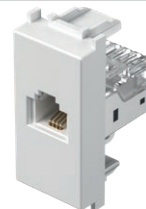

VTIČNICA CAT5e KS RJ45 8/8 1M

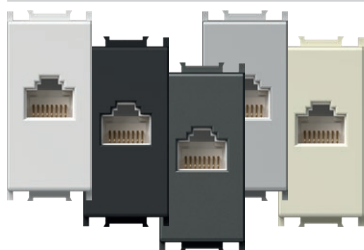

- KM37PW
- KM37MW
- KM37SB
- KM37AT
- KM37ES
- KM37IW

- KS keystone pritrditveni standard
- CAT5e, RJ45 8/8
- ustreza IEC 60603-7

*SOCKET CAT5e KS RJ45 8/8 1M*

- KS keystone fixing standard
- CAT5e, RJ45 8/8
- in accordance with IEC 60603-7

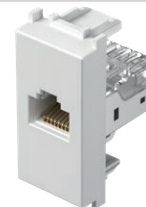

ADAPTER KS 1M

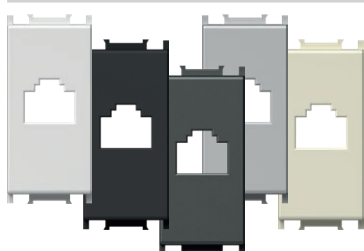

- KM35PW
- KM35MW
- KM35SB
- KM35AT
- KM35ES
- KM35IW

- KS keystone pritrditveni standard
- AMP, Avaya, Brandrex, FMT, Mfico, Tyco, ...
- komunikacijski modul ni vgrajen

*ADAPTER KS 1M*

- KS keystone fixing standard
- AMP, Avaya, Brandrex, FMT, Mfico, Tyco, ...
- communication module not included

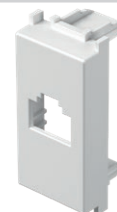

ADAPTER KS S PRAŠNO ZAŠČITO 1M

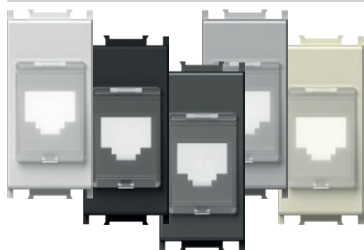

- KM38PW
- KM38MW
- KM38SB
- KM38AT
- KM38ES
- KM38IW

- KS keystone pritrditveni standard s protiprašnim pokrovom
- AMP, Avaya, Brandrex, FMT, Mfico, Tyco, ...
- komunikacijski modul ni vgrajen

*ADAPTER KS WITH DUST PROTECTION 1M*

- KS keystone fixing standard with dust protection
- AMP, Avaya, Brandrex, FMT, Mfico, Tyco, ...
- communication module not included





## VTIČNICA CAT6 SCH KS RJ45 8/8 1M

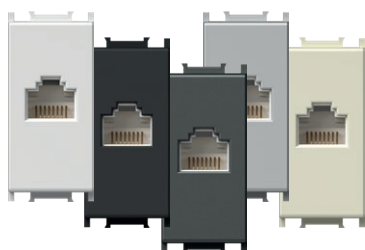

- KM39PW
- KM39MW
- KM39SB
- KM39AT
- KM39ES
- KM39IW

- KS keystone pritrditveni standard
- CAT6 UTP toolless, RJ45 8/8
- ustreza ISO/IEC 11801

## SOCKET CAT6 SCH KS RJ45 8/8 1M

- KS keystone fixing standard
- CAT6 UTP toolless, RJ45 8/8
- in accordance with ISO/IEC 11801



## ADAPTER KS UNIVERZALNI 1M

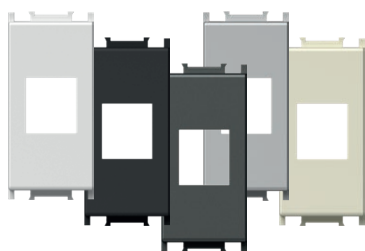

- KM50PW
- KM50MW
- KM50SB
- KM50AT
- KM50ES
- KM50IW

- KS keystone pritrditveni standard
- primeren za HDMI, USB
- komunikacijski modul ni vgrajen

## ADAPTER KS UNIVERSAL 1M

- KS keystone fixing standard
- suitable for HDMI, USB
- communication module not included



## ADAPTER PD 1M

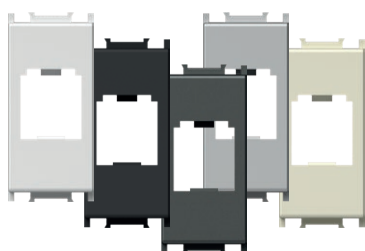

- KM40PW
- KM40MW
- KM40SB
- KM40AT
- KM40ES
- KM40IW

- PD Panduit Mini-COM pritrditveni standard
- komunikacijski modul ni vgrajen

## ADAPTER PD 1M

- PD Panduit Mini-COM fixing standard
- communication module not included



## ADAPTER PD S PRAŠNO ZAŠČITO 1M



- KM43PW
- KM43MW
- KM43SB
- KM43AT
- KM43ES
- KM43IW

- PD Panduit Mini-COM pritrditveni standard s protiprašnim pokrovom
- komunikacijski modul ni vgrajen

## ADAPTER PD WITH DUST PROTECTION 1M

- PD Panduit Mini-COM fixing standard with dust protection
- communication module not included



#### ADAPTER R&M 1M

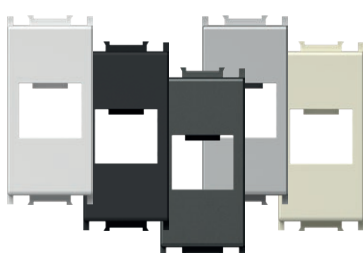

- KM46PW
- KM46MW
- KM46SB
- KM46AT
- KM46ES
- KM46IW

- R&M pritrditveni standard
- komunikacijski modul ni vgrajen

#### *ADAPTER R&M 1M*

- R&M fixing standard
- communication module not included



#### ADAPTER R&M CAT6A 1M

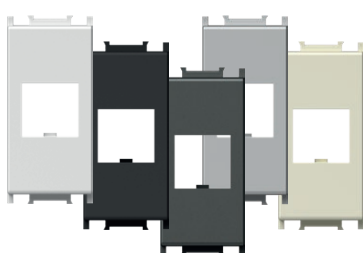

- KM52PW
- KM52MW
- KM52SB
- KM52AT
- KM52ES
- KM52IW

- R&M pritrditev za CAT6A
- komunikacijski modul ni vgrajen

#### *ADAPTER R&M CAT6A 1M*

- R&M fixing for CAT6A
- communication module not included



#### ADAPTER R&M S PRAŠNO ZAŠČITO 1M



- KM47PW
- KM47MW
- KM47SB
- KM47AT
- KM47ES
- KM47IW

- R&M pritrditveni standard s protiprašnim pokrovom
- komunikacijski modul ni vgrajen

#### *ADAPTER R&M WITH DUST PROTECTION 1M*

- R&M fixing standard with dust protection
- communication module not included



#### ADAPTER R&M CAT6A S PRAŠNO ZAŠČITO 1M



- KM53PW
- KM53MW
- KM53SB
- KM53AT
- KM53ES
- KM53IW

- R&M pritrditev za CAT6A s protiprašnim pokrovom
- komunikacijski modul ni vgrajen

#### *ADAPTER R&M CAT6A WITH DUST PROTECTION 1M*

- R&M fixing for CAT6A with dust protection
- communication module not included



## ADAPTER LK 1M

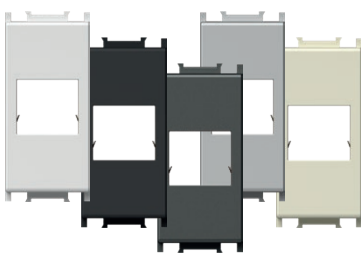

- KM45PW
- KM45MW
- KM45SB
- KM45AT
- KM45ES
- KM45IW

- LK Leonikerpen eLine / BKS NewLine pritrditveni standard  
- komunikacijski modul ni vgrajen

## ADAPTER LK 1M

- LK Leonikerpen eLine / BKS NewLine fixing standard  
- communication module not included



## ADAPTER NEXANS/SCHRACK 2M

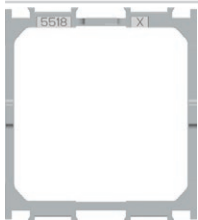

KA26

- adapter za pritrnitev modulov Nexans LANmark in Schrack velikosti 45x45mm  
- primerna za Nexans tip N423.540N  
- primeren za Schrack tip HSEMD02W2F  
- komunikacijski modul ni vgrajen

## ADAPTER NEXANS/SCHRACK 2M

- fixing adapter for Nexans LANmark and Schrack module 45x45mm  
- suitable for Nexans type N423.540N  
- suitable for Schrack type HSEMD02W2F  
- communication module not included

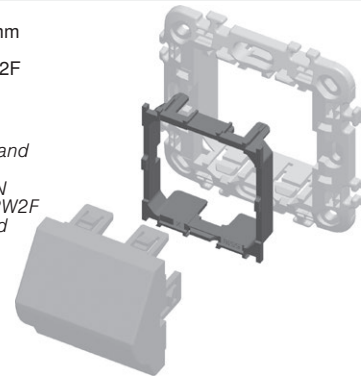

## ADAPTER AT&amp;T SYSTIMAX S PRAŠNO ZAŠČITO 1M



- KM48PW
- KM48MW
- KM48SB
- KM48AT
- KM48ES
- KM48IW

- AT&T Systimax pritrditveni standard s protiprašnim pokrovom  
- komunikacijski modul ni vgrajen

## ADAPTER AT&amp;T SYSTIMAX WITH DUST PROTECTION 1M

- AT&T Systimax fixing standard with dust protection  
- communication module not included



## VTIČNICA USB TIP A 1M



- KM51PW
- KM51MW
- KM51SB
- KM51AT
- KM51ES
- KM51IW

- USB 2.0 vtičnica tip A  
- vijačna pritrnitev vodnikov, raster 5 mm, 1,5 mm<sup>2</sup>, 1x2P + 1x3P  
- ožičenje:  
PIN 1 – VCC (+5V, rdeča žica)  
PIN 2 – signal - (bela žica)  
PIN 3 – signal + (zeleno žica)  
PIN 4 – GND - masa (črna žica)  
S – oklop  
- ustreza direktivi 2011/95/EU (RoHS2)

## SOCKET USB TYPE A 1M

- USB 2.0 socket type A  
- screw contacts, raster 5 mm, 1,5 mm<sup>2</sup>, 1x2P + 1x3P  
- wiring:  
PIN 1 – VCC (+5V, red wire)  
PIN 2 – Data - (white wire)  
PIN 3 – Data + (green wire)  
PIN 4 – GND - ground (black wire)  
S – shield  
- in accordance with directive 2011/95/EU (RoHS2)



1M = 22,5 x 45  
2M = 45 x 45

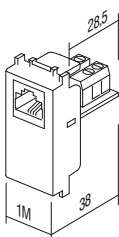

KM30

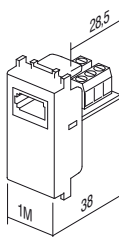

KM31

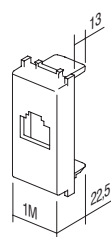
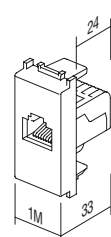
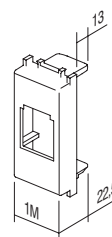
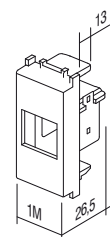
KM35  
KM38  
KM48KM36  
KM37  
KM39KM40  
KM43

KM45

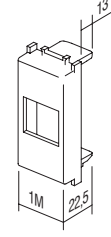
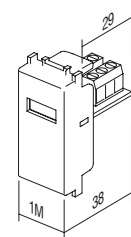
KM46  
KM47  
KM50  
KM52  
KM53

KM51

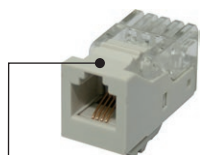

KA10

tip type	naziv description	tehnični opis technical data
KA10	KONEKTOR KS CAT3 CONNECTOR KS CAT3	RJ11 6/4
KA11	KONEKTOR KS CAT5e CONNECTOR KS CAT5e	RJ45 8/8
KA12	KONEKTOR KS CAT5eS CONNECTOR KS CAT5eS	RJ45 8/8
⋮	⋮	⋮



KONEKTOR KS CAT3 RJ11 6/4

---

KA10

- KS keystone pritrditveni standard
- CAT3, RJ11 6/4
- ustreza IEC 60603-7

*CONNECTOR KS CAT3 RJ11 6/4*

- KS keystone fixing standard
- CAT3, RJ11 6/4
- in accordance with IEC 60603-7



KONEKTOR KS CAT5e RJ45 8/8

---

KA11

- KS keystone pritrditveni standard
- CAT5e, RJ45 8/8
- ustreza IEC 60603-7

*CONNECTOR KS CAT5e RJ45 8/8*

- KS keystone fixing standard
- CAT5e, RJ45 8/8
- in accordance with IEC 60603-7



KONEKTOR KS CAT5eS RJ45 8/8

---

KA12

- KS keystone pritrditveni standard
- CAT5eS, RJ45 8/8
- ustreza IEC 60603-7

*CONNECTOR KS CAT5eS RJ45 8/8*

- KS keystone fixing standard
- CAT5eS, RJ45 8/8
- in accordance with IEC 60603-7



KA15

## KONEKTOR KS CAT6 SCH RJ45 8/8

- KS keystone pritrditveni standard
- CAT6 UTP toolless, RJ45 8/8
- ustreza ISO/IEC 11801

*CONNECTOR KS CAT6 SCH RJ45 8/8*

- KS keystone fixing standard
- CAT6 UTP toolless, RJ45 8/8
- in accordance with ISO/IEC 11801



KA16

## KONEKTOR KS CAT6S SCH RJ45 8/8

- KS keystone pritrditveni standard
- CAT6S STP toolless, RJ45 8/8
- ustreza ISO/IEC 11801

*CONNECTOR KS CAT6S SCH RJ45 8/8*

- KS keystone fixing standard
- CAT6S STP toolless, RJ45 8/8
- in accordance with ISO/IEC 11801

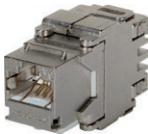

KA17

## KONEKTOR KS CAT6a SCH RJ45 8/8

- KS keystone pritrditveni standard
- CAT6a STP toolless, RJ45 8/8
- ustreza ISO/IEC 11801

*CONNECTOR KS CAT6a SCH RJ45 8/8*

- KS keystone fixing standard
- CAT6a STP toolless, RJ45 8/8
- in accordance with ISO/IEC 11801



KA18

## KONEKTOR SLIM KS CAT6S SCH RJ45 8/8

- KS keystone pritrditveni standard
- slim verzija
- CAT6S STP toolless, RJ45 8/8
- ustreza ISO/IEC 11801
- primeren tudi za dvojni adapter KE46

*CONNECTOR SLIM KS CAT6S SCH RJ45 8/8*

- KS keystone fixing standard
- slim style
- CAT6S STP toolless, RJ45 8/8
- in accordance with ISO/IEC 11801
- suitable also for KE46 double adapter



□ KA27PW  
 ■ KA27BK

## KONEKTOR KS HDMI

- KS keystone pritrditveni standard
- samo v kombinaciji z adapterjem KM50
- HDMI/HDMI

*CONNECTOR KS HDMI*

- KS keystone fixing standard
- only in combination with adapter KM50
- HDMI/HDMI



KA28

## KABEL KS HDMI

- KS keystone pritrditveni standard
- samo v kombinaciji z adapterjem KM50
- HDMI/HDMI

*CABLE KS HDMI*

- KS keystone fixing standard
- only in combination with adapter KM50
- HDMI/HDMI



EM33



PW



tip type	naziv description	tehnični opis technical data	velikost size	barva colour	
EM12	ZATEMNILNIK ROTACIJSKI MENJALNI DIMMER ROTATIVE 2WAY	RL 300W	1M	<input type="checkbox"/> PW bela-sijaj polar white	<input type="checkbox"/> BL modra blue
EM23	ZATEMNILNIK VGRADNI DIMMER INBOX	R (250 W), (RC,RL 200VA)	/	<input type="checkbox"/> MW bela-mat matte white	<input type="checkbox"/> RD rdeča red
.	.	.	.	<input type="checkbox"/> SB črna-mat soft touch black	<input type="checkbox"/> GR zelena green
.	.	.	.	<input type="checkbox"/> AT antracit anthracite	<input type="checkbox"/> OR oranžna orange
.	.	.	.	<input type="checkbox"/> ES srebrna elox silver	<input type="checkbox"/> RG rdeča/zelena red/green
.	.	.	.	<input type="checkbox"/> IW bež-sijaj ivory white	

ZATEMNILNIK ROTACIJSKI/MENJALNI RL 300 W 1M



- EM12PW
- EM12MW
- EM12SB
- EM12AT
- EM12ES
- EM12IW

- rotacijski z menjalnim stikalom
- breme RL, 40W - 300W
- napajanje 230V~ 50Hz
- možna vezava z menjalnim stikalom
- montaža več naprav skupaj v eno dozo dovoljena samo pod pogojem, da njihovo skupno maksimalno breme ne presega maksimalne moči enega zatemnilnika
- v istem tokokrogu je dovoljena uporaba samo enega zatemnilnega stikala
- varovalka ni vgrajena – potrebna vezava zunanje varovalke
- ustreza EN 60669-1
- vijačni kontakti - 1.5-2.5mm<sup>2</sup>
- vgrajena LED indikacija stopnje zatemnitve



DIMMER ROTATIVE/2WAY RL 300W 1M

- rotation control with 2-way switch
- load RL, 40W - 300W
- supply voltage 230V~ 50Hz
- 2-way switch combination is possible
- installing several devices together in one box is only permitted if their total maximum load does not exceed the maximum power of a single dimmer
- one circuit allows the use of only one dimmer
- no built-in fuse – external fuse must be used
- in accordance with EN 60669-1
- screw contacts - 1.5-2.5mm<sup>2</sup>
- integrated LED indication of dimming level

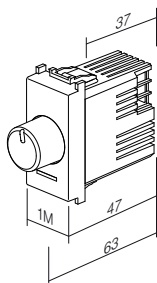

ZATEMNLNIK ROTACIJSKI/MENJALNI LED 60 W 1M



- EM13PW
- EM13MW
- EM13SB
- EM13AT
- EM13ES
- EM13IW

- rotacijski z menjalnim stikalom
- bremena: LED, 0 – 60 W (max. 6 LED zatemnilnih sijalk)  
GLS, 0 – 60 W
- napajanje 230V~ 50Hz
- možna vezava z menjalnim stikalom
- montaža več naprav skupaj v eno dozo dovoljena samo pod pogojem, da njihovo skupno maksimalno breme ne presega maksimalne moči enega zatemnilnika
- v istem tokokrogu je dovoljena uporaba samo enega zatemnilnega stikala
- varovalka ni vgrajena – potrebna vezava zunanje varovalke
- ustreza IEC60669-2-1
- vijačni kontakti - 1.5÷2.5mm<sup>2</sup>

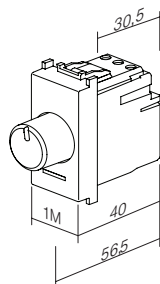

DIMMER ROTATIVE/2WAY LED 60W 1M

- rotation control with 2-way switch
- loads: LED, 0 – 60W (max. 6 dimmable LED lamps)  
GLS, 0 – 60W
- supply voltage 230V~ 50Hz
- 2-way switch combination is possible
- installing several devices together in one box is only permitted if their total maximum load does not exceed the maximum power of a single dimmer
- one circuit allows the use of only one dimmer
- no built-in fuse – external fuse must be used
- in accordance with IEC60669-2-1
- screw contacts - 1.5-2.5mm<sup>2</sup>

ZATEMNLNIK ROTACIJSKI/MENJALNI LED 180 W 1M



- EM14PW
- EM14MW
- EM14SB
- EM14AT
- EM14ES
- EM14IW

- rotacijski z menjalnim stikalom
- bremena:  
LED, 0 – 180 W (max. 20 LED zatemnilnih sijalk)  
GLS, 0 – 180 W
- napajanje 230V~ 50Hz
- možna vezava z menjalnim stikalom
- montaža več naprav skupaj v eno dozo dovoljena samo pod pogojem, da njihovo skupno maksimalno breme ne presega maksimalne moči enega zatemnilnika
- v istem tokokrogu je dovoljena uporaba samo enega zatemnilnega stikala
- varovalka ni vgrajena – potrebna vezava zunanje varovalke
- ustreza IEC60669-2-1
- vijačni kontakti - 1.5÷2.5mm<sup>2</sup>

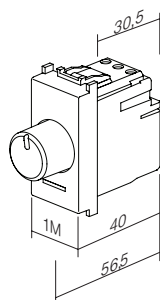

DIMMER ROTATIVE/2WAY LED 180W 1M

- rotation control with 2-way switch
- loads:  
LED, 0 – 180W (max. 20 dimmable LED lamps)  
GLS, 0 – 180W
- supply voltage 230V~ 50Hz
- 2-way switch combination is possible
- installing several devices together in one box is only permitted if their total maximum load does not exceed the maximum power of a single dimmer
- one circuit allows the use of only one dimmer
- no built-in fuse – external fuse must be used
- in accordance with IEC60669-2-1
- screw contacts - 1.5-2.5mm<sup>2</sup>

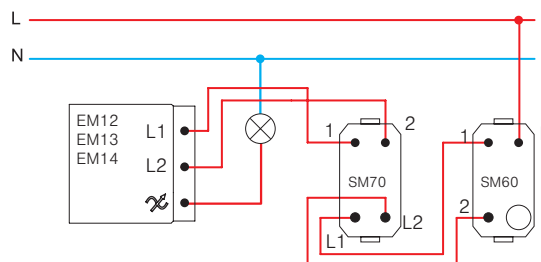
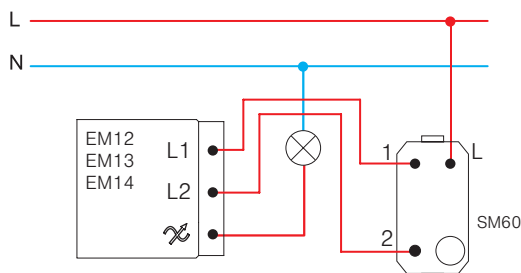
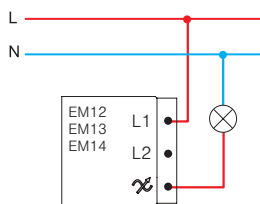

ZATEMNILNIK ROTACIJSKI R 250W 1M



- EM15PW
- EM15MW
- EM15SB
- EM15AT
- EM15ES
- EM15IW

- rotacijski brez stikala
- breme R, 40W - 250W
- napajanje 230V~ 50Hz
- vezava z menjalnim stikalom ni možna
- vezava več zatemnilnikov ni dovoljena
- ustreza EN 60669-1
- vijajčna pritrditev vodnikov 1.5-2.5 mm<sup>2</sup>
- LED indikacija



*DIMMER ROTATIVE R 250W 1M*

- rotation control without switch
- load R, 40W - 250W
- supply voltage 230V~ 50Hz
- 2-way switch combination is not possible
- more dimmers combination is not allowed
- in accordance with EN 60669-1
- screw contacts 1.5-2.5mm<sup>2</sup>
- LED indication

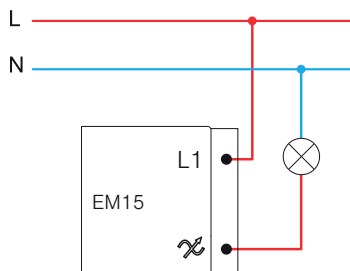
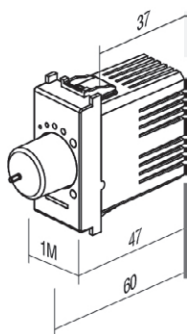

ZATEMNILNIK VGRADNI R (250 W), (RC,RL 200VA)



EM23



- vgradni, za vezavo s tipkalom
- breme RLC 15-250W ali 15-200 VA
- napajanje 230 V~ 50Hz
- možna vezava več tipkal
- vezava več zatemnilnikov ni dovoljena
- vgrajena spominska funkcija
- funkcija mehkega vklopa/izklopa
- »leading edge«
- ustreza EN60669, EN60950, EN 61000, ETSI EN 300 220-1, ETSI EN 300 220-2
- vijajčna pritrditev vodnikov do preseka 2,5mm<sup>2</sup>

*DIMMER INBOX R (250 W), (RC, RL 200 VA)*

- inbox, controlled by external push button
- load RLC 15-250W or 15-200 VA
- supply voltage 230V~ 50Hz
- several push-buttons combinations are possible
- more dimmers combination is not allowed
- light intensity memory
- soft start/stop function
- »leading edge«
- in accordance with EN60669, EN60950, EN 61000, ETSI EN 300 220-1, ETSI EN 300 220-2
- screw contacts to wires 2,5 mm<sup>2</sup>

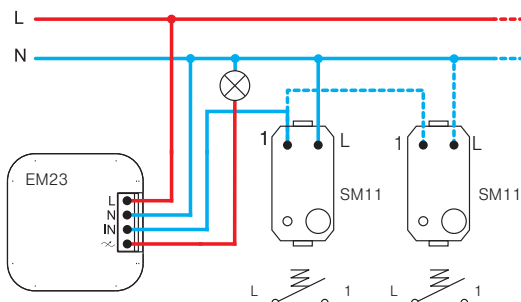
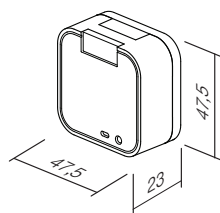





- EM16PW
- EM16MW
- EM16SB
- EM16AT
- EM16ES
- EM16IW



### 1-10 V ZATEMNILNIK ROTACIJSKI MENJALNI

- nominalna delovna napetost: 10VDC
- minimalna delovna napetost: 0,7VDC
- območje zatemnjevanja: 0,7% - 100% (odvisno od napajalnika in bremen)
- minimalni ponorni tok: 0,1mA
- maksimalni ponorni tok: 120mA
- maksimalna poraba: 0,35W
- prenapetostna zaščita: 15,8VDC do 250mA (nezamenljiva)
- največji pulzni tok: 3ADC
- vrsta bremen: 0-10V, 1-10V in PWM
- tip stikala: mehanski: potisni vklop/izklop
- ničelni vodnik: ni potreben
- nominalna delovna napetost: 100-240 V~, 50-60 Hz
- maksimalni trenutni tok: 10A
- maksimalni delovni tok: 8A
- maksimalna obremenitev (pri 230 V~): 1800VA (1800 x pf = max. W)
- izolacijska upornost: > 100MΩ pri 250 V~
- prenapetostna in kratkostična zaščita: 10A, 350V~ (nezamenljiva)
- rotacijski kot: 270° ± 5°
- temperatura delovanja: -5 do 40°C
- temperatura skladiščenja: -30 do 80 °C
- maksimalna temperatura ohišja: 65°C
- maksimalna vlažnost: 90% (brez kondenzacije)
- EMC in imunost: CISPR 15(2008), IEC 61547
- LVD: IEC 60669-1:2017, IEC 60669-2-1:2015

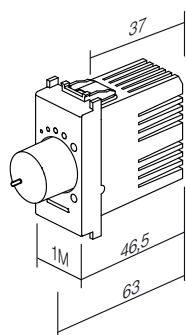
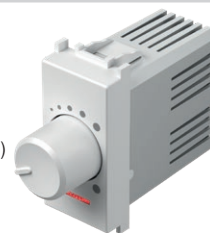

### 1-10 V DIMMER ROTARY TOGGLE

- nominal operating voltage: 10 VDC
- minimum operating voltage: 0.7 VDC
- dimming range: 0.7% – 100% (depending on power supply and loads)
- minimum sink current: 0.1 mA
- maximum sink current: 120 mA
- maximum consumption: 0.35 W
- surge protection: 15.8 VDC up to 250 mA (not replaceable)
- maximum pulse current: 3 ADC
- load types: 0-10 V, 1-10 V and PWM
- switch type: mechanical: push on/off
- zero cable: not required
- nominal operating voltage: 100-240 V~, 50-60 Hz
- maximum instantaneous current: 10 A
- maximum operating current: 8 A
- maximum load (at 230 V~): 1800 VA (1800 x pf = max. W)
- isolation resistance: > 100 MΩ at 250 V~
- surge protection and Short-circuit protection: 10 A, 350 V~ (not replaceable)
- rotation angle: 270° ± 5°
- operating temperature: -5 to 40°C
- storing temperature: -30 to 80°C
- maximum housing temperature: 65°C
- maximum humidity: 90% (no condensation)
- EMC & immunity: CISPR 15(2008), IEC 61547
- LVD: IEC 60669-1:2017, IEC 60669-2-1:2015

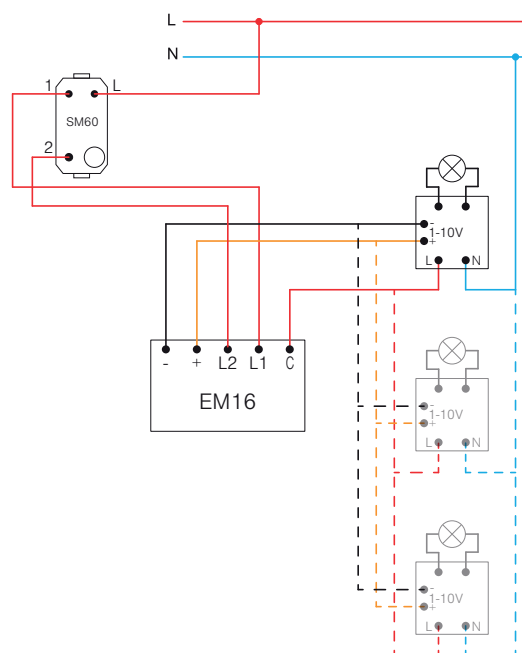
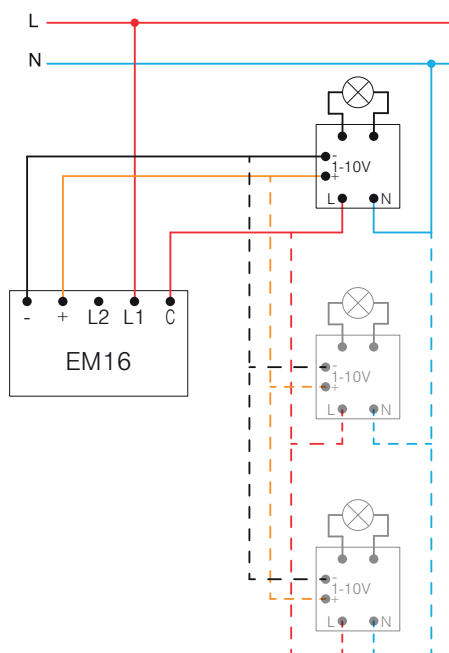

KRMILNI modul MZC za EM18

EM17

- MZC priklopite po vezalni shemi.
- možna vezava z več tipkali
- montaža samo ene naprave v eno dozo
- samo za notranjo uporabo
- napajanje: 230 V~ 50Hz
- maksimalna upornost žic: 50 kΩ
- maksimalen tok na enoto MZC: 10 mA
- število zatemnilnikov na MZC: 1-4
- maksimalno število MZC v vezavi: omejeno na varovalko v tokokrogu
- temperatura delovanja: -5 °C do 45 °C
- temperatura skladiščenja: -30 °C do 80 °C
- maksimalna vlažnost: 90 % (brez kondenziranja)
- dimenzije ohišja: 36 x 36 x 12 mm

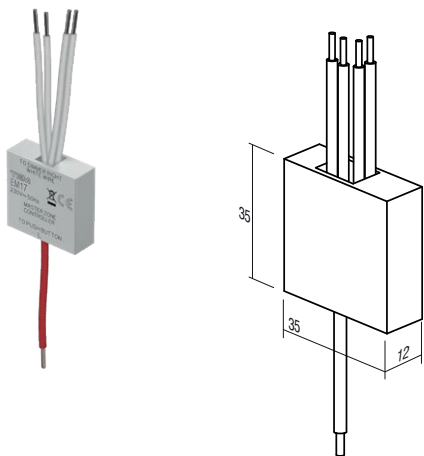

MZC CONTROL Module for EM18

- Connect the MZC according to the wiring diagram.
- Possible wiring with several push buttons.
- Only one device installation per mounting box.
- For indoor use only.
- Power supply: 230V~ 50Hz
- Max. cable resistance: 50kΩ
- Max. current per MZC unit: 10mA
- Number of dimmers on MZC: 1-4
- Max. number of MZC in the wiring: limited to the fuse in the circuit
- Operating temperature: -5°C to 45°C
- Storage temperature: -30°C to 80°C
- Max. humidity: 90% (no condensation)
- Casing dimensions: 36x36x12 mm

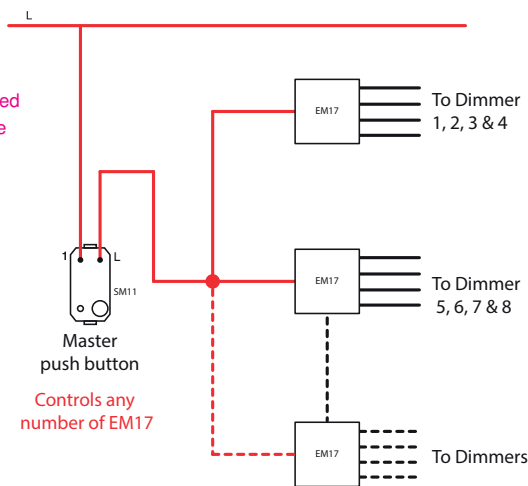
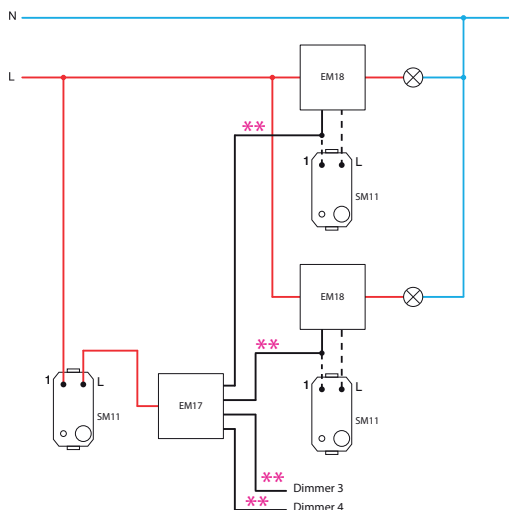

ZATEMNILNIK VGRADNI LED 250W

EM18

- vgradni, za vezavo s tipkalom
- za leading ali trailing edge
- napajanje 230 V~ 50 Hz
- možna vezava z več tipkali
- funkcija pomnjenja zadnje nastavitve, razen v primeru izpada napetosti
- funkcija mehkega vklopa/izklopa
- nastavev minimalne svetilnosti
- montaža samo ene naprave v eno dozo
- samo za notranjo uporabo
- ustreza EN 60669-1 in EN 60669-2-1



DIMMER INBOX LED 250W

- inbox, controlled by external push button
- for leading or trailing edge
- supply voltage 230V~ 50Hz
- several push-buttons combinations is possible
- memory function of the last setting, except in the case of a power failure
- soft start / stop function
- minimum intensity control
- only one dimmer per wall box
- only for indoor usage
- in accordance with EN 60669-1 and EN 60669-2-1

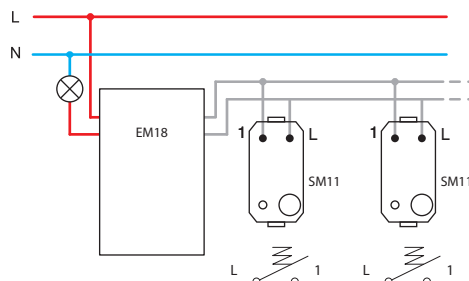
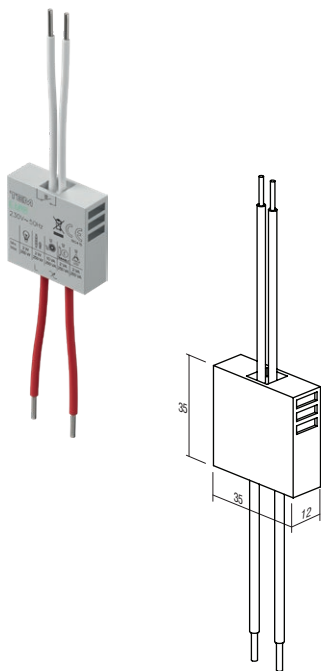

ZATEMNILNIK VGRADNI DC LED 96W

EM19

- vgradni, za vezavo s tipkalom
- vezava z vsemi LED napajalniki s konstantno napetostjo in nekaterimi LED napajalniki s konstantnim tokom, 9 – 48V DC, max 96W (tudi za LED trakove)
- ni za uporabo z induktivnimi bremen
- možna vezava z več tipkali in več zatemnilniki
- funkcija pomnjenja zadnje nastavitve, razen v primeru izpada napetosti
- funkcija mehkega vklopa / izklopa
- montaža samo ene naprave v eno dozo
- samo za notranjo uporabo

DIMMER INBOX DC LED 96W

- inbox, controlled by external push button
- for use with constant voltage LED drivers and some constant current LED drivers, 9-48V DC, max 96W (also for LED strips)
- not for use with inductive loads
- several push-buttons combinations and several dimmers is possible
- memory function of the last setting, except in the case of a power failure
- soft start / stop function
- only one dimmer per wall box
- only for indoor usage

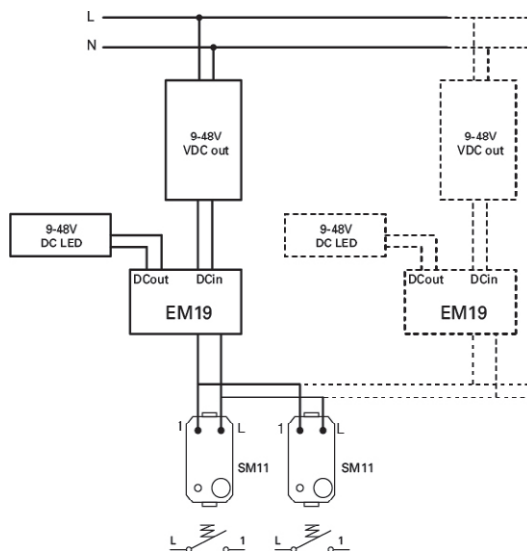
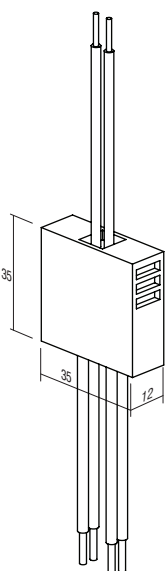

**POZOR!**

V primeru montaže več zatemnilnih stikal v isto dozo se za vsako dodatno zatemnilno stikalo zmanjša maksimalna skupna moč za 10%.

**ATTENTION!**

If more dimmers are connected in one box reduce maximum common power for 10% for each dimmer.

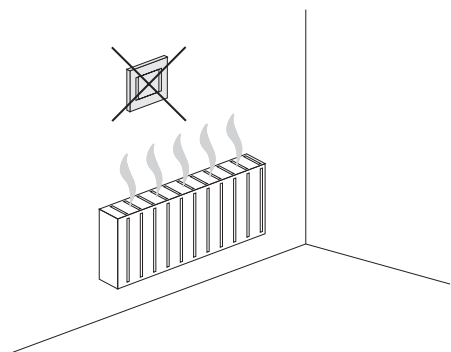

EM15 (40÷250W)

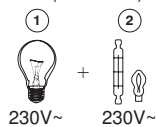

EM12 (40÷300W)

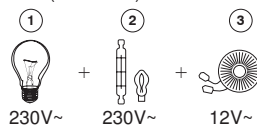

EM13 (0÷60W), EM14 (0÷180W), EM23 (15÷250W, 15÷200VA)

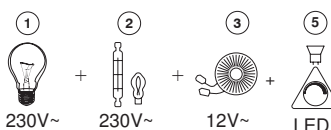

EM18 (2÷250VA)

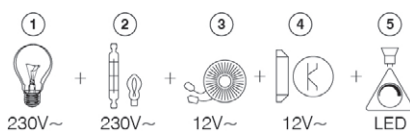

- 1 - žarnica z žarilno nitko / incandescent lamp
- 2 - halogenska žarnica / halogen lamp
- 3 - klasični transformator / classical transformer
- 4 - zatemnilni elektronski transformator / dimmable electronic transformer
- 5 - zatemnilna LED sijalka / dimmable LED lamp

STIKALO / ZATEMNILNIK UNIVERZALNI RLC 0-300W 2M



- EM25PW
- EM25MW
- EM25SB
- EM25AT
- EM25ES
- EM25IW



TOUCH EM25 je mikroprocesorsko voden elektronski zatemnilnik. Omogoča vklop, izklop in zatemnjevanje vseh zatemnilnih in nekaterih nezatemnilnih žarnic in sijalk. Vgrajeni mikroprocesor samodejno zazna vrsto sijalke in prilagodi režim delovanja. Ob izklopu si zapomni zadnjo nastavitve, saj ima vgrajeno spominsko funkcijo. Funkcija mehkega zagona podaljša življenjsko dobo sijalk. V tipko je vgrajena elegantna LED indikacija, z možnostjo izbire barve in nastavitve jakosti. Na EM25 lahko vezemo do 5 dodatnih upravljalnih tipkal EM26 (»slave«).

TOUCH EM25 is microprocessor controlled electronic light dimmer. It serves as switch and dimmer for dimmable and some of non-dimmable lamps. Integrated microprocessor automatically identifies the type of lamp and adjusts the operating mode. It remembers the level of dimming after switching off due to integrated memory function. Soft-start function extends the lamp service life. An elegant LED indication is integrated into the button and the option of choosing a colour and intensity level is provided. Optionally one can connect of up to 5 additional control tasters EM26 (»slave«).

- univerzalni elektronski zatemnilnik za vklop, izklop in zatemnjevanje vseh zatemnilnih žarnic in sijalk (klasične, halogenske, LED, CFL, ...)
- in nekaterih nezatemnilnih sijalk
- samodejno zazna vrsto sijalke in temu prilagodi režim delovanja
- z zatemnjevanjem se zmanjša poraba električne energije
- funkcija mehkega zagona podaljša življenjsko dobo sijalk
- upravljanje preko vgrajenih mikro-stikal
- vgrajena spominska funkcija - ob izklopu si zapomni nivo zatemnitve
- možna vezava do pet (5) dodatnih upravljalnih tipkal EM26
- vezava z menjalnimi stikali ni možna
- vgrajene zaščite pred kratkim stikom, pregrevanjem in preobremenitvijo
- napajanje 230V~ 50Hz
- vgrajena elegantna LED indikacija, z možnostjo nastavitve barve in jakosti
- omogoča zamenjavo klasičnega stikala – dvožična vezava<sup>(1)</sup>
- s trožično vezavo dosežemo polno funkcionalnost zatemnilnika<sup>(2)</sup>
- ustreza EN 60669-1 in EN 60669-2-1
- vijajna pritrditev vodnikov 1.5mm<sup>2</sup> (maks. moment privitja vijakov 0,4 Nm)

SWITCH / DIMMER UNIVERSAL RLC 0-300W 2M

- universal electronic dimmer for ON/OFF switching and dimming of all dimmable lamps (classical, halogen, LED, CFL, ...) and some non-dimmable lamps
- automatic detection of lamp type and adjustment of operating mode
- reduction of energy consumption
- soft start function extends life of lamps
- controlled by build-in micro switches
- memory function included – memorizes brightness on turn-off
- up to five (5) additional control units EM26 can be connected
- connection with 2-way switch is not possible
- build-in short-circuit, overheating and overload protection
- supply voltage 230V~ 50Hz
- an elegant integrated LED indication with the option of setting colour and intensity.
- replacement of classical switch is possible at two-wire connection<sup>(1)</sup>
- full functionality is achieved at three-wire connection<sup>(2)</sup>
- in accordance with EN 60669-1 and EN 60669-2-1
- screw contacts 1.5mm<sup>2</sup> (max. tightening torque 0.4Nm)

<sup>(1)</sup>dvožična vezava  
two-wire connection

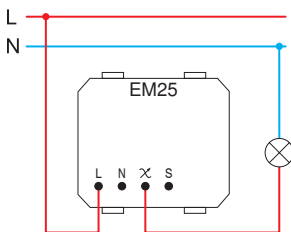

<sup>(2)</sup>trožična vezava  
three-wire connection

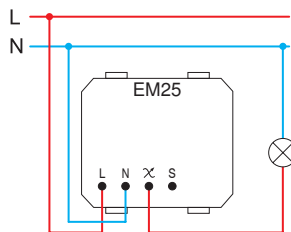

- dvožična vezava omogoča zatemnjevanje zatemnilnih žarnic in sijalk
- two-wire connection allows dimming of dimmable lamps

- trožična vezava omogoča zatemnjevanje zatemnilnih žarnic in sijalk in nekaterih nezatemnilnih LED in CFL sijalk
- three-wire connection allows dimming of dimmable lamps and some of non-dimmable LED and CFL lamps

	1	2	5	6	7
Min.	40 W	40 W	40 VA	40 VA	40 VA
Max.	300 W	300 W	300 VA	100 VA	100 VA
	(F)	(F)	(F)		

	1	2	4	6	7	8	9
Min.	0 W	0 W	0 VA	0 VA	0 VA	0 VA	0 VA
Max.	300 W	300 W	120 VA	120 VA	120 VA	120 VA	120 VA
	(F)	(F)	(F)			(F)	(F)

- 1 - žarnica z žarilno nitko / incandescent lamp
- 2 - halogenska žarnica / halogen lamp

- 4 - zatemnilni elektronski transformator / dimmable electronic transformer
- 5 - klasični transformator / classical transformer

- 6 - zatemnilna varčna CFL sijalka / dimmable energy saving CFL lamp
- 7 - zatemnilna LED sijalka / dimmable LED lamp

- 8 - nezatemnilna varčna CFL sijalka / non-dimmable energy saving CFL lamp
- 9 - nezatemnilna LED sijalka / non-dimmable LED lamp

opombe / remarks

- (F) filter EM27
- priporočamo uporabo filtra EM27 / it is recommended to use filter EM27
- vse krmiljene žarnice in sijalke morajo biti enake / all controlled lamps must be the same
- tabela bremen velja za sijalke s faktorjem PF>0.5 / table of loads is valid for lamps with power factor PF>0.5

vklop in izklop ter zatemnjevanje luči /  
on / off swithcing and dimming of lamp

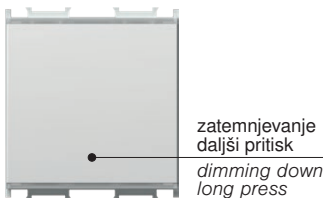
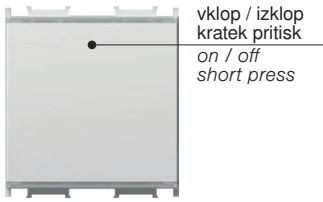

izbira barve in nastavev jakosti LED enote /  
LED unit colour and intensity level selection

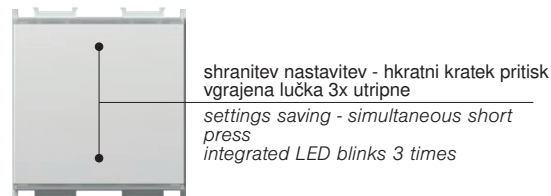
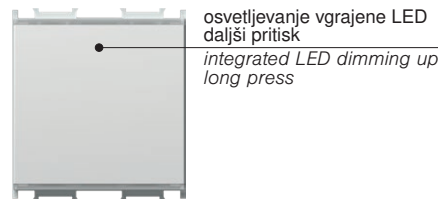
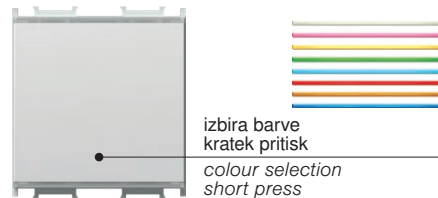
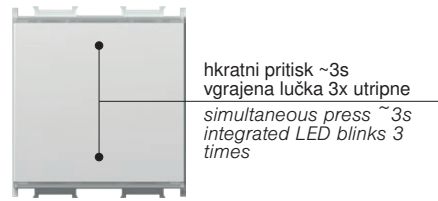
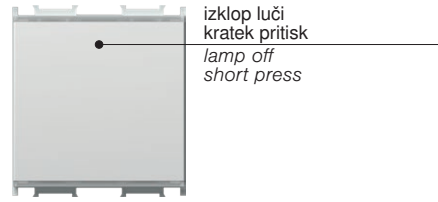

\*funkcija "RESET" /  
"RESET" function

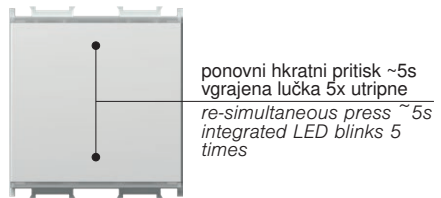
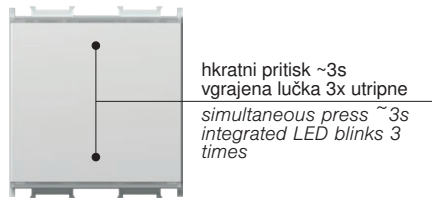
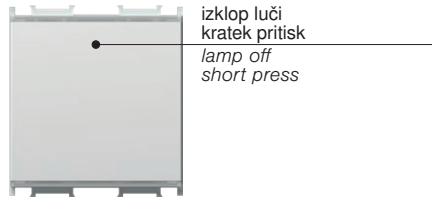

- \* - priporočamo ob vgraditvi zatemnilnika in menjavi žarnik ali sijalk
- obvezno ob uporabi nezatemnilnih sijalk
- funkcija "RESET" pri uporabi dvožične vezave ne deluje
- možno samo pri EM25
- it is recommended at dimmer installation and lamp replacement
- mandatory when using non-dimmable lamps
- "RESET" function is not possible when using two-wire connection
- only possible on EM25

opozorila za vgradnjo /  
installation precautions

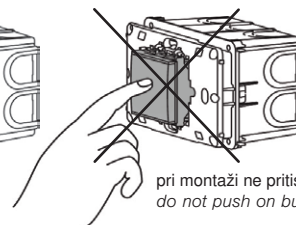
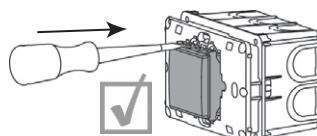
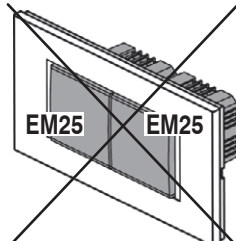
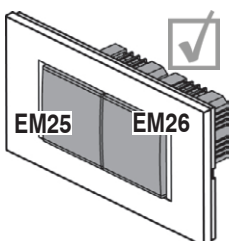

TIPKALO UPRAVLJALNO 2M

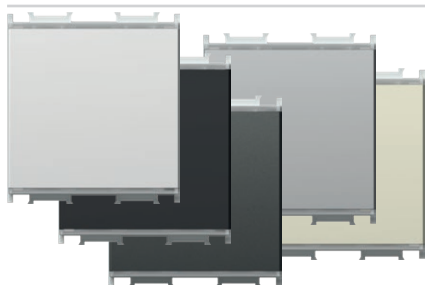

- EM26PW
- EM26MW
- EM26SB
- EM26AT
- EM26ES
- EM26IW

- v povezavi z univerzalnim zatemnilnikom EM25 omogoča upravljanje luči z več (do pet) lokacij z enako funkcionalnostjo kot EM25
- napajanje 230V~ 50Hz
- ustreza EN 60669-1 in EN 60669-2-1
- vijačna pritrditev vodnikov 1.5mm<sup>2</sup> (maks. moment privitja vijakov 0,4 Nm)

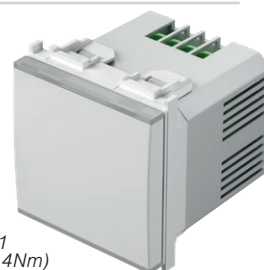

PUSH-BUTTON CONTROL UNIT 2M

- connected to universal dimmer EM25 allows controlling of lamps with same functionality as EM25
- supply voltage 230V~ 50Hz
- in accordance with EN 60669-1 and EN 60669-2-1
- screw contacts 1.5mm<sup>2</sup> (max. tightening torque 0.4Nm)

(1) dvožična vezava  
two-wire connection

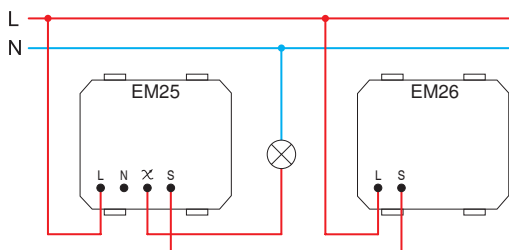

- dvožična vezava omogoča zatemnjevanje zatemnilnih žarnic in sijalk
- pri dvožični vezavi uporaba vsakega dodatnega upravljalnega tipkala poveča minimalno moč bremena za 25W
- two-wire connection allows dimming of dimmable lamps
- in a two-wire connection each additional control unit increases the minimum load by 25W

(2) trožična vezava  
three-wire connection

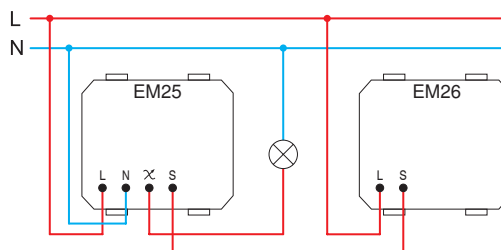

- trožična vezava omogoča zatemnjevanje zatemnilnih žarnic in sijalk in nekaterih nezatemnilnih LED in CFL sijalk
- three-wire connection allows dimming of dimmable lamps and some of non-dimmable LED and CFL lamps

SET STIKALO / ZATEMNILNIK UNIVERZALNI RLC 0-300W 2M PP OL20

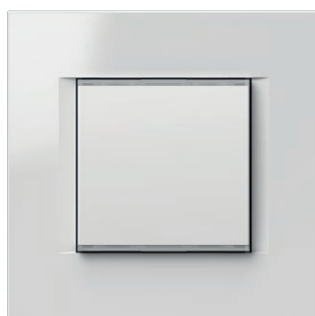

- EM25PPOL20

- set vsebuje zatemnilnik EM25, nosilec 2M in okvir LINE 2M PW
- za tehnični opis glej EM25

SET SWITCH / DIMMER UNIVERSAL RLC 0-300W 2M PP OL20

- set includes dimmer EM25, mounting frame 2M and cover plate LINE 2M PW
- for technical details see EM25



2M = 45 x 45

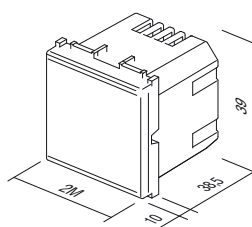

EM25  
EM26



EM27

## FILTER OMREŽNIH MOTENJ

- filter frekvenčnih motenj za EM25
- slika je simbolična

## FREQUENCY FILTER

- frequency filter for EM25
- image is symbolic

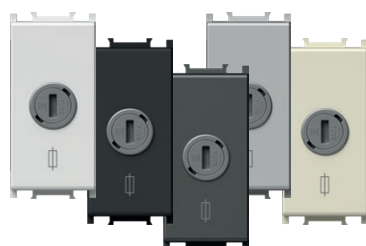
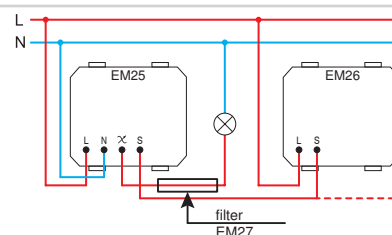

- EM28PW
- EM28MW
- EM28SB
- EM28AT
- EM28ES
- EM28IW

## OHIŠJE TALILNE VAROVALKE 230 V~, 50Hz 1M

- Napajanje: 230 V~, 50Hz
- Varovalka: MAX 10 A / 230 V~, 50Hz (varovalka ni priložena)
- Presek žic: 0,75 – 2,5mm<sup>2</sup>
- Temperatura delovanja: 0 do +40 °C
- Temperatura skladiščenja: -5 do +60 °C
- Število priključkov: 2; 1x L, 1x Izhod (L')
- Ustreza standardu: EN 60669-2-1:2004 + A1:2009 + A12:2010 EN 60669-1:2018



## MELT FUSE HOUSING 230 V~, 50 Hz 1M

- Supply voltage: 230 V~, 50 Hz (fuse not included)
- Fuse: MAX 10 A / 230 V~, 50Hz
- Wire cross-section: 0.75 - 2.5mm<sup>2</sup>
- Operating temperature: 0 to +40°C
- Storage temperature: -5 to +60°C
- Number of connectors: 2; 1x L, 1x Output (L')
- Corresponds to the standard: EN 60669-2-1:2004 + A1:2009 + A12:2010 EN 60669-1:2018

## VAROVALKA

EM29

- T5AH 250V, 5x20mm
- pakirano po 10kos



## FUSE T5AH

- T5AH 250V, 5x20mm
- packed in packs of 10 pcs

## IR STIKALO 5A 230V~ 1M



- EM31PW
- EM31MW
- EM31SB
- EM31AT
- EM31ES
- EM31IW

- IR infrardeče stikalo
- napajanje: 230V~ ±10 % 50Hz
- rele: 5A / 250V~ (zero crossing)
- stopnja varnosti: IP40
- presek žic pri stičniku: 0,75 - 2,5 mm<sup>2</sup>
- kot zaznavanja: do 110° pri 20°C
- območje zaznavanja: približno 8 m pri 20°C
- nastavljenost časovnega trajanja: od približno 5 s do 12 min
- nastavljenost osvetlitve: od približno 5 do 200 LUX
- temperatura delovanja: od 0°C do +40°C
- ni primeren za vgradnjo v doze, globine 45 mm in ohišja CUBO IP20
- samo za notranjo uporabo



## IR SWITCH 5A 230V~ 1M

- IR infrared switch
- supply voltage: 230V~, ±10 % 50Hz
- relay: 5A / 250V~ (zero crossing)
- protection rating: IP40
- cross-section of wires at the contact terminal: 0.75 - 2.5 mm<sup>2</sup>
- detection angle: up to 110° at 20°C
- detection area: approx. 8 m at 20°C
- adjustability of duration: from approx. 5 s to 12 min
- adjustability of brightness: from approx. 5 to 200 LUX
- operating temperature: from 0°C to +40°C
- not suitable for installation in 45 mm deep boxes and surface mount box CUBO IP20
- only for indoor usage

IR STIKALO 5A 230V~ 2M

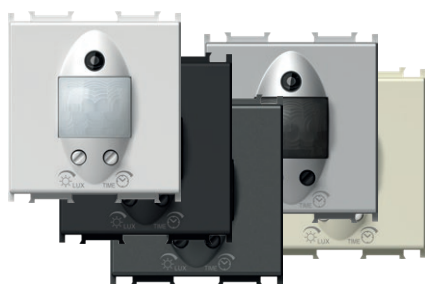

- EM32PW
- EM32MW
- EM32SB
- EM32AT
- EM32ES
- EM32IW



- IR infrardeče stikalo
- napajanje: 230V~ ±10 % 50Hz
- rele: 5A / 250V~ (zero crossing)
- stopnja varnosti: IP40
- presek žic pri stičniku: 0,75 - 2,5 mm<sup>2</sup>
- kot zaznavanja: do 110° pri 20°C
- območje zaznavanja: približno 8 m pri 20°C
- nastavljivost časovnega trajanja: od približno 5 s do 12 min
- nastavljivost osvetlitve: od približno 5 do 200 LUX
- temperatura delovanja: od 0°C do +40°C
- ni primeren za vgradnjo v doze, globine 45 mm
- in ohišja CUBO IP20
- samo za notranjo uporabo



IR SWITCH 5A 230V~ 2M

- IR infrared switch
- supply voltage: 230V~, ±10 % 50Hz
- relay: 5A / 250V~, (zero crossing)
- protection rating: IP40
- cross-section of wires at the contact terminal: 0.75 - 2.5 mm<sup>2</sup>
- detection angle: up to 110° at 20°C
- detection area: approx. 8 m at 20°C
- adjustability of duration: from approx. 5 s to 12 min
- adjustability of brightness: from approx. 5 to 200 LUX
- operating temperature: from 0°C to +40°C
- not suitable for installation in 45 mm deep boxes and surface mount box CUBO IP20
- only for indoor usage



SENZORSKO STIKALO 5A 230V~ 1M



- EM33PW
- EM33MW
- EM33SB
- EM33AT
- EM33ES
- EM33IW



- Napajalna napetost: 230 V~, 50Hz
- Izhod: Rele 5 A / 230 V~, 50Hz
- Presek žic: 0,75 - 2,5mm<sup>2</sup>
- Temperatura delovanja: 0 do +40 °C
- Temperatura skladiščenja: -5 do +60 °C
- Funkcije: nočno stikalo, stikalo z detekcijo premikanja, stikalo z detekcijo prisotnosti
- Indikacija programa: Oznaka na sprednjem pokrovu
- Število tipk/kontrol: 3
- Vrsta delovanja tipk/kontrol: Rotacija
- Nastavljivost časa vklopa izhoda: Od približno 10 s do 12 minut
- Območje zaznavanja: Približno 8 m
- Kot zaznavanja: Do 110°
- Nastavljivost osvetlitve: Od ~5 do ~200 lux
- Število priključkov: 4; 1x N, 1x L, 1x Izhod (L'), 1x Krmiljen vhod (S)
- Možnost krmiljenega vhoda: Da. Priključitev signala omrežne napetosti (230 V~) na sponko S.
- Dodatno: »Zero Crossing« (preklop stikala ob prehodu napetosti skozi 0 V)
- Poraba v stanju OFF / ON: 0.3 W / 0.6 W
- Ustreza standardu: EN 60669-2-1:2004 + A1:2009 + A12:2010 EN 60669-1:2018



SENSOR SWITCH 5A 230V~ 1M

- Supply voltage: 230 V~, 50Hz
- Output: Relay 5 A / 230 V~, 50 Hz
- Wire cross section: 0.75 - 2.5 mm<sup>2</sup>
- Operating temperature: 0 to + 40 °C
- Storage temperature: -5 to + 60 °C
- Functions: Night switch, Motion detection switch, Presence Detection Switch
- Programme indication: Mark on front cover
- Number of keys/controls: 3
- Operation Type of Key/Control: Rotation
- Adjusting the output activation time: From approx. 10 sec to 12 minutes
- Detection Area: Approximately 8 m
- Detection angle: Up to 110°
- Illumination adjustment: From ~5 to ~200 lux
- Number of connectors: 4; 1x N, 1x L, 1x Output (L'), 1x Controlled input (S)
- Controlled input option: Yes. Connection of the main voltage signal (230 V~) to terminal S.
- Optional: "Zero Crossing" (switching the switch when the voltage passes through 0 V)
- Power consumption in the OFF/ON state Corresponds to the standard: 0.3 W / 0.6 W
- EN 60669-2-1:2004 + A1:2009 + A12:2010 EN 60669-1:2018

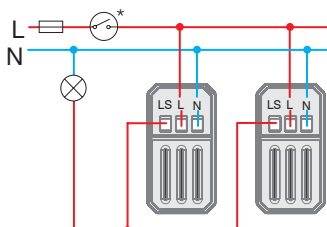

EM31 / EM32

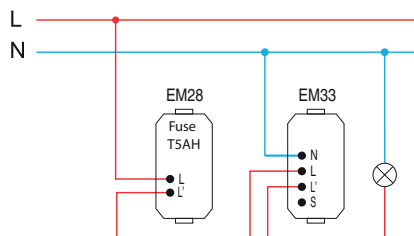

EM33

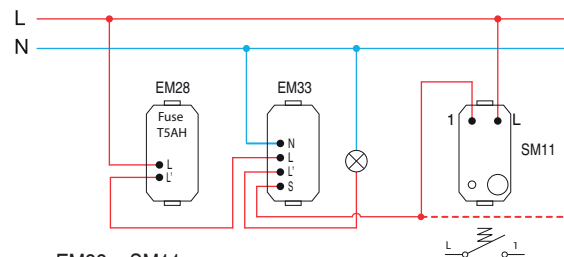

EM33 + SM11



## EM31 / EM32

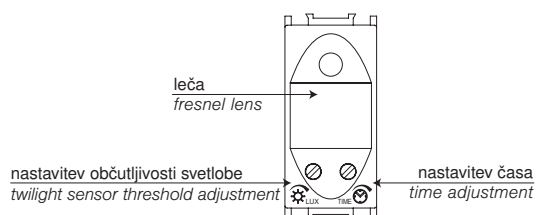

## EM33

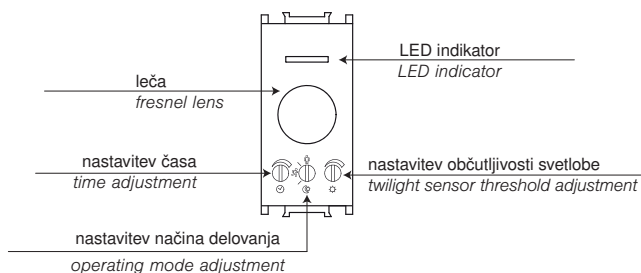

nastavitev občutljivosti in časa osvetlitve /  
time and twilight adjustment

	EM31 / EM32	EM33	EM31 / EM32	EM33
	~ 5 LUX	~ 5 LUX	~ 200 LUX	~ 200 LUX
	~ 5 s	~ 10 s	~ 12 min	~ 12 min

načini delovanja EM33  
EM33 operating mode

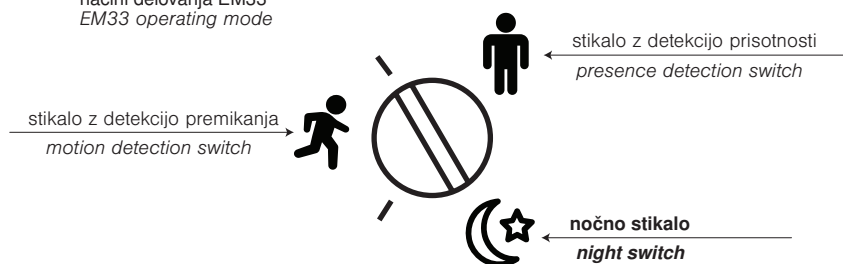

vrste bremen /  
types of load

		1	2	3	4	5	6	7	8	9	10
EM31 EM32 EM33	min.	1 W	1 W	—	1 VA	—	—	1 W	1 W	1 VA	1 VA
EM31 EM32	max.	800 W	800 W	5 A	6x20 VA	—	—	6x36 W	4x36 W	6x23 VA	6x20 VA
EM33	max.	1000 W	1000 W	5 A	650 VA	650 VA	2 A	—	—	100 VA	100 VA

- 1 - žarnica z žarilno nitko /  
incandescent lamp
- 2 - halogenska žarnica /  
halogen lamp
- 9 - varčna CFL sijalka /  
energy saving CFL lamp

- 3 - uporovno grelna telo /  
resistive heating element
- 4 - elektronski transformator /  
electronic transformer
- 10 - LED sijalka /  
LED lamp

- 5 - klasični transformator /  
classical transformer
- 6 - motor /  
motor

- 7 - fluorescentna cev (izvedba 1) /  
fluorescent tube (version 1)
- 8 - fluorescentna cev (izvedba 2) /  
fluorescent tube (version 2)

območje zaznavanja /  
detection range

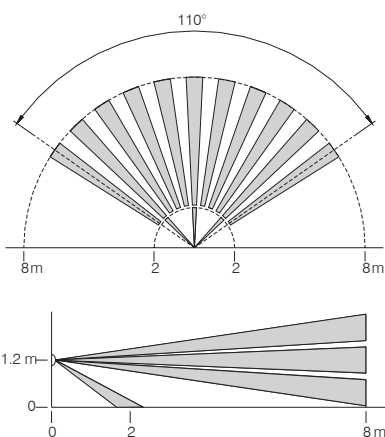

opozorila /  
attention

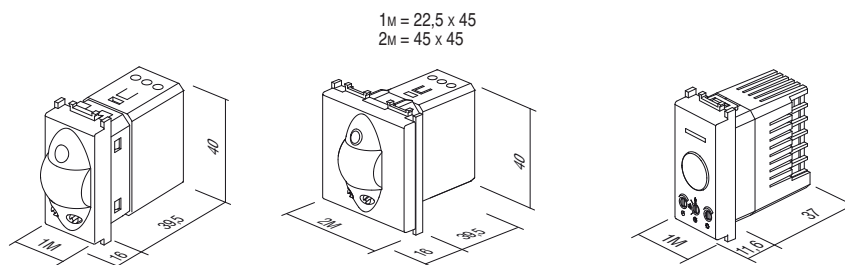
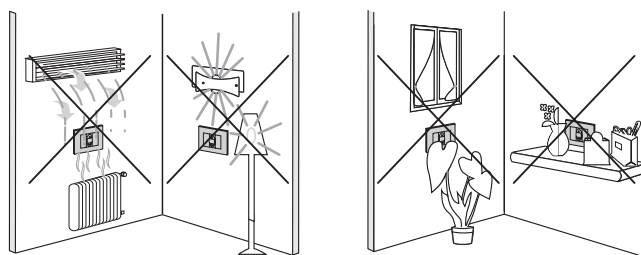

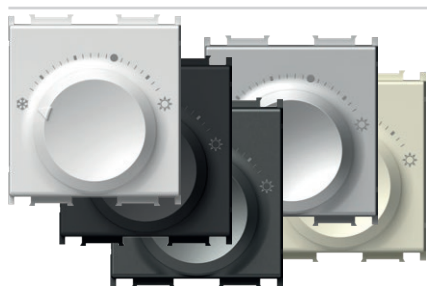

- EM38PW
- EM38MW
- EM38SB
- EM38AT
- EM38ES
- EM38IW

**TERMOSTAT OGREVANJE 5(2)A 230V~ 2M**

- način delovanja: ogrevanje
- napajanje: 230 V~, 50 Hz
- napetostni pulz: 4 kV
- poraba energije: < 0,5 W
- izhod: 2 A (max. 5 A); 230 V~, 50 Hz
- izhodni priključek: NO (max. 10 aktuatorjev)
- območje regulacije: +5 °C do +30 °C
- zaščita proti zmrzovanju: +5 °C
- histereza: 0,5 K
- zaščita: IP30
- vrsta tipala: bimetal
- vrsta električnega priključka: vzmetni kontakti
- vrsta vodnikov: 0,75 - 1,5mm<sup>2</sup> (mehkožilni); 1,0 - 2,5 mm<sup>2</sup> (trdožilni)
- skladno z direktivo DIN EN 60730



*HEATING THERMOSTAT 5(2)A 230V~ 2M*

- operation mode: heating
- power supply: 230 V~, 50 Hz
- voltage pulse: 4 kV
- energy consumption: < 0.5 W
- output: 2 A (max. 5 A); 230 V~, 50 Hz
- switching output: NO (max. 10 actuators)
- regulation range: +5°C to +30°C
- frost protection: +5°C
- hysteresis: 0.5 K
- protection: IP30
- sensor type: Bimetal
- type of electrical connection: Spring-loaded contacts
- type of conductors: 0.75 – 1.5 mm<sup>2</sup> (flexible-stranded core); 1.0 – 2.5 mm<sup>2</sup> (solid core)
- in compliance with Directive DIN EN 60730

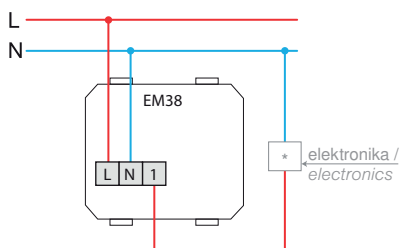

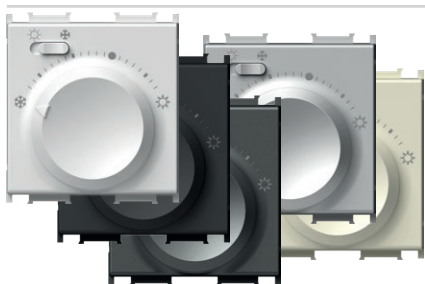

- EM39PW
- EM39MW
- EM39SB
- EM39AT
- EM39ES
- EM39IW

**TERMOSTAT OGREVANJE/HLAJENJE 3(1,5)A 230V~ 2M**

- način delovanja: ogrevanje/hlajenje
- napajanje: 230 V~, 50 Hz
- napetostni pulz: 4 kV
- poraba energije: < 0.5 W
- izhod: 1.5 A (max. 3 A); 230 V~, 50 Hz
- izhodni priključek:
  - preklopno stikalo (max. 5 aktuatorjev)
- območje regulacije: +5 °C do +30 °C
- zaščita proti zmrzovanju: +5 °C
- histereza: 0,5 K
- zaščita: IP30
- vrsta tipala: bimetal
- vrsta električnega priključka: vzmetni kontakti
- vrsta vodnikov:
  - 0,75 - 1,5mm<sup>2</sup> (mehkožilni);
  - 1,0 - 2,5 mm<sup>2</sup> (trdožilni)
- skladno z direktivo DIN EN 60730



**HEATING/COOLING THERMOSTAT 3(1.5)A 230V~ 2M**

- operation mode: cooling/heating
- power supply: 230 V~, 50 Hz
- voltage pulse: 4 kV
- energy consumption: < 0.5 W
- output: 1 A (max. 3 A); 230 V~, 50 Hz
- switching output: mode selector switch (max. 5 actuators)
- regulation range: +5°C to +30°C
- frost protection: +5°C
- hysteresis: 0,5 K
- protection: IP30
- sensor type: Bimetal
- type of electrical connection: Spring-loaded contacts
- type of conductors: 0.75 - 1.5mm<sup>2</sup> (flexible-stranded core); 1.0 - 2.5 mm<sup>2</sup> (solid core)
- in compliance with the Directive DIN EN 60730

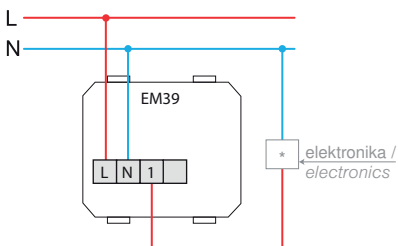

2M = 45 x 45

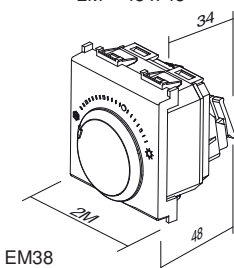

EM38

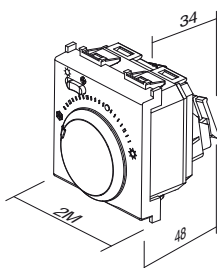

EM39

NOSILEC Z VIJAKI ZA TERMOSTATE FANTINI COSMI 3M

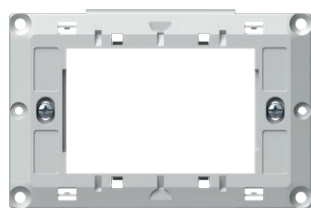

NM39

- nosilec z vijaki za termostate Fantini Cosmi 3M
- namenjen za uporabo z dnevnimi termostati Fantini Cosmi za modela CH121 in CH123
- namenjen za uporabo s tedenskimi termostati Fantini Cosmi za modela CH141A in CH143A
- montaža v pravokotne doze velikosti 3M
- primeren za sestavo z okvirji PURE, Line, Soft



MOUNTING FRAME WITH SCREWS FOR FANTINI COSMI THERMOSTATS 3M

- mounting frame with screws for Fantini Cosmi thermostats 3M
- suitable for use with Fantini Cosmi daily thermostats models CH121 and CH123
- suitable for use with Fantini Cosmi weekly thermostats models CH141A and CH143A
- for mounting in rectangular boxes 3M
- suitable for assembling with cover plates PURE, Line, Soft

KARTIČNO STIKALO 16 A / 230 V~, 50 Hz 3M



- EM46PW
- EM46MW
- EM46SB
- EM46AT
- EM46ES
- EM46IW

- Napajalna napetost: 230 V~, 50 Hz
- Izhod: Rele 16 A / 230 V~, 50 Hz
- Presek žic: 0,75 – 4,0 mm<sup>2</sup>
- Temperatura delovanja: 0 do +40 °C
- Temperatura skladiščenja: -5 do +60 °C
- Funkcija: Kartično stikalo z zakasnjnim izklopom
- Zakasnitev izklopa: ~23 s
- Število priključkov: 6; 2x N, 2x L in 2x izhod (C in NO)
- Poraba v stanju OFF / ON: 0.5 W / 1.2 W



CARD SWITCH 16 A / 230 V~, 50 Hz 3M

- Supply voltage: 230 V~, 50 Hz
- Output: Relay 16 A / 230 V~, 50 Hz
- Wire cross-section: 0.75 - 4.0 mm<sup>2</sup>
- Operating temperature: 0 to +40°C
- Storage temperature: -5 to +60°C
- Function: Card switch with a delayed break
- Break delay: ~23 s
- Number of ports: 6; 2x N, 2x L and 2x output (C and NO)
- Power consumption in the OFF/ON state: 0.5 W / 1.2 W

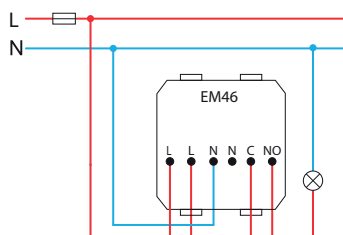
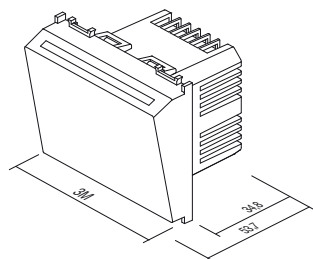



■ EM44BK

## KARTIČNO STIKALO ZA VARČEVANJE Z ENERGIJO RF HF 13,56MHz 3M

- kartično stikalo elektronsko na RFID ISO kartico
- napajanje iz rele enote EM49 preko kabla s konektorji RJ12
- izhod za povezavo z rele enoto EM49
- zakasnitev izklopa "main power" ob izvlečenju kartice 15-20 s
- zakasnitev izklopa "HVAC" ob izvlečenju kartice pri odprtih balkonskih vratih ali oknu - 1 min
- ustreza EN 61000-6-1
- kartica ni priložena
- ni namenjeno kontroli pristopa

*ENERGY SAVER CARD SWITCH RF HF 13,56MHz 3M*

- electronic card switch for RFID ISO card
- supply from relay unit EM49 through cable connectors RJ12
- output to be connected to relay output unit EM49
- 15-20s "main power" switch off delay with card withdrawal
- 1 min "HVAC" switch off delay with card withdrawal when balcony doors or windows opened
- in accordance with EN 61000-6-1
- card is not included
- not for access control

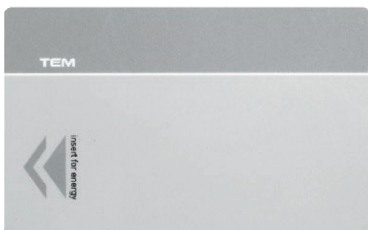
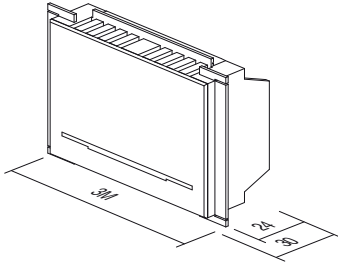

EM47

## KARTICA ISO

- ISO kartica
- za uporabo s kartičnim stikalom EM46
- velikost: 85x54 mm

*CARD ISO*

- ISO card
- for combination with card switch EM46
- size: 85x54 mm

RELE ENOTA ZA KARTIČNO STIKALO 2X16A 250V~

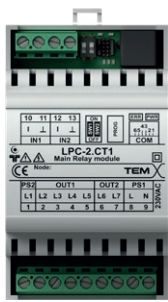

EM49

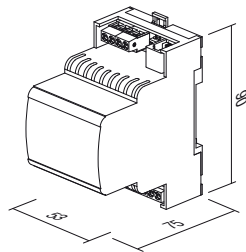

- rele enota za kartična stikala EM44
- napajanje 230V~ 50 Hz
- ustreza EN 61000-6-1
- montaža na DIN letev 35mm, 3MU
- vhodi in izhodi glede na vgradnjo: enosobno ali dvosobno

ENERGY SAVER CONTROL UNIT 2x16A 250V~

- relay unit for card switches EM44
- supply voltage 230V~ 50Hz
- in accordance with EN 61000-6-1
- mounting on DIN rail 35mm, 3MU
- input and output depending on implementation: single or double room



EM45

RAZDELILNIK SPL-1

- za povezavo dveh kartičnih stikal EM44 z rele enoto EM49
- komunikacijski konektor RJ12
- velikost: 37 x 30 x 27 mm

SPLITTER SPL-1

- used to connect two peripheral modules EM44 to relay unit EM49
- communication connector RJ12
- size: 37 x 30 x 27 mm

vezalna shema za enosobno delovanje /  
wiring diagram for single room implementation

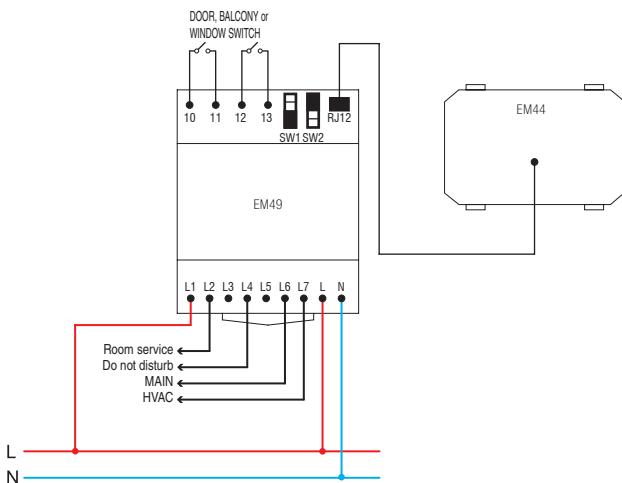

vezalna shema za dvosobno delovanje /  
wiring diagram for double room implementation

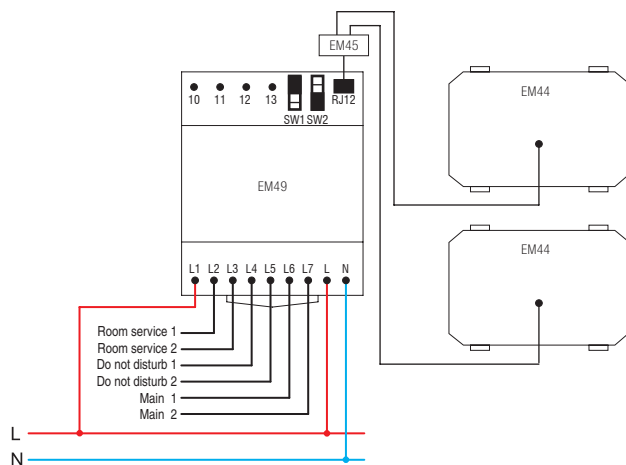

povezovalni kabel RJ12 med EM44 in EM49 /  
connection cable RJ12 between EM44 and EM49

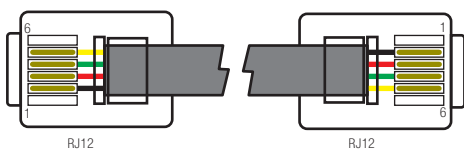

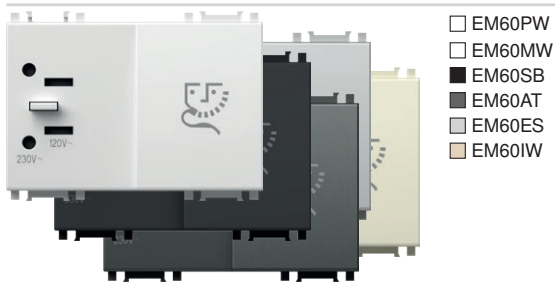

- EM60PW
- EM60MW
- EM60SB
- EM60AT
- EM60ES
- EM60IW

#### VTIČNICA ZA BRIVNIK 230V~/120V~ 3M

- vtičnica za brivnik z ločilnim transformatorjem 20VA
- vhod: 230V~ 50-60Hz
- izhod:
- 230V~ za 2P 2.5A EURO vtič ali
- 120V~ za 2P 15A ameriški vtič
- razred zaščite II
- ustreza EN 61558-2-5

#### SOCKET SHAVER 230V~/120V~ 3M

- shaver supply unit with isolating transformer 20VA
- supply: 230V~ 50-60Hz
- output:
- 230V~ for 2P 2.5A Europlug or
- 120V~ for 2P 15A American plug
- Class II
- in accordance with EN 61558-2-5

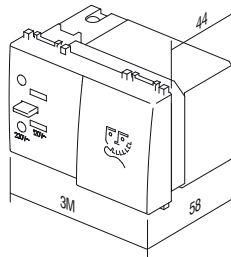
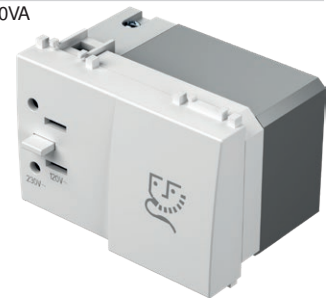

3M = 67,5 x 45

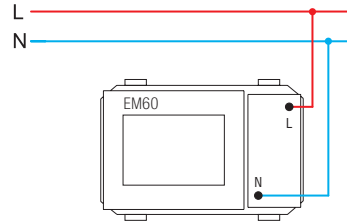

EM57

#### LED ZASILNA SVETILKA 230V~50Hz, 0.5W, NiMH 2h 2M

- zasilna LED svetilka
- možnost uporabe kot prenosne ročne svetilke (izvlečni mehanizem)
- napajanje 230V~ 50Hz 1xLED 0.5W
- NiMH akumulator 3,6V 140mAh, zamenljiv
- avtonomija 2 h, polnjenje 36 h
- varnostni razred naprave II
- ustreza EN60598-1, EN60598-2-2, EN62471, EN55015:2006, EN61547

#### LED EMERGENCY LIGHT 230V~50Hz, 0.5W, NiMH 2h 2M

- emergency LED lamp
- option to use it as a hand lamp (pull-out mechanism)
- supply voltage 230V~50Hz, 1xLED 0.5W
- NiMH accumulator 3,6V 140mAh, replaceable
- autonomy 2h, charging 36h
- class device II
- in accordance EN60598-1, EN60598-2-2, EN62471, EN55015:2006, EN61547

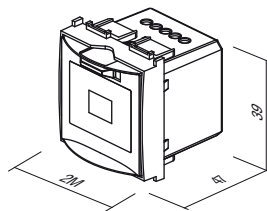
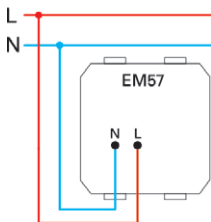
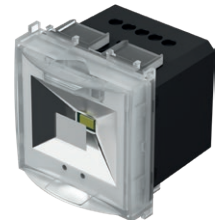



□ EM55

LED ZASILNA SVETILKA 250V~ 0.9W, NiCd 3h 7M

- zasilna LED svetilka
- napajanje 250V~ 50Hz 3xLED 0,3W, 10000mcd, 6500K
- NiCd akumulator 4,8V 400 mAh, zamenljiv
- avtonomija 3h, polnjenje 24h
- razred zaščite II
- ustreza EN 60598-1, EN 60598-2-2, EN 60598-2-22



LED EMERGENCY LIGHT 250V~ 0.90W, NiCd 3h 7M

- emergency LED lamp
- supply voltage 250V~ 50Hz 3x LED 0,3W, 10000mcd, 6500K
- NiCd accumulator 4,8V 400 mAh, replaceable
- autonomy 3h, charging 24h
- Class II
- in accordance with EN 60598-1, EN 60598-2-2, EN 60598-2-22

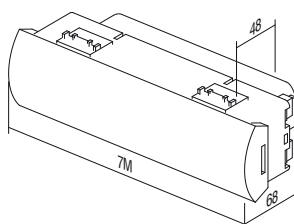

7M = 157 X 45

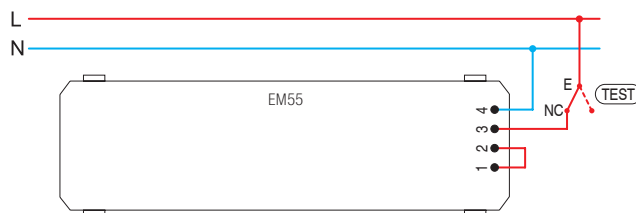





- EM69PW
- EM69MW
- EM69SB
- EM69AT
- EM69ES
- EM69IW

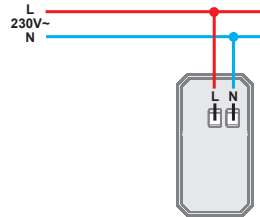
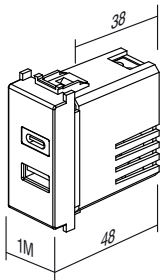

### POLNILNIK USB PD 20W

- USB napajalnik z dovajanjem moči do 20W.
- za polnjenje elektronskih naprav prek standardnega USB priključka (kompatibilno tudi z Apple napravami)
- napajanje: 100-230 V~ 50/60 Hz
- poraba med delovanjem: 420 mA pri 100 V~/220 mA pri 230 V~
- poraba v mirovanju: <100 mW pri 230 V~
- izhodna moč: 20W Max
- Izhod:
  - USB tip C: 5.0 VDC 3.0A; 9.0 VDC 2.2 A; 12.0 VDC 1.67 A (PD 20W)
  - USB tip A: 5.0 VDC 3.0A; 9.0 VDC 2.0 A; 12.0 VDC 1.5 A (QC 18W)
  - USB A+C: 5 VDC 3A
- tip konektorja: 1 x USB A; 1 x USB C
- povprečna učinkovitost v aktivnem stanju: 86 %
- učinkovitost pri minimalnem bremenu (10%): 81%
- temperatura delovanja: 0 °C/+ 45 °C (notranja uporaba)
- IP zaščitni razred: IP20, samo za notranjo uporabo
- varnostni razred naprave II
- prenapetostna zaščita (EN 60364-4-44): razred III
- vijajna pritrditev vodnikov max. 2.5 mm<sup>2</sup>
- naprava z odmikom kontaktov min. 3 mm
- ni primeren za vgradnjo v doze globine 45 mm in ohišja CUBO IP20
- Ustreza:
  - Direktivam: BT, EMC, RoHS, ErP
  - Standardim: EN IEC 62368-1, EN 55032, EN55035, EN IEC 61000-3-2, EN 61000-3-3, EN 50563, EN IEC 63000
  - Dodatnim regulativam: (EU) n. 2019/1782 REACH, n. 1907/2006 – art.33. Produkt lahko vsebuje sledi svinca.



### USB POWER SUPPLY UNIT PD 20W

- 20 W USB power delivery power supply unit
- for charging of electronic devices via a standard USB port (also compatible with Apple devices)
- power supply: 100-230V~ 50/60Hz
- power consumption: 420mA at 100V~/220mA at 230V~
- standby power consumption: <100mW at 230V~
- Output power: 20 W Max
- Output:
  - USB tip C: 5.0 VDC 3.0A; 9.0 VDC 2.2 A; 12.0 VDC 1.67 A (PD 20W)
  - USB tip A: 5.0 VDC 3.0A; 9.0 VDC 2.0 A; 12.0 VDC 1.5 A (QC 18W)
  - USB A+C: 5 VDC 3A
- connector type: 1x USB A; 1x USB C
- average efficiency in active mode: 86%
- efficiency with low load (10%): 81%
- operating temperature: 0°C/+45°C (indoor use)
- IP protection class: IP20, indoor use only
- class device II
- overvoltage category (EN 60364-4-44): Class III
- screw contacts: max. 2.5 mm<sup>2</sup>
- device with a contact gap of at least 3mm
- Conformity:
  - Directive: BT, EMC, RoHS, ErP
  - Standards: EN IEC 62368-1, EN 55032, EN55035, EN IEC 61000-3-2, EN 61000-3-3, EN 50563, EN IEC 63000
  - External power supplies regulation: (EU) n. 2019/1782 REACH, n. 1907/2006 – art.33. The product may contain traces of lead.

LED AMBIENTALNA ENOTA ENOBARVNA 250V~ 0,8W 2M

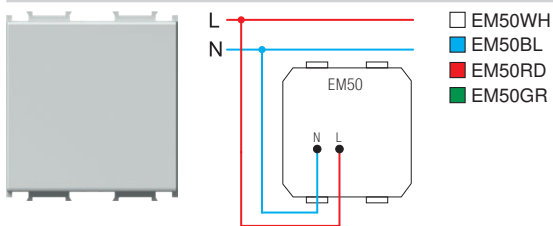

- LED ambientalna enota za stopnišča in hodnike
- napajanje 230V~ 50Hz 0,8W, 6500K
- razred zaščite II
- ustreza EN 60598-1
- uporaba tudi za usmerjanje ali signalizacijo z možnostjo laserskega tiska poljubne grafike



LED AMBIENT UNIT MONOCOLOUR 250V~ 0,8W 2M

- step marker LED unit
- supply voltage 230V~ 50Hz 0,8W, 6500K
- Class II
- in accordance with EN 60598-1
- optional usage for directional signalization with customized laser printing on diffuser

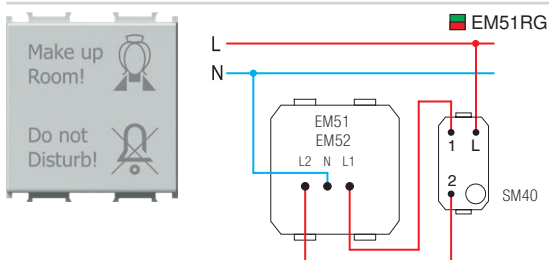

SVETILKA LED DVOBARVNA 250V~ 2x0,4W 2M

- LED dvoobarvna svetilka (rdeča/zelena) za signalizacijo
- napajanje 230V~ 50Hz 2x0,4W, 6500K
- razred zaščite II
- ustreza EN 60598-1
- vsebuje grafiko kot na sliki
- možnost laserskega tiska poljubne grafike

LED LAMP DUAL COLOR 250V~ 2x0,4W 2M

- signaling dual color (red/green) LED lamp
- supply voltage 230V~ 50Hz 2x0,4W, 6500K
- Class II
- in accordance with EN 60598-1
- diffuser includes graphics as shown
- possible customized laser printing on diffuser

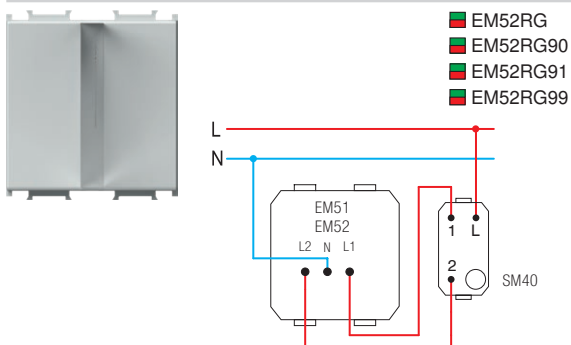

SVETILKA LED 3D DVOBARVNA 250V~ 2x0,4W 2M

- LED dvoobarvna svetilka (rdeče/zelena) s 3D simbolom, za signalizacijo
- napajanje 230V~ 50Hz 2x0,4 W, 6500K
- razred zaščite II
- ustreza EN 60598-1
- možnost tiska različnih grafik po naročilu
- 90 moški simbol, 91 ženski simbol, 99 simbol po naročilu

LED LAMP 3D DUAL COLOR 250V~ 2x0,4W 2M

- signalling LED lamp, dual color (red/green) with 3D symbol
- supply voltage 230V~ 50Hz 2x0,4W, 6500K
- class II
- in accordance with EN 60598-1
- possible customized graphics on request
- 90 male symbol, 91 female symbol, 99 symbol on request

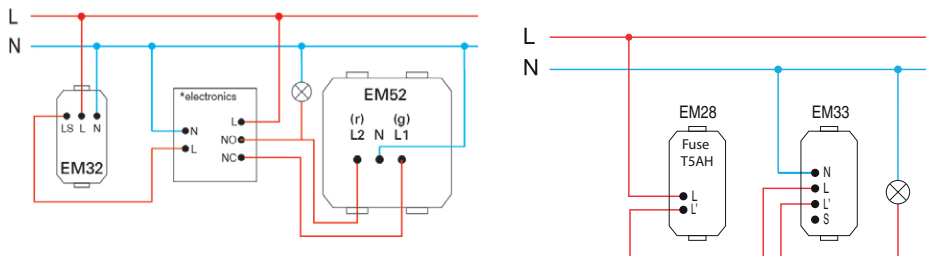
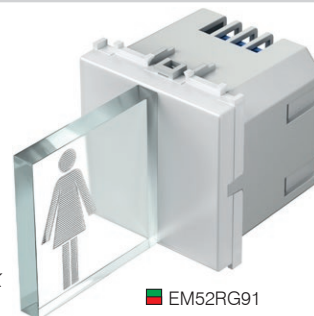

2M = 45 x 45

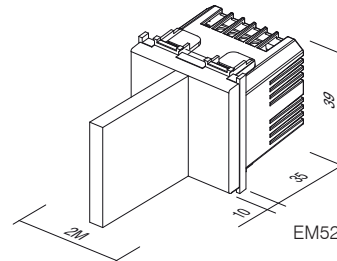
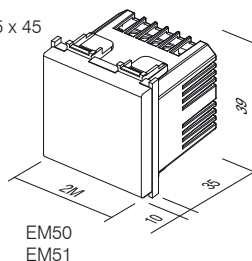

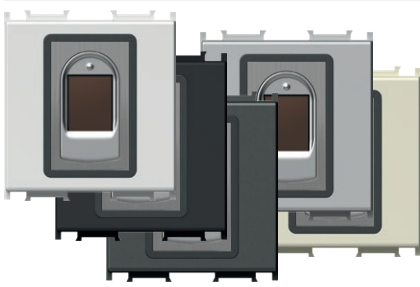

- EM71PW
- EM71MW
- EM71SB
- EM71AT
- EM71ES
- EM71IW

**STIKALO NA PRSTNI ODTIS BIOPASS 2M**

- stikalo na prstni odtis v kompletu z notranjo rele enoto in napajalnikom
- kapaciteta: 500 prstnih odtisov
- enostavno upravljanje prek mobilne aplikacije X-Manager
- napajalna napetost: 8-30 V – DC ali AC (napajalnik priložen)
- kapacitivni senzor
- 2 izhodna releja
- maksimalna napetost/tok na releju: 40V/3A
- čas proženja releja: 1 - 10 s
- maksimalna moč: 3,6 W
- Temperaturno območje delovanja: -30 °C do +80 °C
- Maksimalna vlažnost okolice do: 100 % IP65
- 256-bitna enkripcija povezave med stikalom in notranjo rele enoto
- Set vključuje tudi nosilec NM24 in dekorativni okvir OS20.

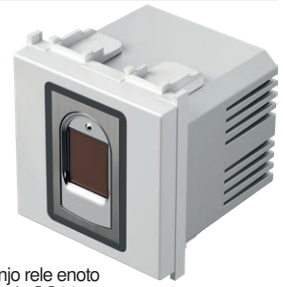

**FINGERPRINT SWITCH BIOPASS 2M**

- fingerprint switch with included internal relay unit and power supply
- capacity: 500 fingerprints
- easy management via X-Manager mobile app
- power supply voltage: 8-30V – DC or AC (power supply included)
- capacitive sensor
- 2 output relays
- maximum voltage/current on relay: 40V/3A
- relay triggering time: 1-10 sec
- maximum power: 3.6W
- 256-bit encrypted link between switch and internal relay unit
- Set also includes NM24 mounting frame and OS20 decorative cover plate.

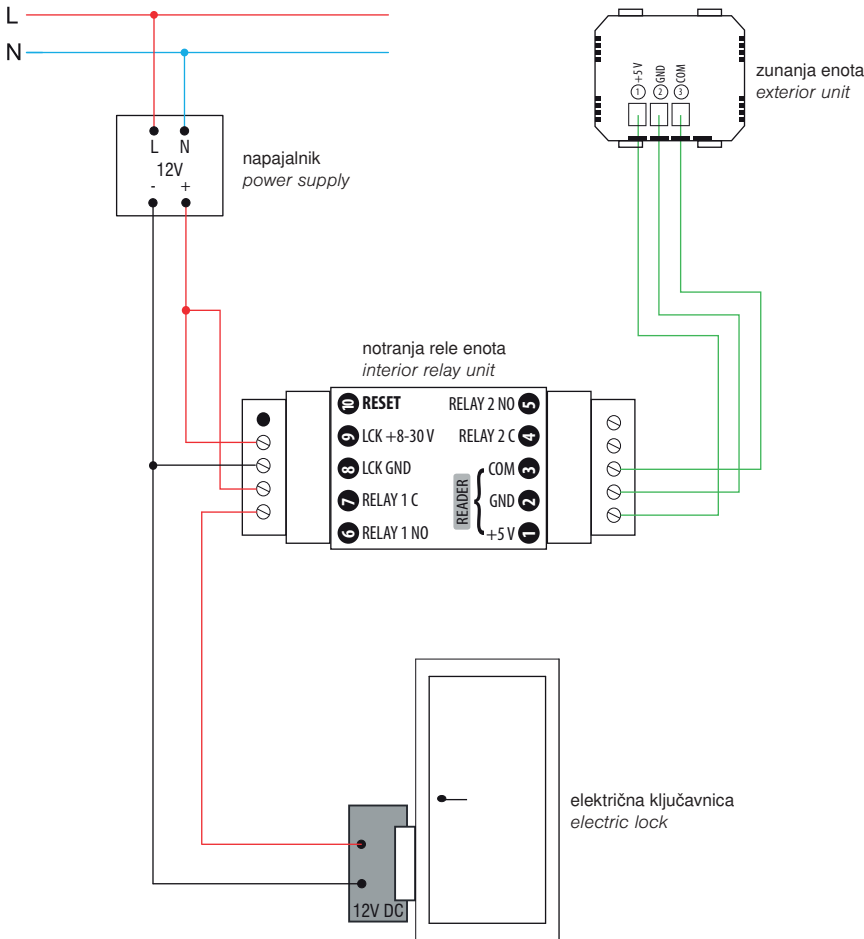

**X-Manager app**

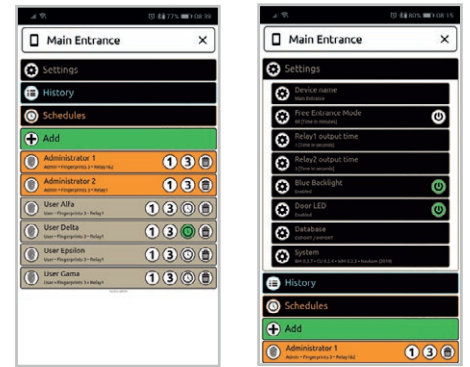

zunanja enota  
exterior unit

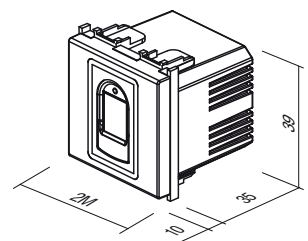



- EM82PW
- EM82MW
- EM82SB
- EM82AT
- EM82ES
- EM82IW



VEČOPRAVILNO ČASOVNO STIKALO EM82

- Napajalna napetost: 230 V~, 50Hz
- Izhod: Rele 16 A / 250 V~, 50Hz
- Presek žic: 0,75 – 4,0 mm<sup>2</sup>
- Temperatura delovanja: 0 do +40 °C
- Temperatura skladiščenja: -5 do +60 °C
- Funkcije: **Casovnik, Rele (krmiljeno stikalo), Stikalo, Tipkalo**
- Indikacija programa / stanja: RGB LED
- Število tipk: 2
- Vrsta delovanja tipke: Kapacitivno
- Število priključkov: 6 - 2x N, 2x L, 1x Izhod (L'), 1x Krmiljen vhod (S)
- Možnost krmiljenega vhoda: Da. Priključitev signala omrežne napetosti (230 V~) na sponko S
- Implementirano delovanje »zero crossing« (preklop stikala ob prehodu napetosti skozi 0 V)
- Poraba v stanju OFF / ON: 0,3 W / 1,0 W
- Stikalo EM82 NI PRIMERNO za vgradnjo v podometne doze globine 45 mm in ohišja CUBO IP20.
- Stikalo je namenjeno za uporabo v notranjih prostorih, zaščitene pred vplivom vlage.

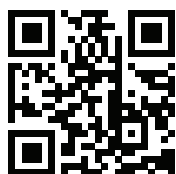

MULTIPURPOSE TIMER SWITCH EM82

- Supply voltage: 230 V~, 50Hz
- Output: Rele 16 A / 250 V~, 50Hz
- Wire cross section: 0,75 – 4,0 mm<sup>2</sup>
- Operating temperature: 0 to +40 °C
- Storage temperature: -5 to +60 °C
- Functions: **Timer, Relay (controlled switch), Switch, Push button**
- Program/status indication: RGB LED
- Number of buttons: 2
- Push button operation type: Capacitive
- Number of ports: 6 - 2x N, 2x L, 1x Output (L'), 1x Controlled input (S)
- Controlled input option: Yes. Connection of the main voltage signal (230 V~) to terminal S.
- Implemented "zero crossing" operation (switching the switch when the voltage passes through 0 V)
- Power consumption in the OFF / ON state: 0.3 W / 1.0 W
- The EM82 switch is NOT SUITABLE for installation in concealed boxes with a depth of 45 mm and CUBO IP20 housing.
- The switch is intended for indoor use, protected from moisture.

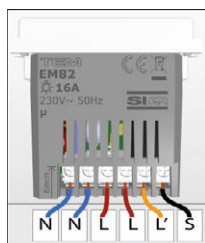
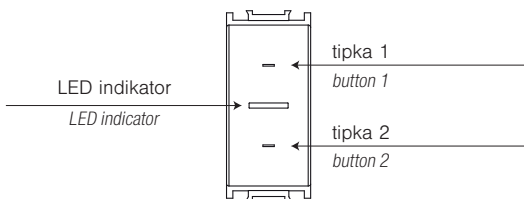

- N Nevtralni vodnik
- L Fazni vodnik
- L' Izhod (krmiljena faza)
- S Vhodni krmilni signal (230 V~)

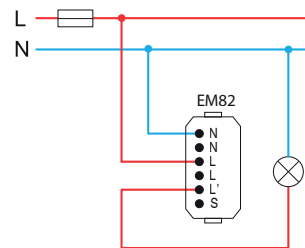

EM82 is in a SWITCH or a TIMER mode

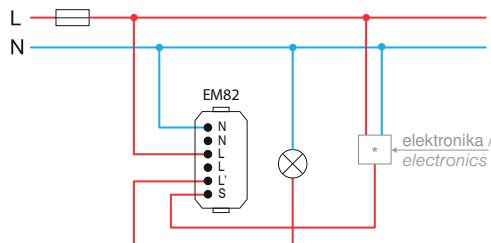

EM82 is in a RELAY mode

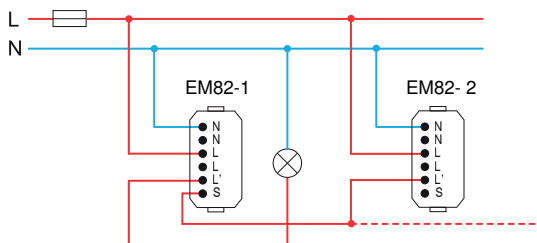

EM82-1 is in a SWITCH or a TIMER mode  
EM82-2 is in a PUSH BUTTON mode

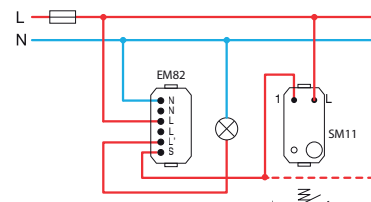

EM82 is in a SWITCH or a TIMER mode

	1	2	3	4	5	6	7	8
Max.	16 A	16 A	16 A	8 A	8 A	5 A cos φ=0.6	200 VA	200 VA

- 1 - incandescent lamp
- 2 - halogen lamp
- 3 - resistive heating element
- 4 - electronic transformer
- 5 - classical transformer
- 6 - motor
- 7 - energy saving CFL lamp
- 8 - LED lamp

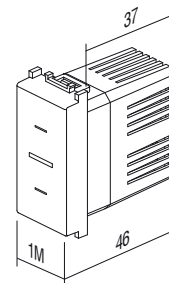

Operation of the control signal S – MODE 1

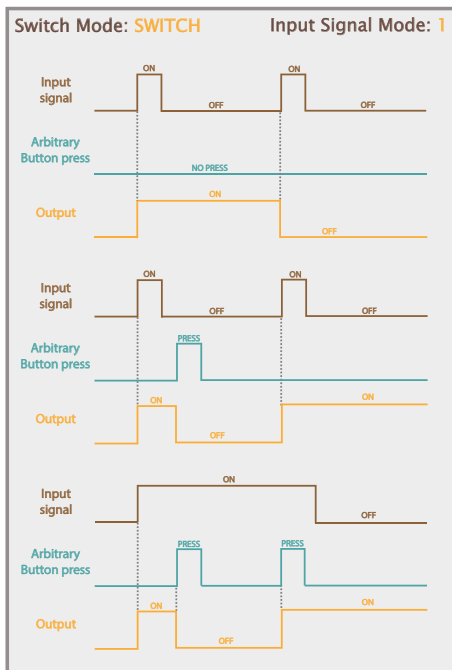

Display of the operation of the external signal S and buttons in the SWITCH operating mode and external signal in MODE 1

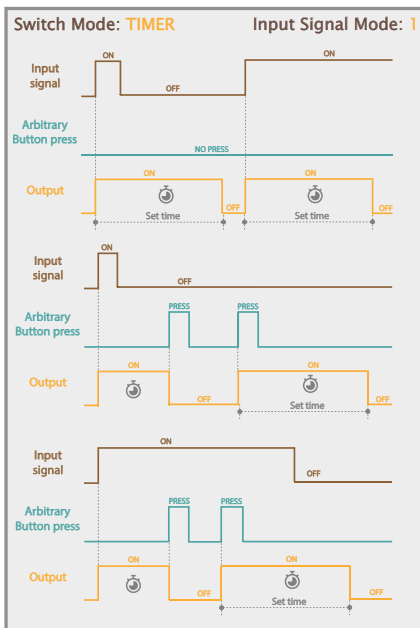

Display of the operation of the external signal S and buttons in the TIMER operating mode and external signal in MODE 1

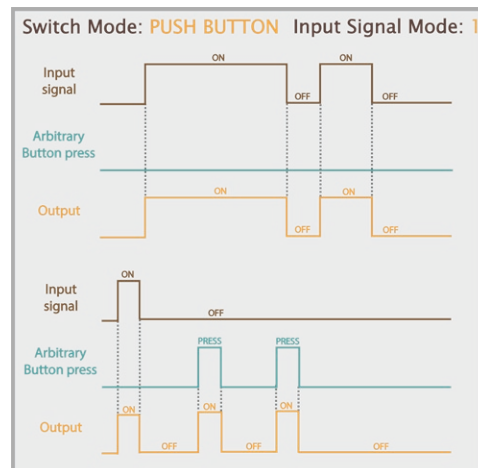

Display of the operation of the external signal S and buttons in the PUSH BUTTON operating mode and external signal in MODE 1

OPERATION OF THE CONTROL SIGNAL S – MODE 2

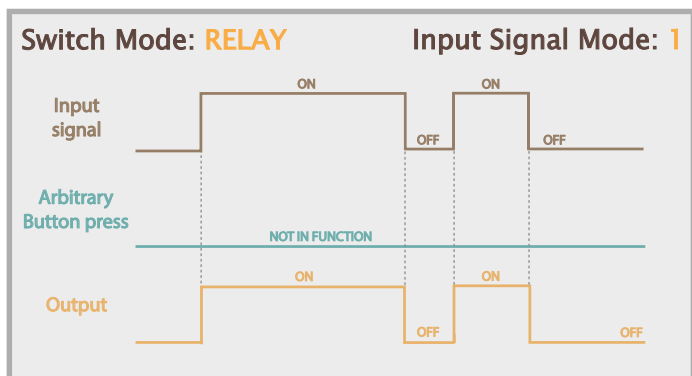

Display of the operation of the external signal S and buttons in the RELAY operating mode and external signal in MODE 1

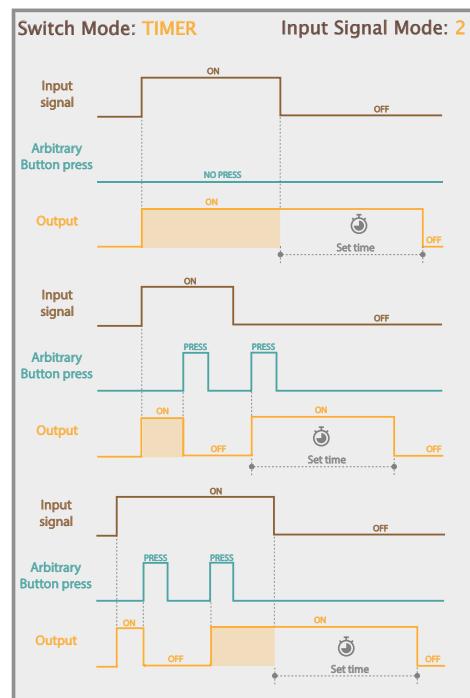

Display of the operation of the external signal S and buttons in the TIMER operating mode and external signal in MODE 2

Operating mode settings of the external control signal S

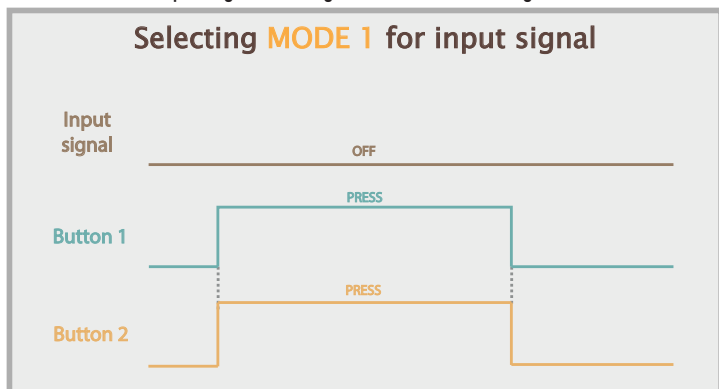

Setting the operating mode of the input signal S for MODE 1

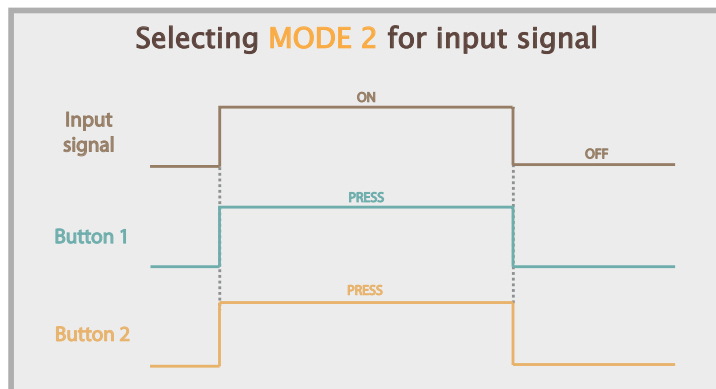

Setting the operating mode of the input signal S for MODE 2

**BREŇAĀ 8VA 230V~ 1M**

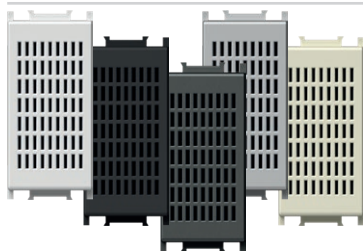

- EM90PW
- EM90MW
- EM90SB
- EM90AT
- EM90ES
- EM90IW

- signalni breŇaĀ
- dolŇina zvoka je enaka dolŇini pritiska na tipko
- napajanje 230V~ 50Hz 8VA

**BUZZER 8VA 230V~1M**

- signal buzzer
- the sound emission has the same lasting time as the control operation
- supply voltage 230V~ 50Hz 8VA



**BREŇAĀ 8VA 12V~ 1M**

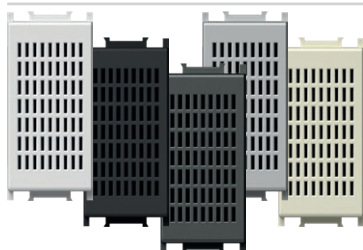

- EM91PW
- EM91MW
- EM91SB
- EM91AT
- EM91ES
- EM91IW

- signalni breŇaĀ
- dolŇina zvoka je enaka dolŇini pritiska na tipko
- napajanje 12V~ 50Hz 8VA

**BUZZER 8VA 12V~1M**

- signal buzzer
- the sound emission has the same lasting time as the control operation
- supply voltage 12V~ 50Hz 8VA



**ZVONEC 8VA 230V~ 1M**

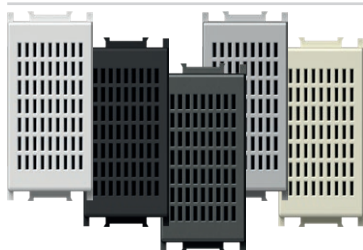

- EM92PW
- EM92MW
- EM92SB
- EM92AT
- EM92ES
- EM92IW

- signalni zvonec
- dolŇina zvoka je enaka dolŇini pritiska na tipko
- napajanje 230V~ 50Hz 8VA

**BELL 8VA 230V~1M**

- signal bell
- the sound emission has the same lasting time as the control operation
- supply voltage 230V~ 50Hz 8VA



ZVONEC 8VA 12V~ 1M

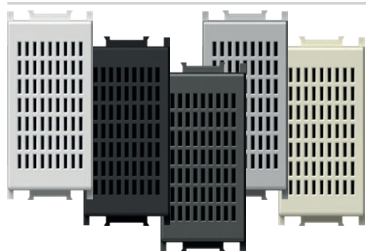

- EM93PW
- EM93MW
- EM93SB
- EM93AT
- EM93ES
- EM93IW

- signalni zvonec
- dolžina zvoka je enaka dolžini pritiska na tipko
- napajanje 12V~ 50Hz 8VA

BELL 8VA 12V~1M

- signal bell
- the sound emission has the same lasting time as the control operation
- supply voltage 12V~ 50Hz 8VA



ELEKTRONSKI ZVONEC 230V~ 6mA rms 1M

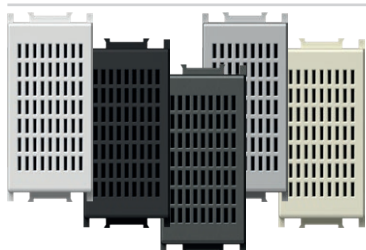

- EM94PW
- EM94MW
- EM94SB
- EM94AT
- EM94ES
- EM94IW

- napajanje 230 V~ 50/60 Hz
- poraba melodija 1; 4,7 mA rms
- poraba melodija 2; 5,9 mA rms
- nivo zvoka melodija 1; 90,5 dB
- nivo zvoka melodija 2; 86 dB
- temperatura delovanja: 0°C/45 °C (notranja uporaba)
- temperatura skladiščenja -20°C /50 °C
- IP zaščitni razred : IP20 (samo za notranjo uporabo)
- varnostni razred naprave II
- prenapetostna zaščita (EN62109): razred III
- vijačna pritrditev vodnikov max. 2,5 mm<sup>2</sup>
- naprava z odmikom kontaktov min. 3mm
- zvonec mora biti varovan z ustreznim zunanjim odklopnikom
- direktivi EMC in LVD

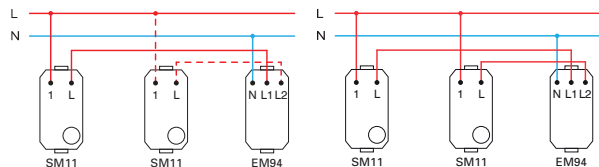
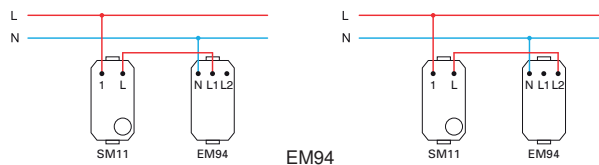

ELECTRONIC BELL 230V~ 6mA rms 1M

- power supply 230 V~ 50/60 Hz
- power consumption when playing melody 1: 4.7 mA rms
- power consumption when playing melody 2: 5.9 mA rms
- sound level of melody 1: 90.5 dB
- sound level of melody 2: 86 dB
- operating temperature 0°C/45°C (indoor use)
- storage temperature: -20°C /50°C
- IP protection class: IP20 (indoor use only)
- class device II
- overvoltage category (EN62109): Class III
- screw contacts: max. 2.5 mm<sup>2</sup>
- device with a contact gap of at least 3 mm
- an easily accessible cut-off switch must be installed upstream from bell
- complies with EMC & LVD directives

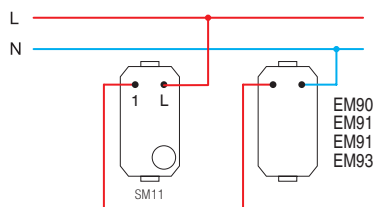
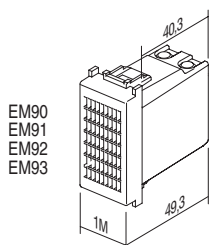

REGULATOR GLASNOSTI ZA 100V AVDIO LINIJO 35W 2M



- EM95PW
- EM95MW
- EM95SB
- EM95AT
- EM95ES
- EM95IW

- regulator glasnosti (atenuator ) za 100V avdio sisteme
- nazivna moč 35W ( max. 45W), 6 stopenjska nastavitve glasnosti
- primeren za vgradnjo v globoke doze (min. 60 mm)
- ni primeren za vgradnjo v doze globine 45 mm in ohišja CUBO IP20
- samo za notranjo uporabo



- VOLUME CONTROL 100V AUDIO LINE 35W 2M**
- volume control (attenuator) for 100V audio systems
  - power rating 35W (max.45W), 6 steps volume control
  - suitable for boxes min. 60 mm deep
  - not suitable for installation in 45 mm deep boxes and surface mount boxes CUBO IP20
  - for indoor use only

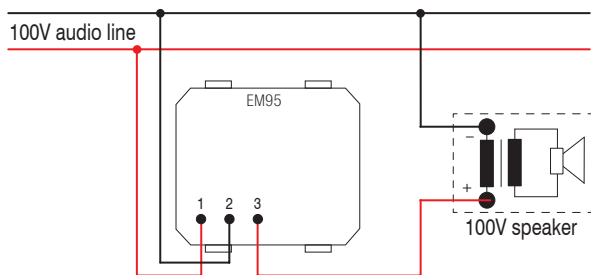

REGULATOR GLASNOSTI NIZKOOHMSKI 4-8 Ω 35W 2M



- EM96PW
- EM96MW
- EM96SB
- EM96AT
- EM96ES
- EM96IW

- regulator glasnosti za nizkonapetostne izhode 4-8 Ω 35W
- za priklop na HI-FI naprave
- nazivna moč 35W, 6 stopenjska nastavitve glasnosti
- primeren za vgradnjo v globoke doze (min. 60 mm)
- ni primeren za vgradnjo v doze globine 45 mm in ohišja CUBO IP20
- samo za notranjo uporabo



- VOLUME CONTROL 4-8 Ω 35W 2M**
- volume control (attenuator) for low voltage outputs 4-8 Ω, 35W
  - power rating 35W, 6 steps volume control
  - suitable for boxes min. 60 mm deep
  - not suitable for installation in 45 mm deep boxes and surface mount boxes CUBO IP20
  - for indoor use only

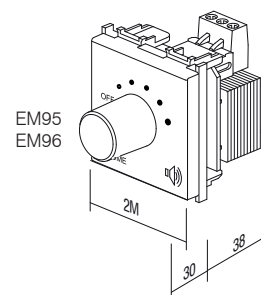
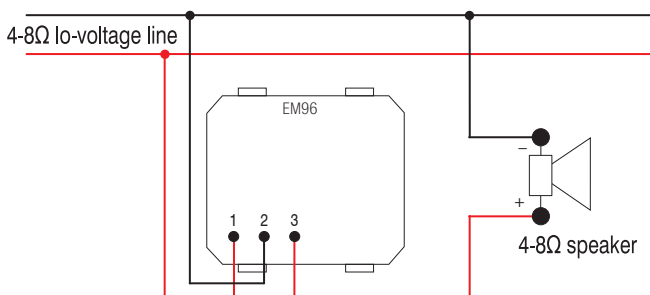



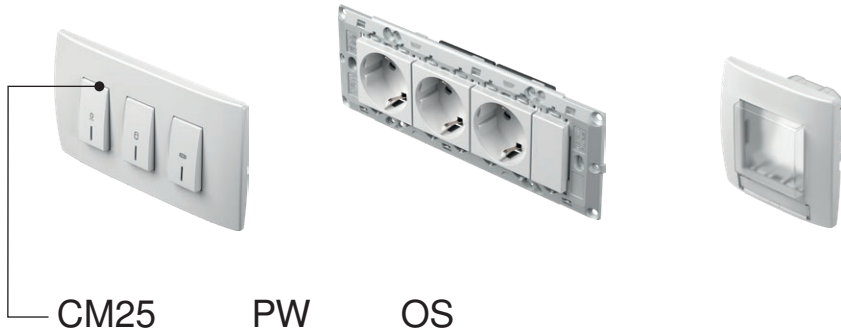

tip type	naziv description	tehnični opis technical data	velikost size	barva colour	opcijski opis 1 optional data 1
CM10	SET VTIČNIC 2x SCHUKO SOCKET SET 2x SCHUKO	2P+E 16A 250V~	4M	<input type="checkbox"/> PW bela-sijaj polar white	<input type="checkbox"/> OL okvir LINE cover plate LINE
CM11	SET VTIČNIC 3x SCHUKO SOCKET SET 3x SCHUKO	2P+E 16A 250V~	7M	<input type="checkbox"/> MW bela- mat matte white	<input type="checkbox"/> OS okvir SOFT cover plate SOFT
CM15	SET VEZNIKOV BARVNI LINK WIRE SET	3x1.5mm <sup>2</sup>	1M	<input checked="" type="checkbox"/> SB črna-mat soft touch black	
⋮	⋮	⋮	⋮	<input checked="" type="checkbox"/> AT antracit anthracite	
⋮	⋮	⋮	⋮	<input type="checkbox"/> ES srebrna elox silver	
⋮	⋮	⋮	⋮	<input type="checkbox"/> IW bež-sijaj ivory white	

#### SET VTIČNIC 2x SCHUKO 2P+E 16A 250V~ 4M

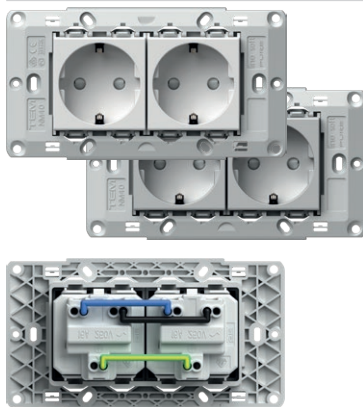

- CM10PW
- CM10ES

- set vtičnic 2x schuko VM10 2P+E 16A 250V~
- vtičnici povezani z vezniki CM16
- z nosilcem 4M brez vijakov
- za pritrnitev nosilcev uporabiti vijake CM17, CM18 ali CM19
- vijačna pritrnitev vodnikov 1.5-2.5 mm<sup>2</sup>
- ustreza IEC 60884-1, CEE7

#### SOCKETS SET 2x SCHUKO 2P+E 16A 250V~ 4M

- socket set 2x schuko VM10 2P+E 16A 250V~
- prewired with link wires CM16
- with mounting frame 4M without screws
- for mounting frame fixing use screws CM17, CM18 or CM19
- screw contacts 1.5-2.5 mm<sup>2</sup>
- in accordance with IEC-60884-1, CEE7

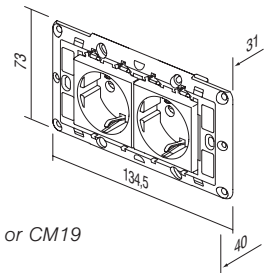

#### SET VTIČNIC 3x SCHUKO 2P+E 16A 250V~ 7M

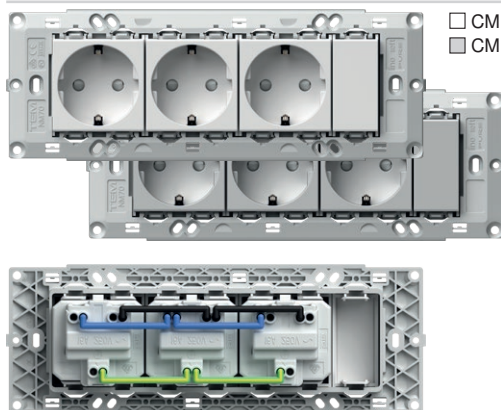

- CM11PW
- CM11ES

- set vtičnic 3x schuko VM10 2P+E 16A 250V~
- vtičnice povezane z vezniki CM16
- z nosilcem 7M brez vijakov
- za pritrnitev nosilcev uporabiti vijake CM17, CM18 ali CM19
- vijačna pritrnitev vodnikov 1.5-2.5 mm<sup>2</sup>
- ustreza IEC 60884-1, CEE7

#### SOCKETS SET 3x SCHUKO 2P+E 16A 250V~ 7M

- socket set 3x schuko VM10 2P+E 16A 250V~
- prewired with link wires CM16
- with mounting frame 7M without screws
- for mounting frame fixing use screws CM17, CM18 or CM19
- screw contacts 1.5-2.5 mm<sup>2</sup>
- in accordance with IEC-60884-1, CEE7

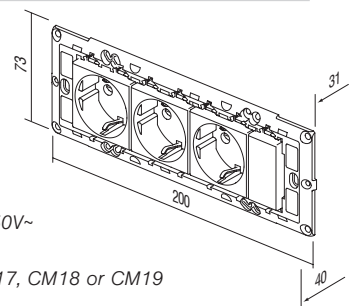

### SET VEZNIKOV BARVNI 3x1.5mm<sup>2</sup> 1M

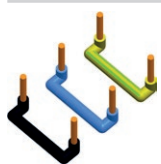

CM15

- set veznikov za povezavo dveh elementov velikosti 1M
- vsebuje 10 črnih, 10 modrih in 10 rumeno-zelenih veznikov

#### LINK WIRE SET 3x1.5mm<sup>2</sup> 1M

- link wire set to connect two elements size 1M
- includes 10 black, 10 blue and 10 yellow/green wires

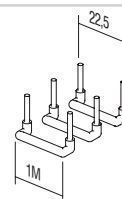

### SET VEZNIKOV BARVNI 3x2.5mm<sup>2</sup> 2M

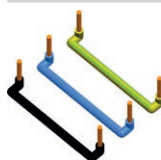

CM16

- set veznikov za povezavo dveh elementov velikosti 2M
- vsebuje 10 črnih, 10 modrih in 10 rumeno-zelenih veznikov

#### LINK WIRE SET 3x2.5mm<sup>2</sup> 2M

- link wire set to connect two elements size 2M
- includes 10 black, 10 blue and 10 yellow/green wires

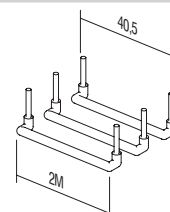

### SET VIJAKOV 3,5

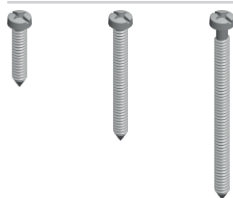

CM17

CM18

CM19

- set vijakov za pritrnitev nosilcev setov NM30, NM32, NM40, NM41, NM70
- CM17 - l=20mm, 100kos
- CM18 - l=35mm, 50kos
- CM19 - l=50mm, 50kos



#### SCREW SET 3,5

- screw set for fixing mounting frames NM30, NM32, NM40, NM41, NM70
- CM17 - l=20mm, 100pcs
- CM18 - l=35mm, 50pcs
- CM19 - l=50mm, 50pcs

### SET ZA STIKALA Z NAPISNO PLOŠČICO IP44 2M



CM22PW

CM22MW

CM22SB

CM22AT

CM22ES

CM22IW

- za vgradnjo v vlažne prostore
- IP44 zaščito zagotavlja za vsa stikala Modul
- stikala in tipke niso sestavni del seta
- vsebuje okvir SOFT 2M z napisno ploščico in nosilec
- ustreza IEC 60669-1

#### SET SWITCHES WITH INSCRIPTION PLATE IP44 2M

- for usage in humid areas
- IP44 protection provides for all Modul switches
- switches and buttons are not part of the set
- include SOFT 2M cover plate with inscription plate and mounting fame
- in accordance with IEC 60669-1



### SET ZA VTIČNICE Z NAPISNO PLOŠČICO IP44 2M



CM23PW

CM23MW

CM23SB

CM23AT

CM23ES

CM23IW

- za vgradnjo v vlažne prostore
- IP44 zaščito zagotavlja le v kombinaciji z vtičnico s pokrovom (VM11, VM41)
- vtičnice niso sestavni del seta
- vsebuje okvir SOFT 2M z napisno ploščico in nosilec
- ustreza IEC 60884-1

#### SET SOCKETS WITH INSCRIPTION PLATE IP44 2M

- for usage in humid areas
- IP44 protection can be achieved only in combination with covered socket (VM11, VM41)
- sockets are not part of the set
- include SOFT 2M cover plate with inscription plate and mounting fame
- in accordance with IEC 60884-1



### KOPALNIŠKI SET 3x20A 250V~ 4M

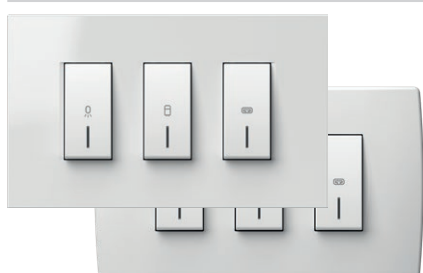

CM25PWOL

CM25IWOL

CM25PWOS

CM25IWOS

- set stikal 3xSM12 20A 250V~ z nosilcem in okvirjem
- vijalna pritrnitev vodnikov 1.5-2.5mm<sup>2</sup>
- ustreza EN 60669-1
- možnost pritrditve na že vgrajene doze pritrditvenih mer od 108 do 135mm ali na doze velikosti 4M
- višina okvirja 90mm

#### SWITCH SET FOR BATHROOM 3x20A 250V~ 4M

- switch set 3xSM12 20A 250V~ with mounting frame and cover plate
- screw contacts 1.5-2.5mm<sup>2</sup>
- in accordance with EN 60669-1
- universal solution for renovation on boxes with fixing dimensions 108-135mm or boxes 4M size
- cover plate height 90mm

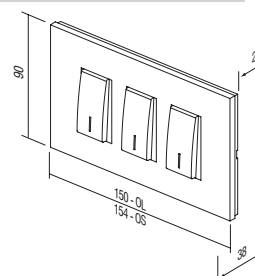



- CM28PW
- CM28MW
- CM28SB
- CM28AT
- CM28ES
- CM28IW

#### SET ZA STIKALA IP44 2M

- za vgradnjo v vlažne prostore
- IP44 zaščito zagotavlja za vsa stikala Modul
- stikala in tipke niso sestavni del seta
- okvir SOFT 2M brez napisne ploščice
- ustreza IEC 60669-1

#### SET SWITCHES IP44 2M

- for usage in humid areas
- IP44 protection provides for all Modul switches
- switches and buttons are not part of the set
- SOFT 2M cover plate without inscription plate
- in accordance with IEC 60669-1



- CM29PW
- CM29MW
- CM29SB
- CM29AT
- CM29ES
- CM29IW

#### SET ZA VTIČNICE IP44 2M

- za vgradnjo v vlažne prostore
- IP44 zaščito zagotavlja le v kombinaciji z vtičnico s pokrovom (VM11, VM41)
- vtičnice niso sestavni del seta
- okvir SOFT 2M brez napisne ploščice
- ustreza IEC 60884-1

#### SET SOCKETS IP44 2M

- for usage in humid areas
- IP44 protection can be achieved only in combination with covered socket (VM11, VM41)
- sockets are not part of the set
- SOFT 2M cover plate without inscription plate
- in accordance with IEC 60884-1

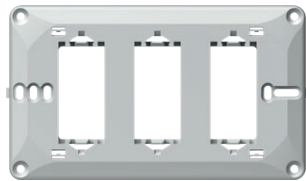

NM41

#### NOSILEC KOPALNIŠKI SET 4M

- nosilec kopalniški set univerzalni z vijaki
- možnost pritrditve na že vgrajene pravokotne doze pritrditvenih mer od 108 do 135mm ali na doze velikosti 4M
- ustreza EN 60669-1

#### MOUNTING FRAME BATHROOM SET 4M

- universal mounting frame for bathroom set with screws
- universal solution for mounting on rectangular boxes with fixing dimensions 108-135mm or boxes 4M size
- in accordance with EN 60669-1

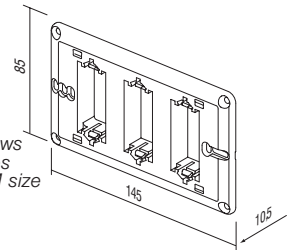

- OL41PW
- OL41MW
- OL41NB
- OL41IW
- OL41ES
- OL41SG
- OL41IB
- OL41AT
- OL41TI
- OL41SB

#### OKVIR LINE KOPALNIŠKI SET

- dekorativni okvir kopalniški set LINE
- višina 90mm
- ustreza EN 60669-1

#### COVER PLATE LINE BATHROOM SET

- decorative cover plate bathroom set LINE
- height 90mm
- in accordance with EN 60669-1

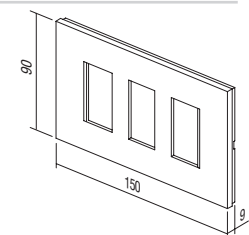

- OS41PW
- OS41MW
- OS41NB
- OS41IW
- OS41ES
- OS41SG
- OS41SB
- OS41WE
- OS41AT
- OS41TI

#### OKVIR SOFT KOPALNIŠKI SET

- dekorativni okvir kopalniški set SOFT
- višina 90mm
- ustreza EN 60669-1

#### COVER PLATE SOFT BATHROOM SET

- decorative cover plate bathroom set SOFT
- height 90mm
- in accordance with EN 60669-1

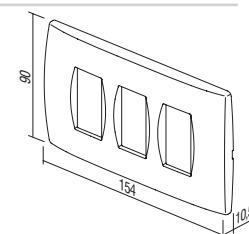

# ANTIBAKTERIJSKI PROGRAM MODUL

tip type	naziv description	velikost size	barva colour	opsijski opis 1 optional data 1
TM11	TIPKA BUTTON	1M	<input type="checkbox"/> AW antibakterijsko bela antibacterial white	NT nevtral neutral
TM21	POLNILO BLANK	1M		
VM10	VTIČNICA SOCKET	2M		IN indikator indicator
.	.	.		
.	.	.		

## ANTIBAKTERIJSKI PROGRAM MODUL

- stikala in vtičnice so vsakodnevno izpostavljene dotiku večjega števila ljudi, zato so to pogosta mesta za razvoj in širjenje bakterij
- zahvaljujoč svojim naravnim antibakterijskim lastnostim je srebro že 3 tisočletja v uporabi kot varno in učinkovito dezinfekcijsko sredstvo, saj je popolnoma naravno ter zdravju in okolju prijazno
- poseben antibakterijski dodatek srebrnih ionov zagotavlja dolgoročno, zanesljivo in učinkovito zaščito pred razvojem in širjenjem različnih bakterij, mikrobov in glivic
- antibakterijska zaščita pomeni večjo higiensko, čistočo in zdravje ljudi
- antibakterijski program MODUL je primeren za uporabo povsod, kjer veljajo strogi higienski pogoji (bolnišnice, zdravstveni domovi, farmacevtski objekti, domovi za starejše, negovalni domovi, laboratoriji, restavracije, hoteli, letališča, avtobusne in železniške postaje, poslovni in trgovski prostori, javne institucije ...)
- laboratorijska testiranja so bila opravljena v neodvisni instituciji na podlagi najvišjih japonskih standardov JIS Z 2801
- nizki stroški za zagotavljanje zdravja ljudi
- oblika in funkcionalnost antibakterijskega programa MODUL omogočata enostavno čiščenje in vzdrževanje
- antibakterijski program MODUL kombiniramo z antibakterijskimi tipkami, okvirji in vtičnicami skupaj s klasičnimi nosilci in stikali
- vsak izdelek je zaradi lažje identifikacije na zadnji strani označen z AW (antibacterial white)

## ANTIBACTERIAL PROGRAM MODUL

- switches and sockets are daily touched by many people, so this is a common place for development and spread of bacteria
- thanks to its natural antibacterial characteristics silver has been used for three millennia as a safe and effective disinfectant, since it is completely natural, healthy and environmentally friendly
- special antibacterial silver ions additive provides long-term, reliable and effective protection against the development and spread of bacteria, microbes and fungi
- antibacterial protection ensures hygiene, cleanliness and health for people
- perfectly suitable for use in environments with strict hygiene conditions (hospitals, health centers, pharmaceutical facilities, homes for elderly, nursing homes, laboratories, restaurants, hotels, airports, bus and railway stations, business and shopping areas, public institutions ...)
- independent laboratory testings have been carried out in accordance with highest Japanese standards JIS Z 2801
- low cost for providing human health
- design and functionality of antibacterial program MODUL allow easy cleaning and maintenance
- antibacterial buttons, cover plates and sockets are combined with classic mounting frames and switches
- products are labelled on the back with AW (antibacterial white)

## A N T I B A C T E R I A L P R O G R A M M O D U L

	□ TM11AW	<b>TIPKA 1M</b> - zamenljiva tipka velikosti 1M - ustreza EN 60669-1 - antibakterijska zaščita skladna z JIS Z 2801	
	□ TM11AWIN	<b>TIPKA 1M INDIKATOR</b> - zamenljiva tipka velikosti 1M - ustreza EN 60669-1 - antibakterijska zaščita skladna z JIS Z 2801  <i>BUTTON 1M INDICATOR</i> - replaceable button 1M - in accordance with EN 60669-1 - antibacterial protection in accordance with JIS Z 2801	
	□ TM12AW	<b>TIPKA 2M</b> - zamenljiva tipka velikost 2M z nosilcem tipke - uporablja se pri nadgradnji stikala ali tipkala velikosti 1M v velikost 2M - ustreza EN 60669-1 - antibakterijska zaščita skladna z JIS Z 2801  <i>BUTTON 2M</i> - replaceable button 2M with button carrier - to upgrade switch or push button from size 1M to size 2M - in accordance with EN 60669-1 - antibacterial protection in accordance with JIS Z 2801	
	□ TM12AWIN	<b>TIPKA 2M INDIKATOR</b> - zamenljiva tipka velikost 2M z nosilcem tipke - uporablja se pri nadgradnji stikala ali tipkala velikosti 1M v velikost 2M - ustreza EN 60669-1 - antibakterijska zaščita skladna z JIS Z 2801  <i>BUTTON 2M INDICATOR</i> - replaceable button 2M with button carrier - to upgrade switch or push button from size 1M to size 2M - in accordance with EN 60669-1 - antibacterial protection in accordance with JIS Z 2801	
	□ TM21AW	<b>POLNILO 1M</b> - za zapolnjevanje praznih mest - ustreza EN 60669-1 - antibakterijska zaščita skladna z JIS Z 2801  <i>BLANK 1M</i> - blank modul to fill up empty spaces - in accordance with EN 60669-1 - antibacterial protection in accordance with JIS Z 2801	
	□ TM22AW	<b>POLNILO 2M</b> - za zapolnjevanje praznih mest - ustreza EN 60669-1 - antibakterijska zaščita skladna z JIS Z 2801  <i>BLANK 2M</i> - blank modul to fill up empty spaces - in accordance with EN 60669-1 - antibacterial protection in accordance with JIS Z 2801	



□ VM10AW

**VTIČNICA SCHUKO+KS 2P+E 16A 250V~ 2M**

- 2P+E schuko
- 16A 250V~, tip VM10
- ustreza IEC 60884-1, CEE7
- vijajčna pritrditev vodnikov 1.5-2.5 mm<sup>2</sup>
- vgrajena zaščita pred dotikom kontaktov
- antibakterijska zaščita skladna z JIS Z 2801

**SOCKET SCHUKO+KS 2P+E 16A 250V~ 2M**

- 2P+E schuko
- 16A 250V~, type VM10
- in accordance with IEC 60884-1, CEE7
- screw contacts 1.5-2.5 mm<sup>2</sup>
- built-in contact protection
- antibacterial protection in accordance with JIS Z 2801



□ VM11AW

**VTIČNICA SCHUKO+KS+POKROV 2P+E 16A 250V~ 2M**

- 2P+E schuko+pokrov
- 16A 250V~, tip VM11
- ustreza IEC 60884-1, CEE7
- vijajčna pritrditev vodnikov 1.5-2.5 mm<sup>2</sup>
- vgrajena zaščita pred dotikom kontaktov
- antibakterijska zaščita skladna z JIS Z 2801

**SOCKET SCHUKO+KS+COVER**

- 2P+E 16A 250V~ 2M
- 2P+E schuko+cover
- 16A 250V~, type VM11
- in accordance with IEC 60884-1, CEE7
- screw contacts 1.5-2.5 mm<sup>2</sup>
- built-in contact protection
- antibacterial protection in accordance with JIS Z 2801



□ VM20AW

**VTIČNICA EURO+KS 2P 10A 250V~ 1M**

- 2P euro
- 10A 250V~, tip VM20
- ustreza IEC 60884-1, CEE7
- vijajčna pritrditev vodnikov 1.5-2.5 mm<sup>2</sup>
- vgrajena zaščita pred dotikom kontaktov
- antibakterijska zaščita skladna z JIS Z 2801

**SOCKET EURO+KS 2P 10A 250V~ 1M**

- 2P Euro
- 10A 250V~, type VM20
- in accordance with IEC 60884-1, CEE7
- screw contacts 1.5-2.5 mm<sup>2</sup>
- built-in contact protection
- antibacterial protection in accordance with JIS Z 2801



□ KM11AW

**VTIČNICA TV KONČNA 1dB 1M**

- TV končna
- frekvenčni pas 5÷2400 MHz
- dušenje < 1 dB
- ustreza EN 50083-1
- vijajčna priključitev
- antibakterijska zaščita skladna z JIS Z 2801

**SOCKET TV END-LINE 1dB 1M**

- TV end-line
- frequency range 5÷2400 MHz
- reduction < 1 dB
- in accordance with EN 50083-1
- screw contacts
- antibacterial protection in accordance with JIS Z 2801

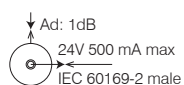

□ KM35AW

**ADAPTER KS 1M**

- KS keystone pritrditveni standard
- AMP, Avaya, Brandrex, FMT, Mfico, Tyco, ...
- komunikacijski modul ni vgrajen
- antibakterijska zaščita skladna z JIS Z 2801

**ADAPTER KS 1M**

- KS keystone fixing standard
- AMP, Avaya, Brandrex, FMT, Mfico, Tyco, ...
- communication module not included
- antibacterial protection in accordance with JIS Z 2801

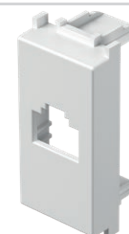

## A N T I B A C T E R I A L P R O G R A M M O D U L



OS20AW

## OKVIR SOFT 2M

- dekorativni okvir SOFT 2M
- ustreza EN 60669-1
- antibakterijska zaščita skladna z JIS Z 2801

## COVER PLATE SOFT 2M

- decorative cover plate SOFT 2M
- in accordance with EN 60669-1
- antibacterial protection in accordance with JIS Z 2801



OS24AW

## OKVIR SOFT 2x2M

- dekorativni okvir SOFT 2x2M
- horizontalna ali vertikalna vgradnja
- ustreza EN 60669-1
- antibakterijska zaščita skladna z JIS Z 2801

## COVER PLATE SOFT 2x2M

- decorative cover plate SOFT 2x2M
- horizontal or vertical mounting
- in accordance with EN 60669-1
- antibacterial protection in accordance with JIS Z 2801



OS26AW

## OKVIR SOFT 3x2M

- dekorativni okvir SOFT 3x2M
- horizontalna ali vertikalna vgradnja
- ustreza EN 60669-1
- antibakterijska zaščita skladna z JIS Z 2801

## COVER PLATE SOFT 3x2M

- decorative cover plate SOFT 3x2M
- horizontal or vertical mounting
- in accordance with EN 60669-1
- antibacterial protection in accordance with JIS Z 2801

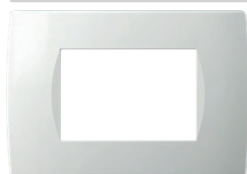

OS30AW

## OKVIR SOFT 3M

- dekorativni okvir SOFT 3M
- ustreza EN 60669-1
- antibakterijska zaščita skladna z JIS Z 2801

## COVER PLATE SOFT 3M

- decorative cover plate SOFT 3M
- in accordance with EN 60669-1
- antibacterial protection in accordance with JIS Z 2801

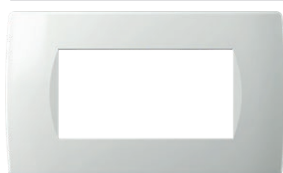

OS40AW

## OKVIR SOFT 4M

- dekorativni okvir SOFT 4M
- ustreza EN 60669-1
- antibakterijska zaščita skladna z JIS Z 2801

## COVER PLATE SOFT 4M

- decorative cover plate SOFT 4M
- in accordance with EN 60669-1
- antibacterial protection in accordance with JIS Z 2801

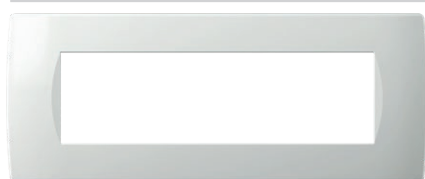

OS70AW

## OKVIR SOFT 7M

- dekorativni okvir SOFT 7M
- ustreza EN 60669-1
- antibakterijska zaščita skladna z JIS Z 2801

## COVER PLATE SOFT 7M

- decorative cover plate SOFT 7M
- in accordance with EN 60669-1
- antibacterial protection in accordance with JIS Z 2801

osnovni  
basic

PW bela-sijaj  
polar white

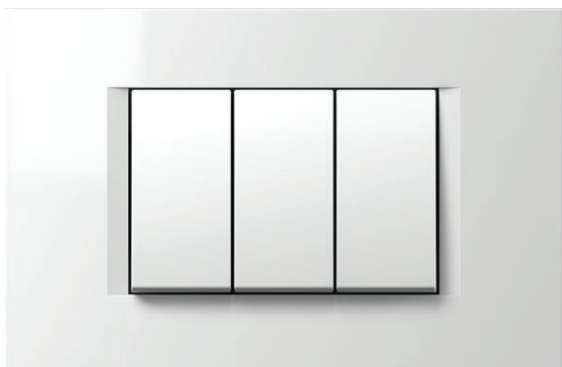

IW bež-sijaj  
ivory white

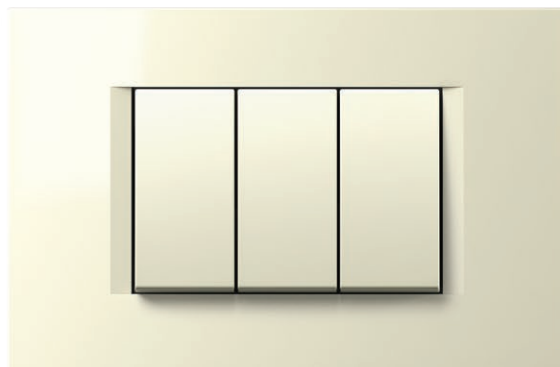

ES srebrna  
elox silver



SB črna-mat  
soft touch black



AT antracit  
anthracite



MW bela-mat  
matte white

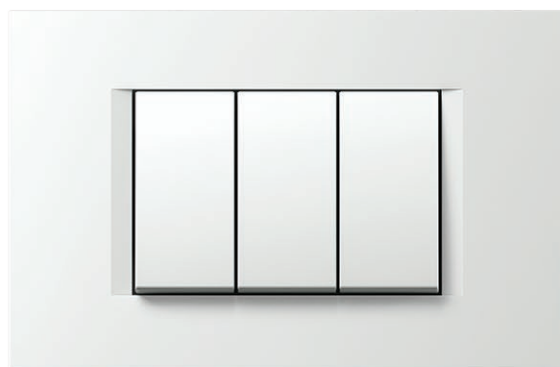



## COVER PLATES LINE OL

dekor  
decor

SG zlata  
sand gold

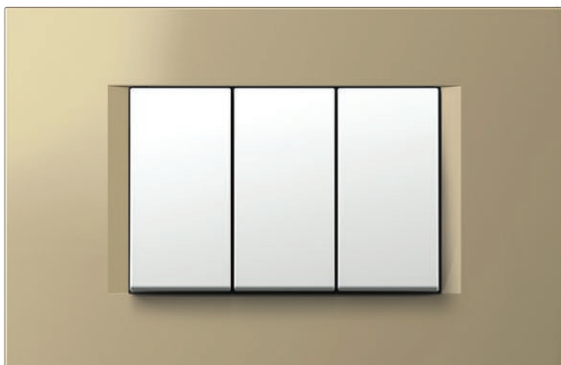

NB črna-sijaj  
night black

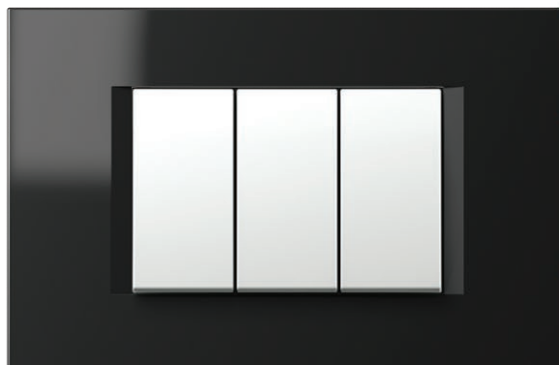

IB modra  
impulse blue



TI titan  
titanium



SW kamen beli  
stone white



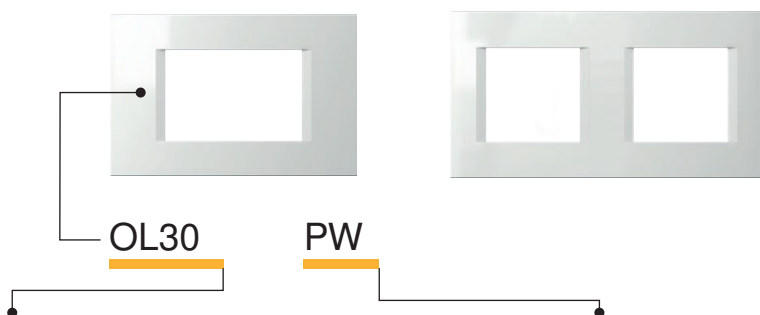

tip type	naziv description	velikost size	barva colour															
OL10	OKVIR LINE COVER PLATE LINE	1/2M	<table border="0"> <tr> <td></td> <td>PW</td> <td>bela-sijaj polar white</td> </tr> <tr> <td></td> <td>SG</td> <td>zlata sand gold</td> </tr> <tr> <td></td> <td>AT</td> <td>antracit anthracite</td> </tr> </table>		PW	bela-sijaj polar white		SG	zlata sand gold		AT	antracit anthracite						
	PW	bela-sijaj polar white																
	SG	zlata sand gold																
	AT	antracit anthracite																
OL13	OKVIR LINE COVER PLATE LINE	1/3M	<table border="0"> <tr> <td></td> <td>MW</td> <td>bela- mat matte white</td> </tr> <tr> <td></td> <td>NB</td> <td>črna-sijaj night black</td> </tr> <tr> <td></td> <td>TI</td> <td>titan titanium</td> </tr> </table>		MW	bela- mat matte white		NB	črna-sijaj night black		TI	titan titanium						
	MW	bela- mat matte white																
	NB	črna-sijaj night black																
	TI	titan titanium																
OL20	OKVIR LINE COVER PLATE LINE	2M	<table border="0"> <tr> <td></td> <td>IW</td> <td>bež-sijaj ivory white</td> </tr> <tr> <td></td> <td>IB</td> <td>modra impulse blue</td> </tr> <tr> <td></td> <td>SW</td> <td>kamen beli stone white</td> </tr> <tr> <td></td> <td>ES</td> <td>srebrna elox silver</td> </tr> <tr> <td></td> <td>SB</td> <td>črna-mat soft touch black</td> </tr> </table>		IW	bež-sijaj ivory white		IB	modra impulse blue		SW	kamen beli stone white		ES	srebrna elox silver		SB	črna-mat soft touch black
	IW	bež-sijaj ivory white																
	IB	modra impulse blue																
	SW	kamen beli stone white																
	ES	srebrna elox silver																
	SB	črna-mat soft touch black																



**OKVIR LINE 1/2M**



	OL10PW		OL10SG
	OL10MW		OL10NB
	OL10IW		OL10IB
	OL10ES		OL10AT
	OL10SB		OL10TI
			OL10SW

- dekorativni okvir LINE 1/2M  
- ustreza EN 60669-1

**COVER PLATE LINE 1/2M**  
- decorative cover plate LINE 1/2M  
- in accordance with EN 60669-1

**OKVIR LINE 2M**

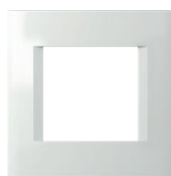

	OL20PW		OL20SG
	OL20MW		OL20NB
	OL20IW		OL20IB
	OL20ES		OL20AT
	OL20SB		OL20TI
			OL20SW

- dekorativni okvir LINE 2M  
- ustreza EN 60669-1

**COVER PLATE LINE 2M**  
- decorative cover plate LINE 2M  
- in accordance with EN 60669-1

**OKVIR LINE 2x2M**

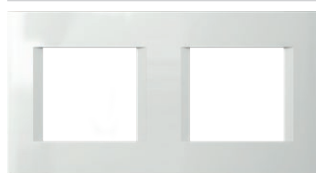

	OL24PW		OL24SG
	OL24MW		OL24NB
	OL24IW		OL24IB
	OL24ES		OL24AT
	OL24SB		OL24TI
			OL24SW

- dekorativni okvir LINE 2x2M  
- horizontalna ali vertikalna vgradnja  
- ustreza EN 60669-1

**COVER PLATE LINE 2x2M**  
- decorative cover plate LINE 2x2M  
- horizontal or vertical mounting  
- in accordance with EN 60669-1

**OKVIR LINE 3x2M**

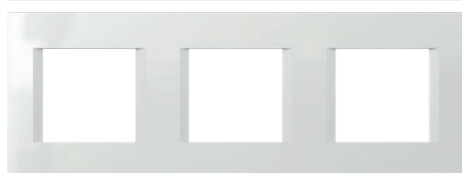

	OL26PW		OL26SG
	OL26MW		OL26NB
	OL26IW		OL26IB
	OL26ES		OL26AT
	OL26SB		OL26TI
			OL26SW

- dekorativni okvir LINE 3x2M  
- horizontalna ali vertikalna vgradnja  
- ustreza EN 60669-1

**COVER PLATE LINE 3x2M**  
- decorative cover plate LINE 3x2M  
- horizontal or vertical mounting  
- in accordance with EN 60669-1

**OKVIR LINE 4x2M**



	OL28PW		OL28SG
	OL28MW		OL28NB
	OL28IW		OL28IB
	OL28ES		OL28AT
	OL28SB		OL28TI
			OL28SW

- dekorativni okvir LINE 4x2M  
- horizontalna ali vertikalna vgradnja  
- ustreza EN 60669-1

**COVER PLATE LINE 4x2M**  
- decorative cover plate LINE 4x2M  
- horizontal or vertical mounting  
- in accordance with EN 60669-1

**OKVIR LINE 5x2M**

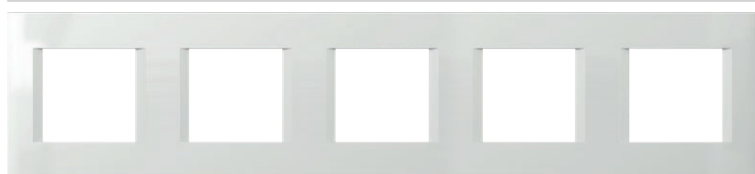









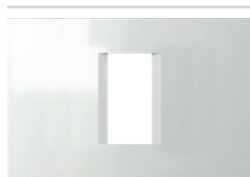



	OL29PW
	OL29MW
	OL29IW
	OL29ES
	OL29SB
	OL29AT
	OL29TI

- dekorativni okvir LINE 5x2M  
- horizontalna ali vertikalna vgradnja  
- ustreza EN 60669-1

**COVER PLATE LINE 5x2M**  
- decorative cover plate LINE 5x2M  
- horizontal or vertical mounting  
- in accordance with EN 60669-1

## COVER PLATES LINE OL



 OL13PW	 OL13SG
 OL13MW	 OL13NB
 OL13IW	 OL13IB
 OL13ES	 OL13AT
 OL13SB	 OL13TI
	 OL13SW









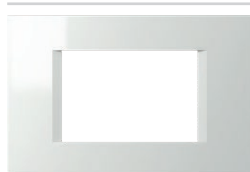

## OKVIR LINE 1/3M

- dekorativni okvir LINE 1/3M  
- ustreza EN 60669-1

## COVER PLATE LINE 1/3M

- decorative cover plate LINE 1/3M  
- in accordance with EN 60669-1



 OL30PW	 OL30SG
 OL30MW	 OL30NB
 OL30IW	 OL30IB
 OL30ES	 OL30AT
 OL30SB	 OL30TI
	 OL30SW









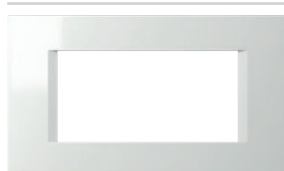

## OKVIR LINE 3M

- dekorativni okvir LINE 3M  
- ustreza EN 60669-1

## COVER PLATE LINE 3M

- decorative cover plate LINE 3M  
- in accordance with EN 60669-1



 OL40PW	 OL40SG
 OL40MW	 OL40NB
 OL40IW	 OL40IB
 OL40ES	 OL40AT
 OL40SB	 OL40TI
	 OL40SW

## OKVIR LINE 4M

- dekorativni okvir LINE 4M  
- ustreza EN 60669-1

## COVER PLATE LINE 4M

- decorative cover plate LINE 4M  
- in accordance with EN 60669-1

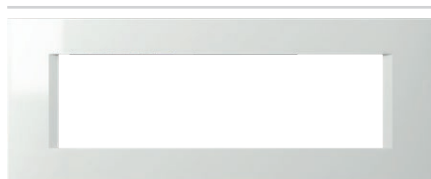

 OL70PW	 OL70SG
 OL70MW	 OL70NB
 OL70IW	 OL70IB
 OL70ES	 OL70AT
 OL70SB	 OL70TI
	 OL70SW







## OKVIR LINE 7M

- dekorativni okvir LINE 7M  
- ustreza EN 60669-1

## COVER PLATE LINE 7M

- decorative cover plate LINE 7M  
- in accordance with EN 60669-1



 OL71PW	 OL71AT
 OL71MW	 OL71TI
 OL71IW	
 OL71ES	
 OL71SB	









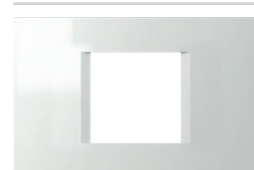

## OKVIR LINE 2x7M

- dekorativni okvir LINE 2x7M  
- ustreza EN 60669-1

## COVER PLATE LINE 2x7M

- decorative cover plate LINE 2x7M  
- in accordance with EN 60669-1



 OL23PW	 OL23SG
 OL23MW	 OL23NB
 OL23IW	 OL23IB
 OL23ES	 OL23AT
 OL23SB	 OL23TI
	 OL23SW

## OKVIR LINE 2/3M

- dekorativni okvir LINE 2/3M  
- ustreza EN 60669-1

## COVER PLATE LINE 2/3M

- decorative cover plate LINE 2/3M  
- in accordance with EN 60669-1

osnovni  
basic

PW bela-sijaj  
polar white

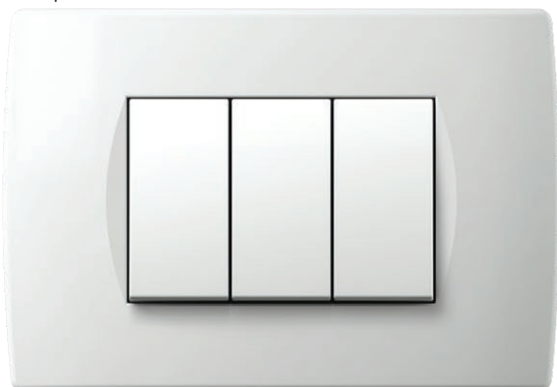

IW bež-sijaj  
ivory white

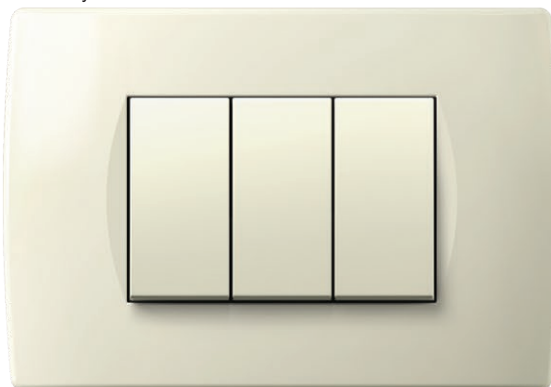

ES srebrna-mat  
elox silver

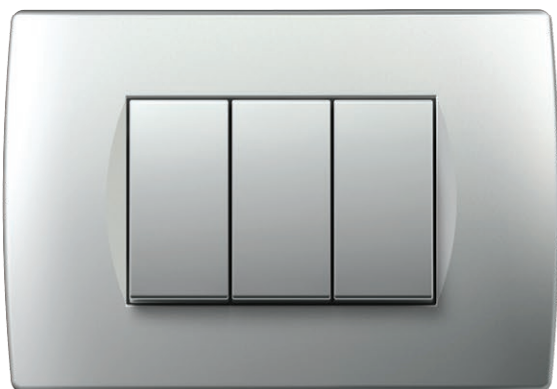

SB črna-mat  
soft touch black

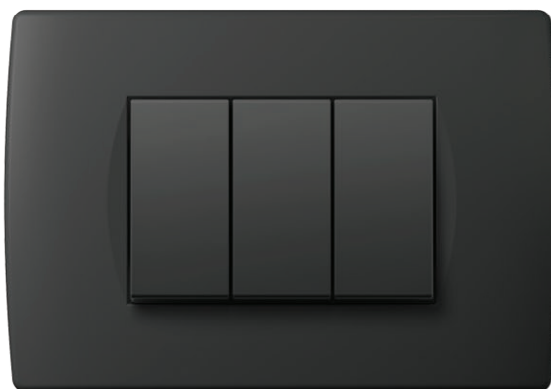

AT antracit  
anthracite



MW bela-mat  
matte white

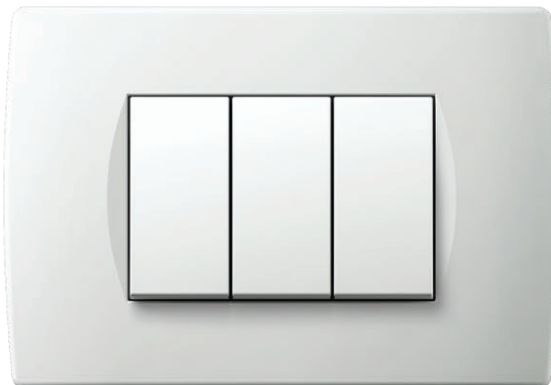

## COVER PLATES SOFT OS

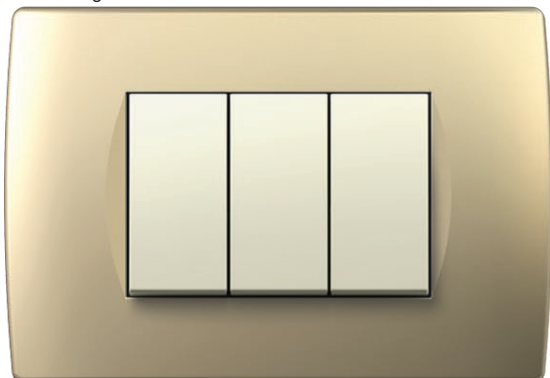
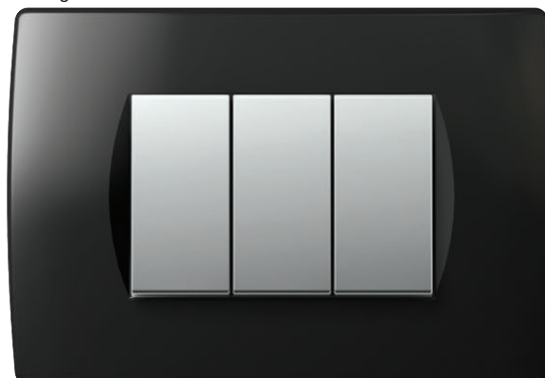
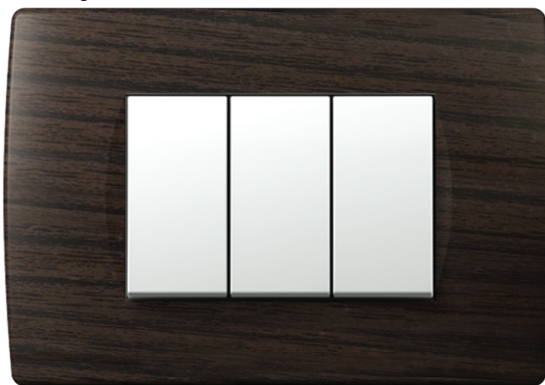
dekor  
decorSG zlata-mat  
sand goldNB črna-sijaj  
night blackTI titan  
titaniumWE wenge  
wengeWW oreh  
walnut



OS30

PW

tip type	naziv description	velikost size	barva colour																														
OS10	OKVIR SOFT COVER PLATE SOFT	1/2M	<table border="0"> <tr> <td></td> <td>PW bela-sijaj polar white</td> <td></td> <td>SG zlata-mat sand gold</td> <td></td> <td>WW oreh walnut</td> </tr> <tr> <td></td> <td>MW bela-mat matte white</td> <td></td> <td>NB črna-sijaj night black</td> <td></td> <td>WE wenge wenge</td> </tr> <tr> <td></td> <td>IW bež-sijaj ivory white</td> <td></td> <td>AT antracit anthracite</td> <td></td> <td></td> </tr> <tr> <td></td> <td>ES srebrna-mat elox silver</td> <td></td> <td>TI titan titanium</td> <td></td> <td></td> </tr> <tr> <td></td> <td>SB črna-mat soft touch black</td> <td></td> <td></td> <td></td> <td></td> </tr> </table>		PW bela-sijaj polar white		SG zlata-mat sand gold		WW oreh walnut		MW bela-mat matte white		NB črna-sijaj night black		WE wenge wenge		IW bež-sijaj ivory white		AT antracit anthracite				ES srebrna-mat elox silver		TI titan titanium				SB črna-mat soft touch black				
	PW bela-sijaj polar white		SG zlata-mat sand gold		WW oreh walnut																												
	MW bela-mat matte white		NB črna-sijaj night black		WE wenge wenge																												
	IW bež-sijaj ivory white		AT antracit anthracite																														
	ES srebrna-mat elox silver		TI titan titanium																														
	SB črna-mat soft touch black																																
OS13	OKVIR SOFT COVER PLATE SOFT	1/3M																															
OS20	OKVIR SOFT COVER PLATE SOFT	2M																															
.	.	.																															
.	.	.																															



#### OKVIR SOFT 1/2M



	OS10PW		OS10SG
	OS10MW		OS10NB
	OS10IW		OS10AT
	OS10ES		OS10TI
	OS10SB		OS10WW
			OS10WE

- dekorativni okvir SOFT 1/2M  
- ustreza EN 60669-1

#### COVER PLATE SOFT 1/2M

- decorative cover plate SOFT 1/2M  
- in accordance with EN 60669-1

#### OKVIR SOFT 2M



	OS20PW		OS20SG
	OS20MW		OS20NB
	OS20IW		OS20AT
	OS20ES		OS20TI
	OS20SB		OS20WW
			OS20WE

- dekorativni okvir SOFT 2M  
- ustreza EN 60669-1

#### COVER PLATE SOFT 2M

- decorative cover plate SOFT 2M  
- in accordance with EN 60669-1

#### OKVIR SOFT 2x2M



	OS24PW		OS24SG
	OS24MW		OS24NB
	OS24IW		OS24AT
	OS24ES		OS24TI
	OS24SB		OS24WW
			OS24WE

- dekorativni okvir SOFT 2x2M  
- horizontalna ali vertikalna vgradnja  
- ustreza EN 60669-1

#### COVER PLATE SOFT 2x2M

- decorative cover plate SOFT 2x2M  
- horizontal or vertical mounting  
- in accordance with EN 60669-1

#### OKVIR SOFT 3x2M



	OS26PW		OS26SG
	OS26MW		OS26NB
	OS26IW		OS26AT
	OS26ES		OS26TI
	OS26SB		OS26WW
			OS26WE

- dekorativni okvir SOFT 3x2M  
- horizontalna ali vertikalna vgradnja  
- ustreza EN 60669-1

#### COVER PLATE SOFT 3x2M

- decorative cover plate SOFT 3x2M  
- horizontal or vertical mounting  
- in accordance with EN 60669-1

#### OKVIR SOFT 4x2M



	OS28PW		OS28SG
	OS28MW		OS28NB
	OS28IW		OS28AT
	OS28ES		OS28TI
	OS28SB		OS28WW
			OS28WE

- dekorativni okvir SOFT 4x2M  
- horizontalna ali vertikalna vgradnja  
- ustreza EN 60669-1

#### COVER PLATE SOFT 4x2M

- decorative cover plate SOFT 4x2M  
- horizontal or vertical mounting  
- in accordance with EN 60669-1

## COVER PLATES SOFT OS

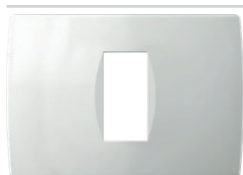

 OS13PW	 OS13SG
 OS13MW	 OS13NB
 OS13IW	 OS13AT
 OS13ES	 OS13TI
 OS13SB	 OS13WW
	 OS13WE









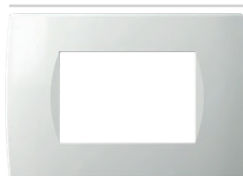

## OKVIR SOFT 1/3M

- dekorativni okvir SOFT 1/3M  
- ustreza EN 60669-1

## COVER PLATE SOFT 1/3M

- decorative cover plate SOFT 1/3M  
- in accordance with EN 60669-1



 OS30PW	 OS30SG
 OS30MW	 OS30NB
 OS30IW	 OS30AT
 OS30ES	 OS30TI
 OS30SB	 OS30WW
	 OS30WE











## OKVIR SOFT 3M

- dekorativni okvir SOFT 3M  
- ustreza EN 60669-1

## COVER PLATE SOFT 3M

- decorative cover plate SOFT 3M  
- in accordance with EN 60669-1



 OS40PW	 OS40SG
 OS40MW	 OS40NB
 OS40IW	 OS40AT
 OS40ES	 OS40TI
 OS40SB	 OS40WW
	 OS40WE



## OKVIR SOFT 4M

- dekorativni okvir SOFT 4M  
- ustreza EN 60669-1

## COVER PLATE SOFT 4M

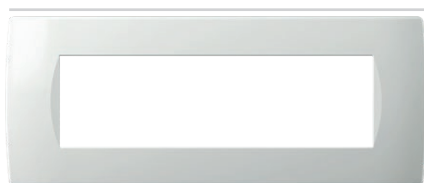
- decorative cover plate SOFT 4M  
- in accordance with EN 60669-1



 OS70PW	 OS70SG
 OS70MW	 OS70NB
 OS70IW	 OS70AT
 OS70ES	 OS70TI
 OS70SB	 OS70WW
	 OS70WE







## OKVIR SOFT 7M

- dekorativni okvir SOFT 7M  
- ustreza EN 60669-1

## COVER PLATE SOFT 7M

- decorative cover plate SOFT 7M  
- in accordance with EN 60669-1



 OS71PW	 OS71AT
 OS71MW	 OS71TI
 OS71IW	
 OS71ES	
 OS71SB	







## OKVIR SOFT 2x7M

- dekorativni okvir SOFT 2x7M  
- ustreza EN 60669-1

## COVER PLATE SOFT 2x7M

- decorative cover plate SOFT 2x7M  
- in accordance with EN 60669-1



 OS72PW	 OS72SG
 OS72IW	 OS72AT
 OS72ES	 OS72TI
 OS72SB	









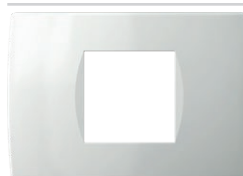

## OKVIR SOFT 2x7M Z NAPISNO PLOŠČICO

- dekorativni okvir SOFT 2x7M z  
napisno ploščico  
- ustreza EN 60669-1

## COVER PLATE SOFT 2x7M

- decorative cover plate SOFT 2x7M  
with inscription plate  
- in accordance with EN 60669-1



 OS23PW	 OS23SG
 OS23MW	 OS23NB
 OS23IW	 OS23AT
 OS23ES	 OS23TI
 OS23SB	 OS23WW
	 OS23WE

## OKVIR SOFT 2/3M

- dekorativni okvir SOFT 2/3M  
- ustreza EN 60669-1

## COVER PLATE SOFT 2/3M

- decorative cover plate SOFT 2/3M  
- in accordance with EN 60669-1

**DEKORACIJE OKVIRJEV**

- pri večjem naročilu naredimo dekorativne okvirje v barvi po vaših željah
- primerno za okvirje OL, OS

*COVER PLATES DECORATIONS*

- when ordering large quantities, cover plates can be made in the colour of your choice
- suitable for cover plates OL, OS

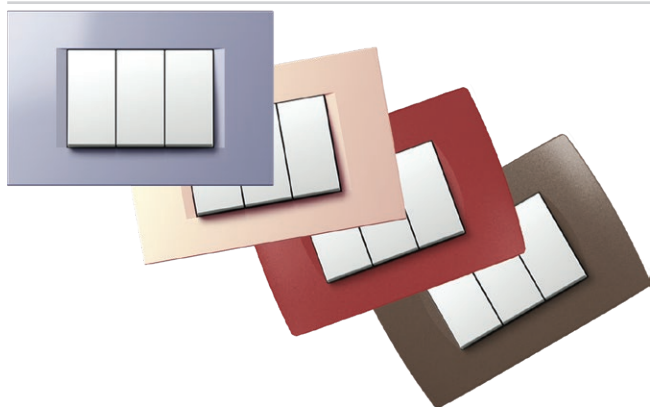





les  
woodWB bambus  
bambooWW oreh  
walnutWM javor  
mapleWE wenge  
wenge

**Narava je edinstvena in dragocena, kot naši okvirji, med katerimi ni enakega.**

*Reklamacij glede različnosti izgleda in medsebojnega razlikovanja pri lesenih okvirjih ne moremo upoštevati.*

**Nature is unique and precious, as our decorative cover plates where no two are the same.**

*Complaints about wooden decorative cover plate's diverse appearance and differentiation cannot be considered.*

MODUL

PURE

## C O V E R P L A T E S P U R E O P

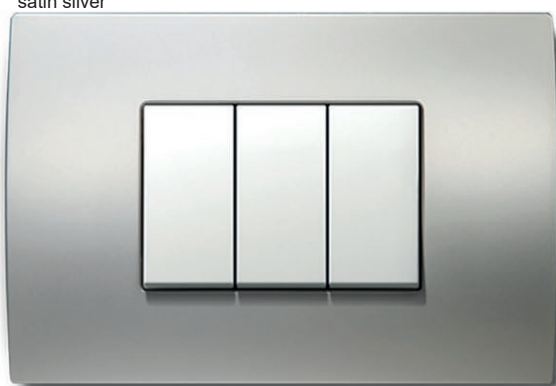
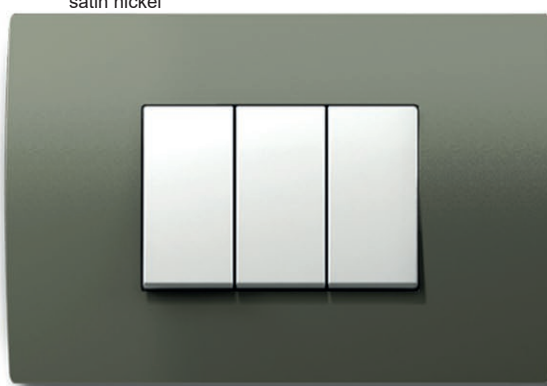
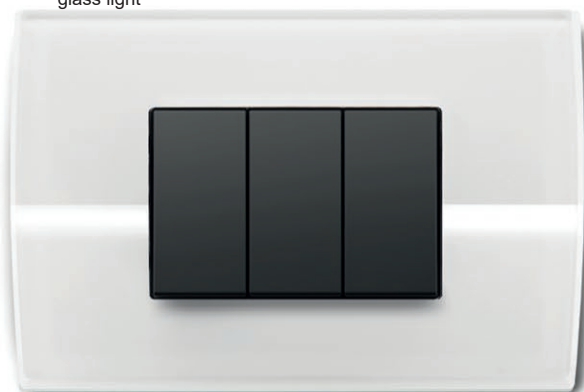
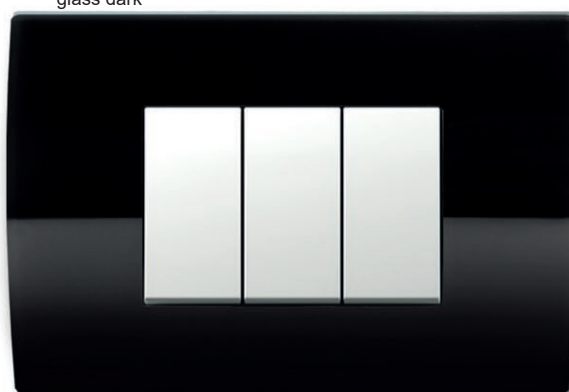
kovina  
metalMH kovano jeklo  
hammered steelME zarjavelo železo  
etched ironMS satinirano srebro  
satin silverMN satiniran nikelj  
satin nickelsteklo  
glassGL bela  
glass lightGD črna  
glass dark



tip type	naziv description	velikost size	barva colour	
OP13	OKVIR PURE COVER PLATE PURE	1/3M	MH kovano jeklo hammered steel	WB bambus bamboo
OP20	OKVIR PURE COVER PLATE PURE	2M	ME zarjavelo železo etched iron	WW oreh walnut
OP23	OKVIR PURE COVER PLATE PURE	2/3M	MS satinirano srebro satin silver	WM javor maple
.	.	.	MN satiniran nikelj satin nickel	WE wenge wenge
.	.	.		GL bela glass light
.	.	.		GD črna glass dark



OP20MH	OP20WB
OP20ME	OP20WW
OP20MS	OP20WM
OP20MN	OP20WE
	OP20GL
	OP20GD

#### OKVIR PURE 2M

- dekorativni okvir PURE 2M  
- ustreza EN 60669-1

#### COVER PLATE PURE 2M

- decorative cover plate PURE 2M  
- in accordance with EN 60669-1

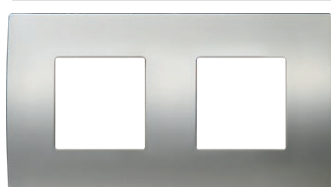

OP24MH	OP24WB
OP24ME	OP24WW
OP24MS	OP24WM
OP24MN	OP24WE
	OP24GL
	OP24GD

#### OKVIR PURE 2x2M

- dekorativni okvir PURE 2x2M  
- horizontalna ali vertikalna vgradnja  
- ustreza EN 60669-1

#### COVER PLATE PURE 2x2M

- decorative cover plate PURE 2x2M  
- horizontal or vertical mounting  
- in accordance with EN 60669-1

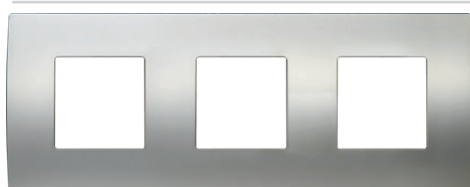

OP26MH	OP26WB
OP26ME	OP26WW
OP26MS	OP26WM
OP26MN	OP26WE
	OP26GL
	OP26GD

#### OKVIR PURE 3x2M

- dekorativni okvir PURE 3x2M  
- horizontalna ali vertikalna vgradnja  
- ustreza EN 60669-1

#### COVER PLATE PURE 3x2M

- decorative cover plate PURE 3x2M  
- horizontal or vertical mounting  
- in accordance with EN 60669-1



OP28MH	OP28WB
OP28ME	OP28WW
OP28MS	OP28WM
OP28MN	OP28WE
	OP28GL
	OP28GD

#### OKVIR PURE 4x2M

- dekorativni okvir PURE 4x2M  
- horizontalna ali vertikalna vgradnja  
- ustreza EN 60669-1

#### COVER PLATE PURE 4x2M

- decorative cover plate PURE 4x2M  
- horizontal or vertical mounting  
- in accordance with EN 60669-1

## COVER PLATES PURE OP

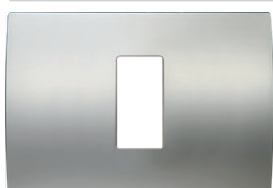

	OP13MH		OP13WB
	OP13ME		OP13WW
	OP13MS		OP13WM
	OP13MN		OP13WE
			OP13GL
			OP13GD

## OKVIR PURE 1/3M

- dekorativni okvir PURE 1/3M  
- ustreza EN 60669-1

## COVER PLATE PURE 1/3M

- decorative cover plate PURE 1/3M  
- in accordance with EN 60669-1

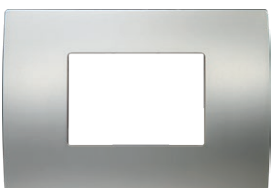

	OP30MH		OP30WB
	OP30ME		OP30WW
	OP30MS		OP30WM
	OP30MN		OP30WE
			OP30GL
			OP30GD

## OKVIR PURE 3M

- dekorativni okvir PURE 3M  
- ustreza EN 60669-1

## COVER PLATE PURE 3M

- decorative cover plate PURE 3M  
- in accordance with EN 60669-1

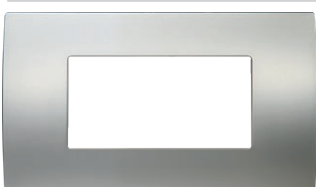

	OP40MH		OP40WB
	OP40ME		OP40WW
	OP40MS		OP40WM
	OP40MN		OP40WE
			OP40GL
			OP40GD

## OKVIR PURE 4M

- dekorativni okvir PURE 4M  
- ustreza EN 60669-1

## COVER PLATE PURE 4M

- decorative cover plate PURE 4M  
- in accordance with EN 60669-1

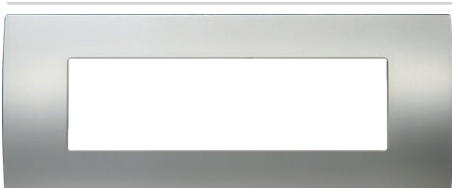

	OP70MH		OP70WB
	OP70ME		OP70WW
	OP70MS		OP70WM
	OP70MN		OP70WE
			OP70GL
			OP70GD

## OKVIR PURE 7M

- dekorativni okvir PURE 7M  
- ustreza EN 60669-1

## COVER PLATE PURE 7M

- decorative cover plate PURE 7M  
- in accordance with EN 60669-1

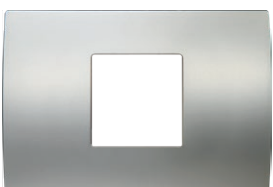

	OP23MH		OP23WB
	OP23ME		OP23WW
	OP23MS		OP23WM
	OP23MN		OP23WE
			OP23GL
			OP23GD

## OKVIR PURE 2/3M

- dekorativni okvir PURE 2/3M  
- ustreza EN 60669-1

## COVER PLATE PURE 2/3M

- decorative cover plate PURE 2/3M  
- in accordance with EN 60669-1

Be bold, be EDGE

## C O V E R P L A T E S E D G E O G

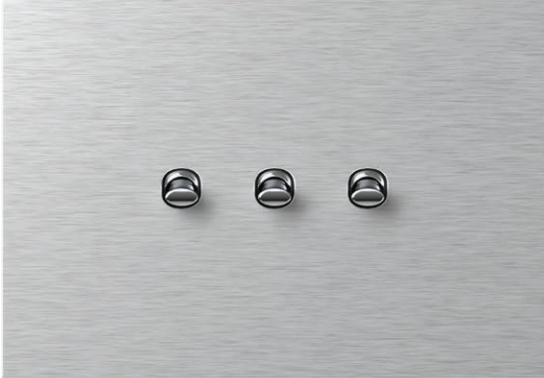
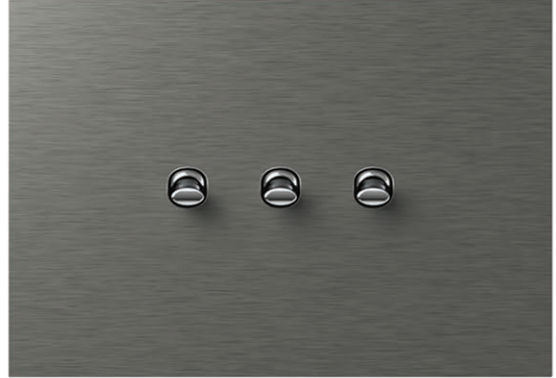
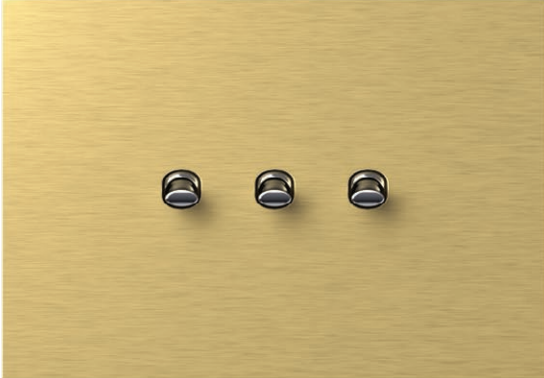
kovina  
metalMA srebrna  
silverMT antracit  
anthraciteMZ zlata  
goldsteklo  
glassGD črna  
glass darkGL bela  
glass light

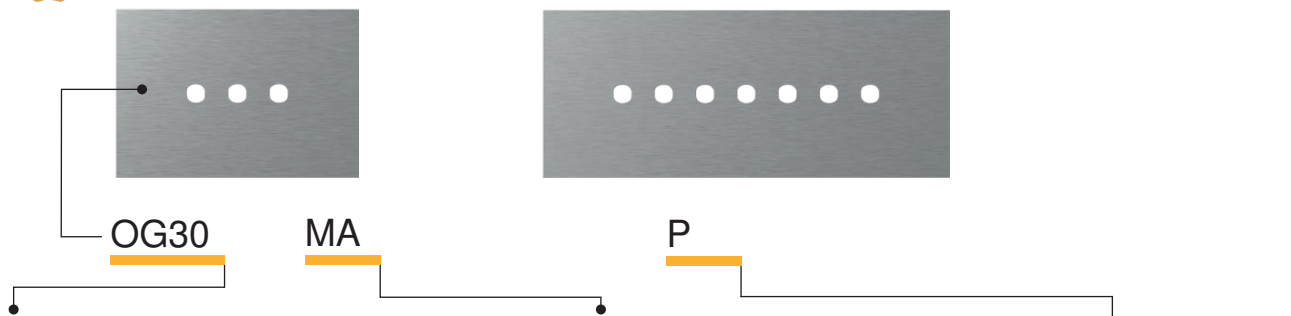

tip type	naziv description	velikost size	barva colour
OG10	OKVIR EDGE COVER PLATE EDGE	1/2M	MA srebrna silver
OG13	OKVIR EDGE COVER PLATE EDGE	1/3M	MT antracit anthracite
OG20	OKVIR EDGE COVER PLATE EDGE	2M	MZ zlata gold
...	...	...	...

barva colour	GD	GL
črna dark	črna dark	bela light

tip	oznaka
P	...
M	□

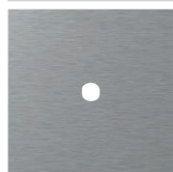

- OG10MAP
- OG10MTP
- OG10MZP
- OG10GDP
- OG10GLP

**OKVIR EDGE 1/2M**

- dekorativni okvir EDGE 1/2M  
- ustreza EN 60669-1

**COVER PLATE EDGE 1/2M**

- decorative cover plate EDGE 1/2M  
- in accordance with EN 60669-1

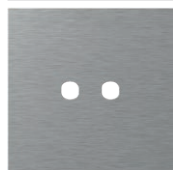

- OG20MAP
- OG20MTP
- OG20MZP
- OG20GDP
- OG20GLP

**OKVIR EDGE 2M**

- dekorativni okvir EDGE 2M  
- ustreza EN 60669-1

**COVER PLATE EDGE 2M**

- decorative cover plate EDGE 2M  
- in accordance with EN 60669-1



## C O V E R P L A T E S E D G E O G

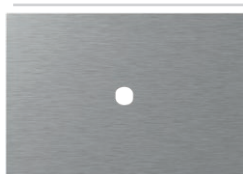

## OKVIR EDGE 1/3M

- dekorativni okvir EDGE 1/3M  
- ustreza EN 60669-1

*COVER PLATE EDGE 1/3M*

- decorative cover plate EDGE 1/3M  
- in accordance with EN 60669-1

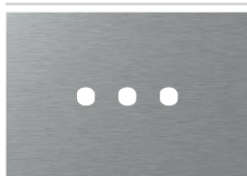

## OKVIR EDGE 3M

- dekorativni okvir EDGE 3M  
- ustreza EN 60669-1

*COVER PLATE EDGE 3M*

- decorative cover plate EDGE 3M  
- in accordance with EN 60669-1

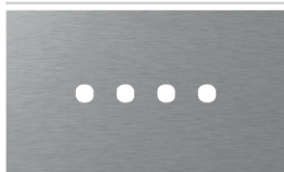

## OKVIR EDGE 4M

- dekorativni okvir EDGE 4M  
- ustreza EN 60669-1

*COVER PLATE EDGE 4M*

- decorative cover plate EDGE 4M  
- in accordance with EN 60669-1

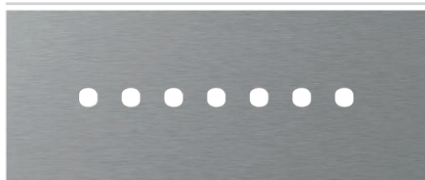

## OKVIR EDGE 7M

- dekorativni okvir EDGE 7M  
- ustreza EN 60669-1

*COVER PLATE EDGE 7M*

- decorative cover plate EDGE 7M  
- in accordance with EN 60669-1

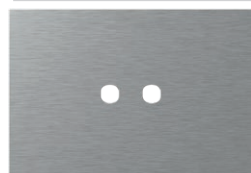

## OKVIR EDGE 2/3M

- dekorativni okvir EDGE 2/3M  
- ustreza EN 60669-1

## OKVIR EDGE 2/3M

- dekorativni okvir EDGE 2/3M  
- usklađeno s normom EN 60669-1

kovina  
metal

MA srebrna  
silver

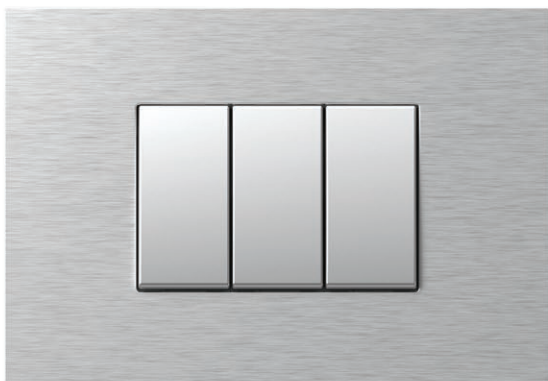

MT antracit  
anthracite



MZ zlata  
gold

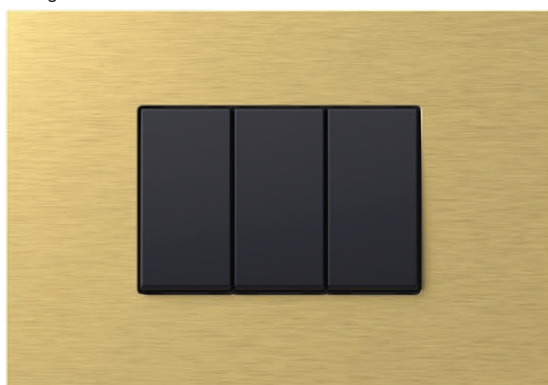

steklo  
glass

GD črna  
glass dark

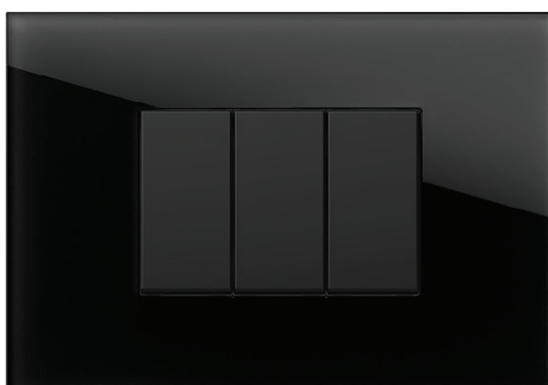

GL bela  
glas light

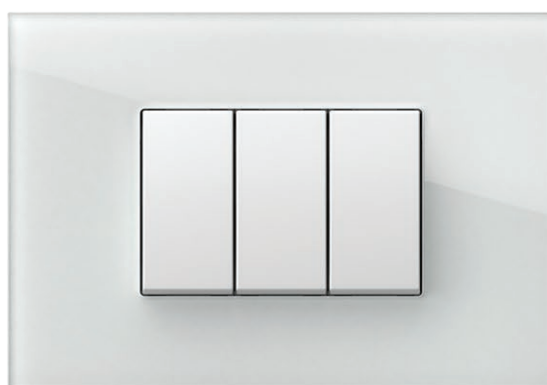

## COVER PLATES EDGE OG



OG30

MA

M

tip type	naziv description	velikost size	barva colour
OG10	OKVIR EDGE COVER PLATE EDGE	1/2M	MA srebrna silver GD črna glass dark
OG13	OKVIR EDGE COVER PLATE EDGE	1/3M	MT antracit anthracite GL bela glass light
OG20	OKVIR EDGE COVER PLATE EDGE	2M	MZ zlata gold
...	...	...	...

M



P

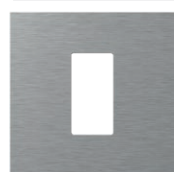

OG10MAM  
OG10MTM  
OG10MZM

OG10GDM  
OG10GLM

## OKVIR EDGE 1/2M

- dekorativni okvir EDGE 1/2M  
- ustreza EN 60669-1

## COVER PLATE EDGE 1/2M

- decorative cover plate EDGE 1/2M  
- in accordance with EN 60669-1

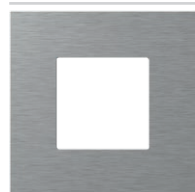

OG20MAM  
OG20MTM  
OG20MZM

OG20GDM  
OG20GLM

## OKVIR EDGE 2M

- dekorativni okvir EDGE 2M  
- ustreza EN 60669-1

## COVER PLATE EDGE 2M

- decorative cover plate EDGE 2M  
- in accordance with EN 60669-1



OG24MAM  
OG24MTM  
OG24MZM

OG24GDM  
OG24GLM

## OKVIR EDGE 2x2M

- dekorativni okvir EDGE 2x2M  
- horizontalna ali vertikalna vgradnja  
- ustreza EN 60669-1

## COVER PLATE EDGE 2x2M

- decorative cover plate EDGE 2x2M  
- horizontal or vertical mounting  
- in accordance with EN 60669-1

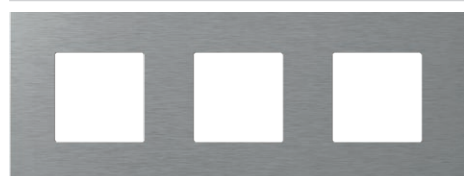

OG26MAM  
OG26MTM  
OG26MZM

OG26GDM  
OG26GLM

## OKVIR EDGE 3x2M

- dekorativni okvir EDGE 3x2M  
- horizontalna ali vertikalna vgradnja  
- ustreza EN 60669-1

## COVER PLATE EDGE 3x2M

- decorative cover plate EDGE 3x2M  
- horizontal or vertical mounting  
- in accordance with EN 60669-1

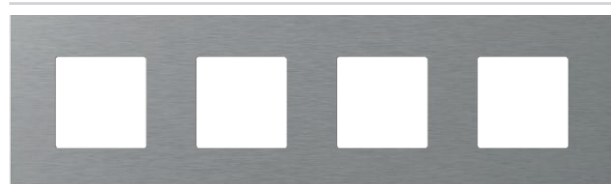

OG28MAM  
OG28MTM  
OG28MZM

OG28GDM  
OG28GLM



## OKVIR EDGE 4x2M

- dekorativni okvir EDGE 4x2M  
- horizontalna ali vertikalna vgradnja  
- ustreza EN 60669-1

## COVER PLATE EDGE 4x2M

- decorative cover plate EDGE 4x2M  
- horizontal or vertical mounting  
- in accordance with EN 60669-1



- |   |   |
|---|---|
|  OG13MAM |  OG13GDM |
|  OG13MTM |  OG13GLM |
|  OG13MZM |   |

**OKVIR EDGE 1/3M**

- dekorativni okvir EDGE 1/3M  
- ustreza EN 60669-1

*COVER PLATE EDGE 1/3M*

- decorative cover plate EDGE 1/3M  
- in accordance with EN 60669-1



- |   |   |
|---|---|
|  OG30MAM |  OG30GDM |
|  OG30MTM |  OG30GLM |
|  OG30MZM |   |

**OKVIR EDGE 3M**

- dekorativni okvir EDGE 3M  
- ustreza EN 60669-1

*COVER PLATE EDGE 3M*

- decorative cover plate EDGE 3M  
- in accordance with EN 60669-1



- |   |   |
|---|---|
|  OG40MAM |  OG40GDM |
|  OG40MTM |  OG40GLM |
|  OG40MZM |   |

**OKVIR EDGE 4M**

- dekorativni okvir EDGE 4M  
- ustreza EN 60669-1

*COVER PLATE EDGE 4M*

- decorative cover plate EDGE 4M  
- in accordance with EN 60669-1



- |   |   |
|---|---|
|  OG70MAM |  OG70GDM |
|  OG70MTM |  OG70GLM |
|  OG70MZM |   |





**OKVIR EDGE 7M**

- dekorativni okvir EDGE 7M  
- ustreza EN 60669-1

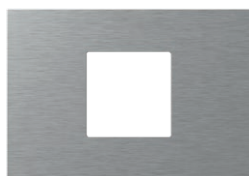
*COVER PLATE EDGE 7M*

- decorative cover plate EDGE 7M  
- in accordance with EN 60669-1



- |   |   |
|---|---|
|  OG23MAM |  OG23GDM |
|  OG23MTM |  OG23GLM |
|  OG23MZM |   |

**OKVIR EDGE 2/3M**

- dekorativni okvir EDGE 2/3M  
- ustreza EN 60669-1

*COVER PLATE EDGE 2/3M*

- decorative cover plate EDGE 2/3M  
- in accordance with EN 60669-1





MODUL  
LINE

A x B



MODUL  
SOFT

A x B



MODUL  
PURE

A x B

1/2M

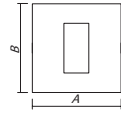

80 x 80 mm

84 x 84 mm

2M

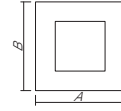

80 x 80 mm

84 x 84 mm

93 x 90 mm

2x2M

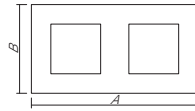

151 x 80 mm

155 x 84 mm

164 x 90 mm

3x2M

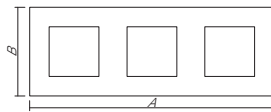

222 x 80 mm

226 x 84 mm

235 x 90 mm

4x2M

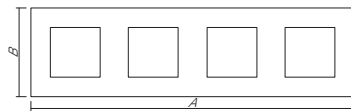

293 x 80 mm

297 x 84 mm

304 x 90 mm

5x2M

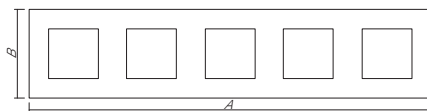

364,1 x 80 mm



1/3M

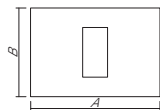

122 x 80 mm

122 x 84 mm

134 x 90 mm

3M

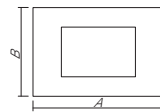

122 x 80 mm

122 x 84 mm

134 x 90 mm

4M

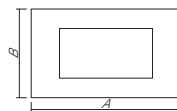

149 x 80 mm

144 x 84 mm

157 x 90 mm

7M

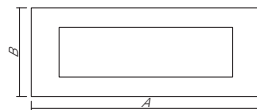

207 x 80 mm

212 x 84 mm

224 x 90 mm

2x7M

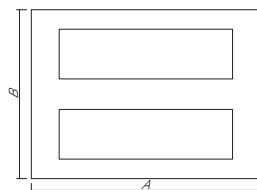

215 x 159 mm

212 x 158 mm



2/3M

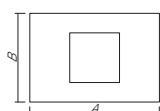

122 x 80 mm

122 x 84 mm

134 x 90 mm



MODUL  
EDGE



		$A \times B$
1/2M		92 x 92 mm
2M		92 x 92 mm
2x2M		163 x 92 mm
3x2M		234 x 92 mm
4x2M		305 x 92 mm



1/3M		132 x 92 mm
3M		132 x 92 mm
4M		154 x 92 mm
7M		222 x 92 mm



2/3M		132 x 92 mm
------	--	-------------

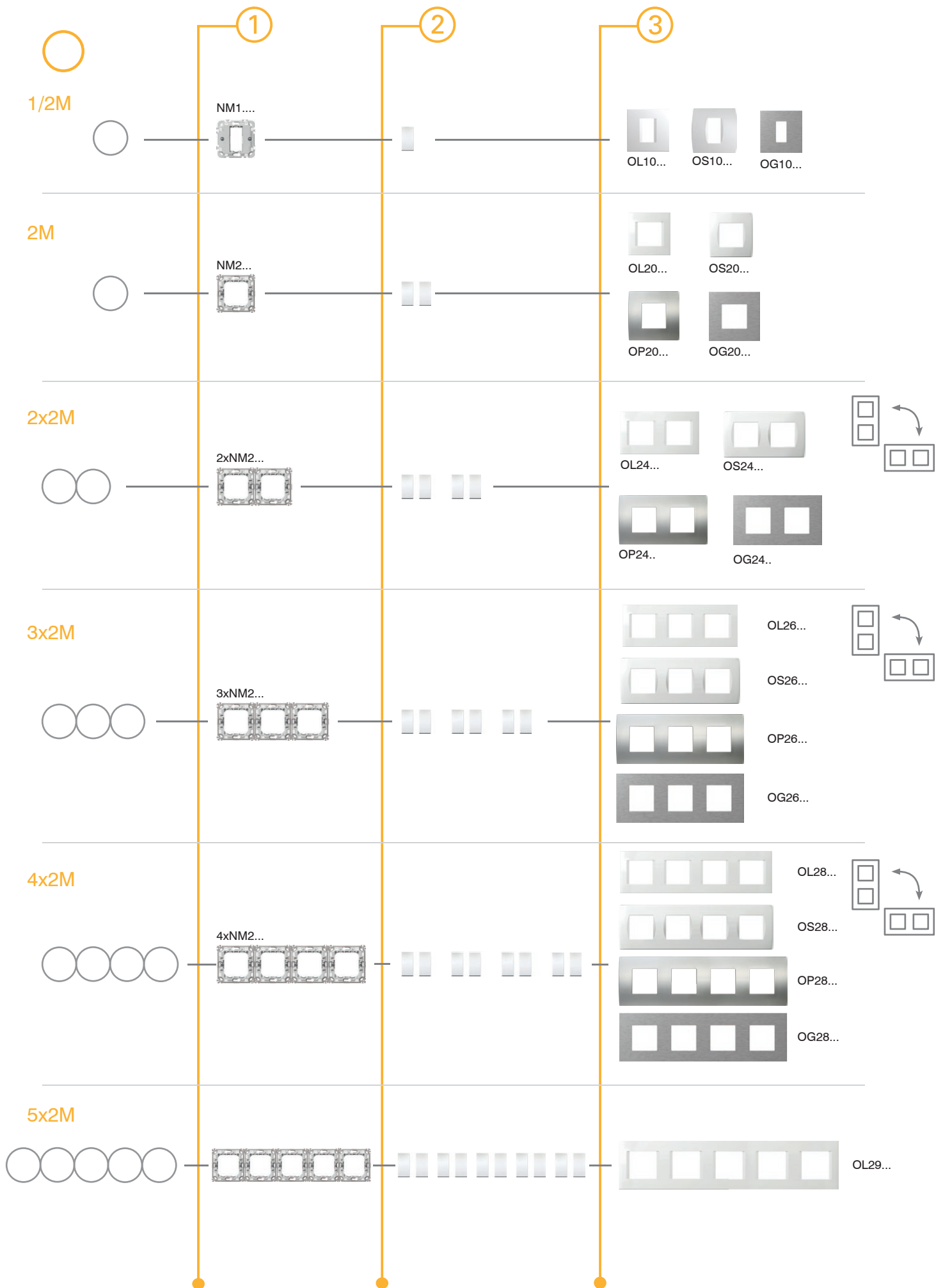



C O M B I N A T I O N S

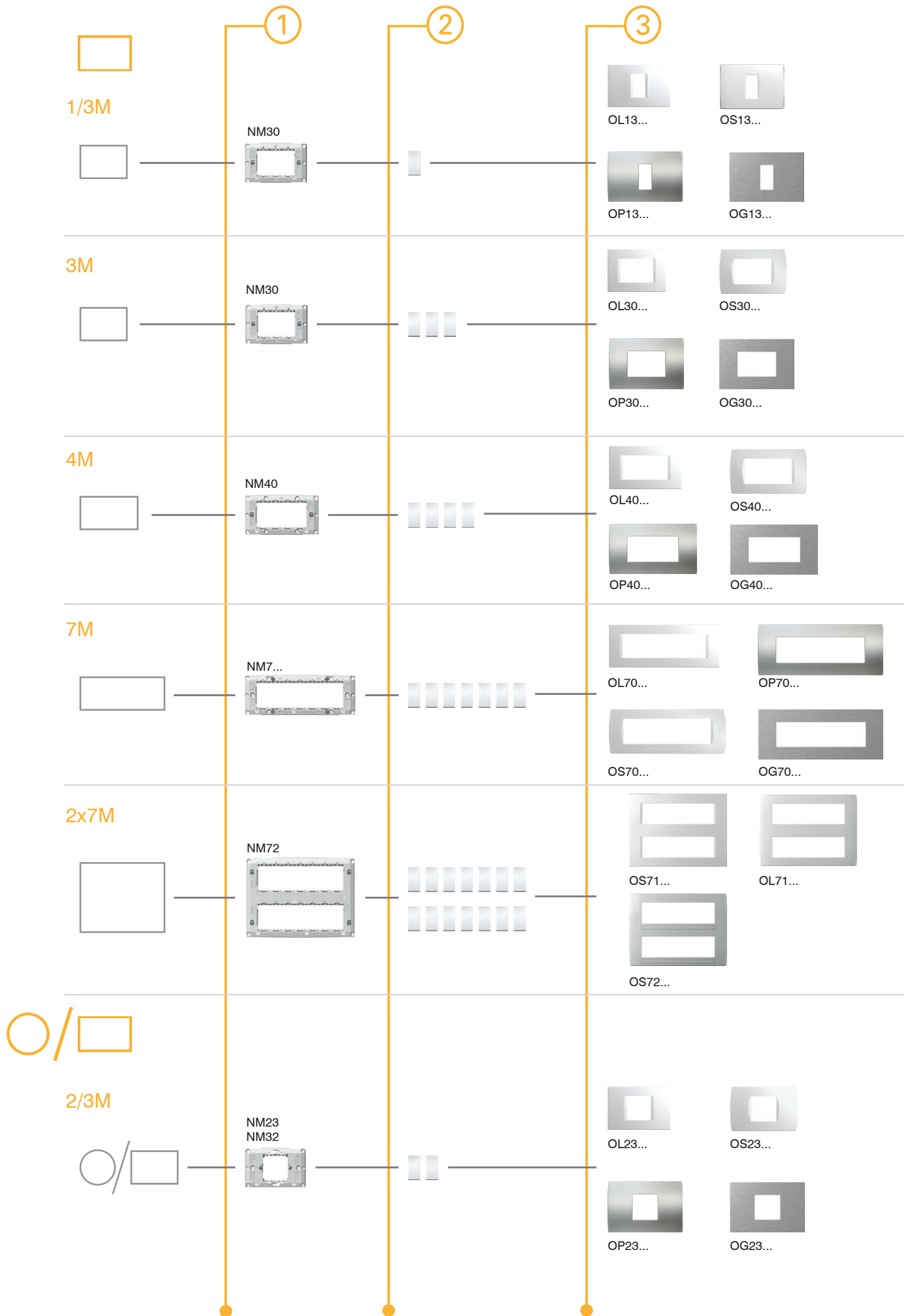

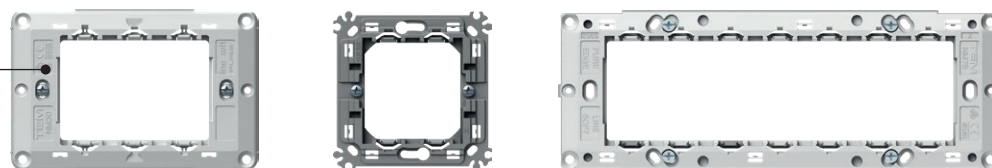

NM30

tip type	naziv description	velikost size
NM10	NOSILEC S KREPELJCI MOUNTING FRAME WITH CLAWS	1/2M
NM11	NOSILEC BREZ VIJAKOV MOUNTING FRAME WITHOUT SCREWS	1/2M
NM20	NOSILEC S KREPELJCI MOUNTING FRAME WITH CLAWS	2M
...	...	...



NOSILEC S KREPELJCI 1/2M

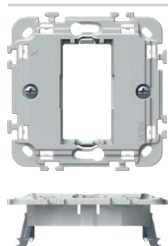

NM10

- nosilec 1/2M s krepeljci
- montaža v doze Ø60 (DE..) s krepeljci
- primeren za sestavo z okvirji LINE, SOFT in EDGE
- ustreza EN 60669-1

*MOUNTING FRAME WITH CLAWS 1/2M*

- mounting frame 1/2M with claws
- for mounting on boxes Ø60 (DE..) with claws
- suitable for assembling with cover plates LINE, SOFT and EDGE
- in accordance with EN 60669-1

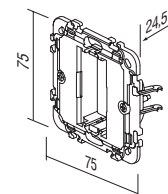

NOSILEC BREZ VIJAKOV 1/2M

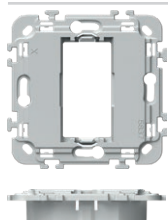

NM11

- nosilec 1/2M brez vijakov in brez krepeljev
- montaža v doze Ø60 (HE.., BE..) z vijaki
- primeren za sestavo z okvirji LINE, SOFT in EDGE
- ustreza EN 60669-1

*MOUNTING FRAME WITHOUT SCREWS 1/2M*

- mounting frame 1/2M without screws and without claws
- for mounting on boxes Ø60 (HE.., BE..) with screws
- suitable for assembling with cover plates LINE, SOFT and EDGE
- in accordance with EN 60669-1

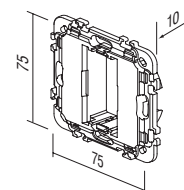

NOSILEC S KREPELJCI 2M

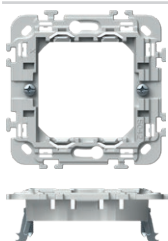

NM20

- nosilec 2M s krepeljci
- montaža v doze Ø60 (DE..) s krepeljci
- možno horizontalno ali vertikalno nizanje 2x2M, 3x2M in 4x2M
- primeren za sestavo z okvirji LINE, SOFT, PURE in EDGE
- ustreza EN 60669-1

*MOUNTING FRAME WITH CLAWS 2M*

- mounting frame 2M with claws
- for mounting on boxes Ø60 (DE..) with claws
- possible horizontal or vertical combinations 2x2M, 3x2M and 4x2M
- suitable for assembling with cover plates LINE, SOFT, PURE and EDGE
- in accordance with EN 60669-1

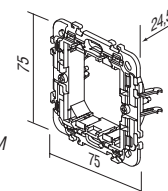

NOSILEC BREZ VIJAKOV 2M

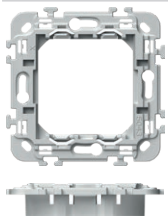

NM21

- nosilec 2M brez vijakov in brez krepeljev
- montaža v doze Ø60 (HE.., BE..) z vijaki
- možno horizontalno ali vertikalno nizanje 2x2M, 3x2M in 4x2M
- primeren za sestavo z okvirji LINE, SOFT, PURE in EDGE
- ustreza EN 60669-1

*MOUNTING FRAME WITHOUT SCREWS 2M*

- mounting frame 2M without screws and without claws
- for mounting on boxes Ø60 (HE.., BE..) with screws
- possible horizontal or vertical combinations 2x2M, 3x2M and 4x2M
- suitable for assembling with cover plates LINE, SOFT, PURE and EDGE
- in accordance with EN 60669-1

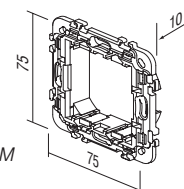

## M O U N T I N G F R A M E S N M

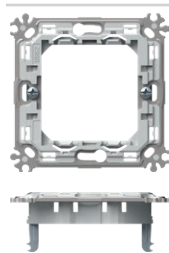

NM24

## NOSILEC KOVINSKI S KREMPELJCI 2M

- kovinski nosilec 2M s krempeljci - toga izvedba
- montaža v doze Ø60 (DE..) s krempeljci
- možno horizontalno ali vertikalno nizanje 2x2M, 3x2M in 4x2M
- primeren za sestavo z okvirji LINE, SOFT, PURE in EDGE
- ustreza EN 60669-1

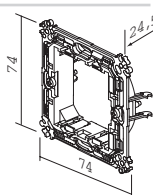

## MOUNTING FRAME METAL WITH CLAWS 2M

- metal mounting frame 2M with claws - stiff version
- for mounting on boxes Ø60 (DE..) with claws
- possible horizontal or vertical combinations 2x2M, 3x2M and 4x2M
- suitable for assembling with cover plates LINE, SOFT, PURE and EDGE
- in accordance with EN 60669-1

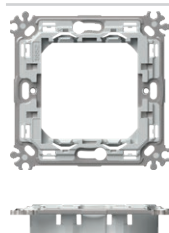

NM25

## NOSILEC KOVINSKI BREZ VIJAKOV 2M

- kovinski nosilec brez vijakov in brez krempeljcev - toga izvedba
- montaža v doze Ø60 (HE..., BE...) z vijaki
- možno horizontalno ali vertikalno nizanje 2x2M, 3x2M in 4x2M
- primeren za sestavo z okvirji LINE, SOFT, PURE in EDGE
- ustreza EN 60669-1

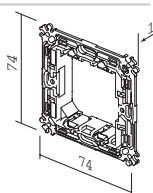

## MOUNTING FRAME METAL WITHOUT SCREWS 2M

- metal mounting frame 2M without screws and without claws - stiff version
- for mounting in boxes Ø60 (HE..., BE...) with screws
- possible horizontal or vertical combinations 2x2M, 3x2M and 4x2M
- suitable for assembling with cover plates LINE, SOFT, PURE and EDGE
- in accordance with EN 60669-1

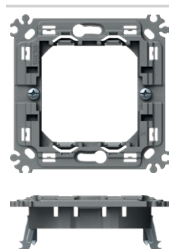

NM26

## NOSILEC OJAČEN S KREMPELJCI 2M

- ojačen nosilec 2M s krempeljci - toga izvedba
- montaža v doze Ø60 (DE..) s krempeljci
- možno horizontalno ali vertikalno nizanje 2x2M, 3x2M in 4x2M
- primeren za sestavo z okvirji LINE, SOFT, PURE in EDGE
- ustreza EN 60669-1

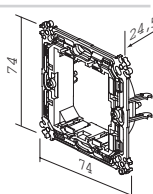

## CLAW REINFORCED MOUNTING FRAME 2M

- 2M mounting frame reinforced with claws - stiff version
- for mounting on boxes Ø60 (DE..) with claws
- possible horizontal or vertical combinations 2x2M, 3x2M and 4x2M
- suitable for assembling with cover plates LINE, SOFT, PURE and EDGE
- in accordance with EN 60669-1

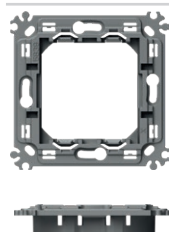

NM27

## NOSILEC OJAČEN BREZ VIJAKOV 2M

- ojačen nosilec brez vijakov in brez krempeljcev - toga izvedba
- montaža v doze Ø60 (HE..., BE...) z vijaki
- možno horizontalno ali vertikalno nizanje 2x2M, 3x2M in 4x2M
- primeren za sestavo z okvirji LINE, SOFT, PURE in EDGE
- ustreza EN 60669-1

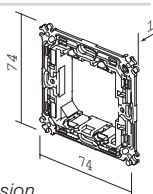

## REINFORCED MOUNTING FRAME WITHOUT SCREWS 2M

- reinforced mounting frame without screws or claws - stiff version
- for mounting in boxes Ø60 (HE..., BE...) with screws
- possible horizontal or vertical combinations 2x2M, 3x2M and 4x2M
- suitable for assembling with cover plates LINE, SOFT, PURE and EDGE
- in accordance with EN 60669-1

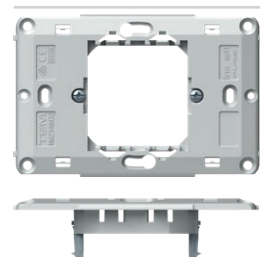

NM23

## NOSILEC S KREMPELJCI 2/3M

- nosilec 2/3M s krempeljci
- montaža v doze Ø60 (DE..) s krempeljci
- primeren za sestavo z okvirji LINE, SOFT, PURE in EDGE
- ustreza EN 60669-1

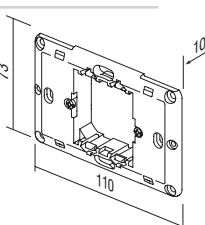

## MOUNTING FRAME WITH CLAWS 2/3M

- mounting frame 2/3M with claws
- for mounting on boxes Ø60 (DE..) with claws
- suitable for assembling with cover plates LINE, SOFT, PURE and EDGE
- in accordance with EN 60669-1





### NOSILEC Z VIJAKI 3M

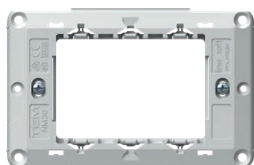

NM30

- nosilec 3M z vijaki
- montaža v pravokotne doze velikosti 3M
- primeren za sestavo z okvirji LINE, SOFT, PURE in EDGE
- ustreza EN 60669-1

#### MOUNTING FRAME WITH SCREWS 3M

- mounting frame 3M with screws
- for mounting on rectangular boxes 3M
- suitable for assembling with cover plates LINE, SOFT, PURE and EDGE
- in accordance with EN 60669-1

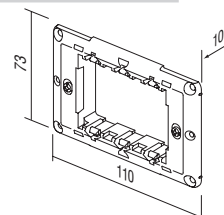

### NOSILEC Z VIJAKI 4M



NM40

- nosilec 4M z vijaki
- montaža v pravokotne doze velikosti 4M
- primeren za sestavo z okvirji LINE, SOFT, PURE in EDGE
- ustreza EN 60669-1

#### MOUNTING FRAME WITH SCREWS 4M

- mounting frame 4M with screws
- for mounting on rectangular boxes 4M
- suitable for assembling with cover plates LINE, SOFT, PURE and EDGE
- in accordance with EN 60669-1

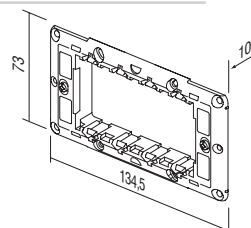

### NOSILEC Z VIJAKI 7M



NM70

- nosilec 7M z vijaki
- montaža v pravokotne doze velikosti 7M
- primeren za sestavo z okvirji 7M
- ustreza EN 60669-1

#### MOUNTING FRAME WITH SCREWS 7M

- mounting frame 7M with screws
- for mounting on rectangular boxes 7M
- suitable for assembling with cover plates 7M
- in accordance with EN 60669-1

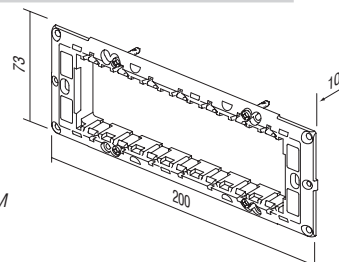

### NOSILEC OJAČEN Z VIJAKI 7M

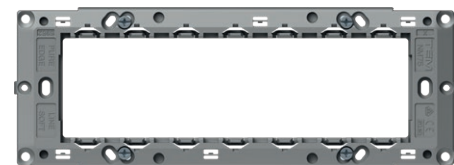

NM75

- ojačen nosilec 7M z vijaki – toga izvedba
- montaža v pravokotne doze velikosti 7M
- primeren za sestavo z okvirji 7M
- ustreza EN 60669-1

#### REINFORCED MOUNTING FRAME WITH SCREWS 7M

- reinforced mounting frame 7M with screws – stiff version
- for mounting on rectangular boxes 7M
- suitable for assembling with cover plates 7M
- in accordance with EN 60669-1

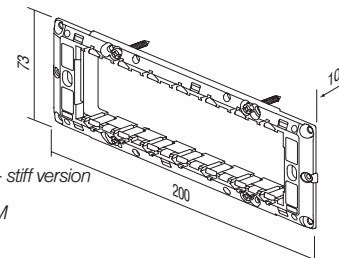

### NOSILEC Z VIJAKI 2x7M

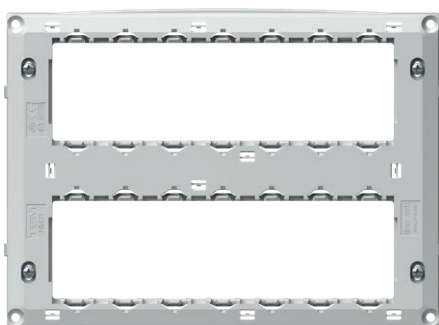

NM72

- nosilec 2x7M z vijaki
- montaža v pravokotne doze velikosti 2x7M
- primeren za sestavo z okvirji 2x7M
- ustreza EN 60669-1

#### MOUNTING FRAME WITH SCREWS 2x7M

- mounting frame 2x7M with screws
- for mounting on rectangular boxes 2x7M
- suitable for assembling with cover plates 2x7M
- in accordance with EN 60669-1

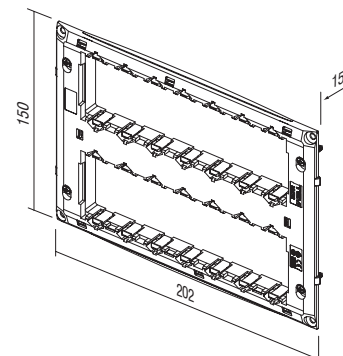

## M O U N T I N G F R A M E S N M

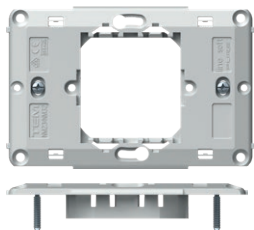

NM32

## NOSILEC Z VIJAKI 2/3M

- nosilec 2/3M z vijaki
- montaža v pravokotne doze velikosti 3M
- primeren za sestavo z okvirji LINE, SOFT, PURE in EDGE
- ustreza EN 60669-1

## MOUNTING FRAME WITH SCREWS 2/3M

- mounting frame 2/3M with screws
- for mounting on rectangular boxes 3M
- suitable for assembling with cover plates LINE, SOFT, PURE and EDGE
- in accordance with EN 60669-1

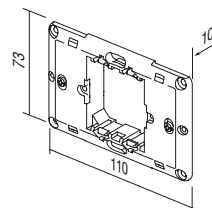



136



144



152



154

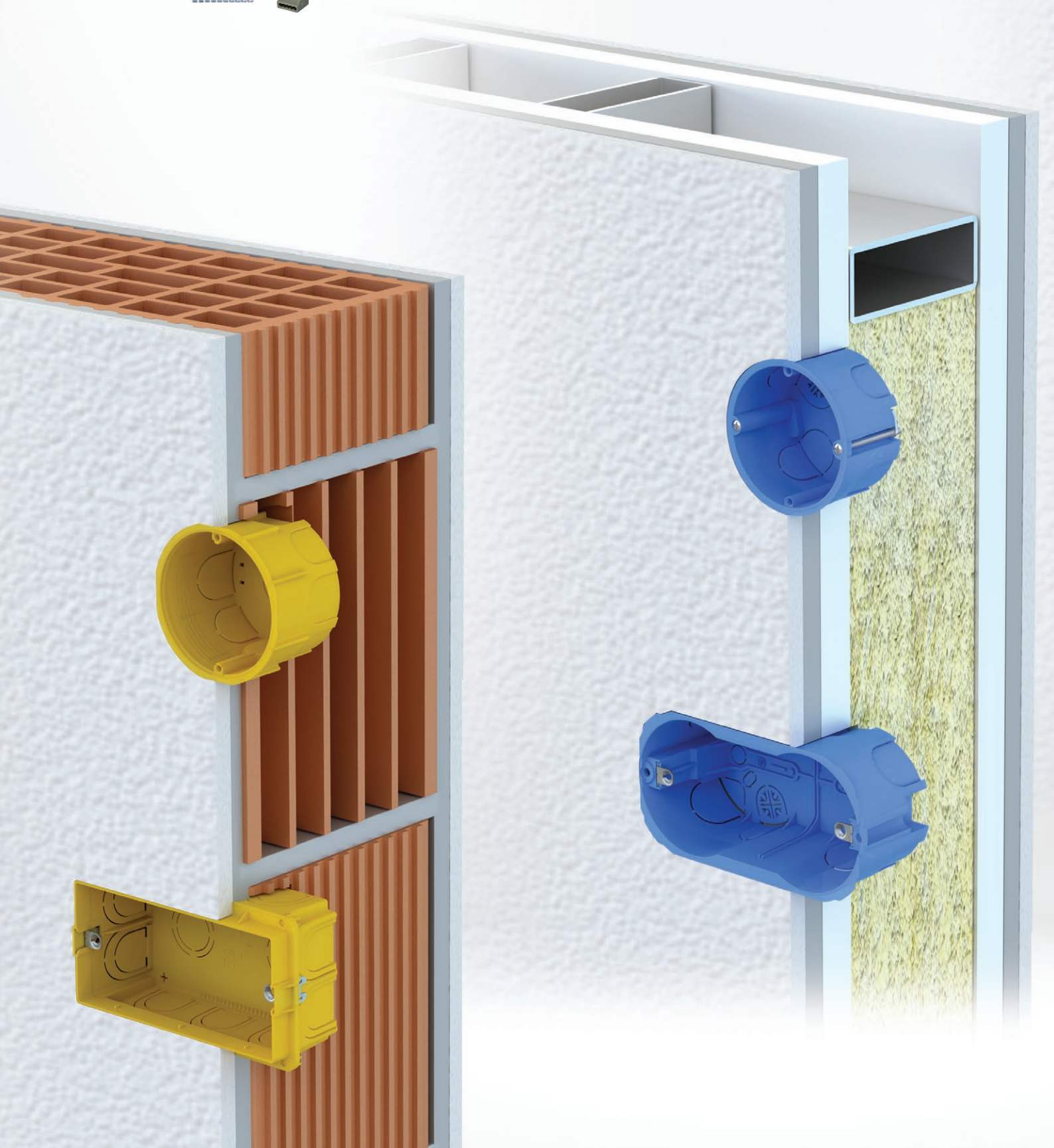



## DOZE

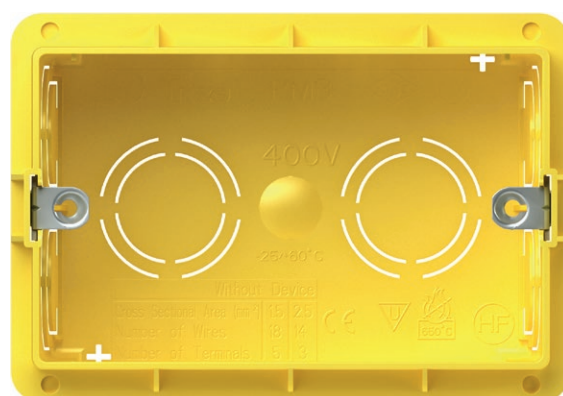

## TEM



DE12



HE11



BE10

tip type	naziv description	velikost size
DE10	DOZA OKROGLA ZA ZID ROUND BOX BRICK	SM60-01
HE10	DOZA OKROGLA ZA VOTLE STENE ROUND BOX HOLLOW WALL	SM68X40
BE10	DOZA OKROGLA ZA BETON ROUND BOX CONCRETE	
·	·	·
·	·	·

DOZA OKROGLA ZA ZID SM60-01



DE10

- Ø60, globina 40mm
- 650°C, 500V~
- ustreza IEC 60670-1
- "halogen free"
- možnost pritrditve nosilca z vijaki Ø 3 mm

ROUND BOX BRICK SM60-01

- Ø60, depth 40mm
- 650°C, 500V~
- in accordance with IEC 60670-1
- halogen free
- option of mounting the mounting frame with Ø 3 mm screws

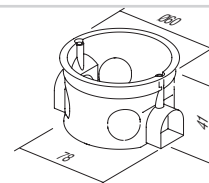

DOZA OKROGLA ZA ZID GLOBOKA SM60-06



DE11

- Ø60, globina 60mm
- 650°C, 500V~
- ustreza IEC 60670-1
- "halogen free"
- možnost pritrditve nosilca z vijaki Ø 3 mm

ROUND BOX BRICK DEEP SM60-06

- Ø60, depth 60mm
- 650°C, 500V~
- in accordance with IEC 60670-1
- halogen free
- option of mounting the mounting frame with Ø 3 mm screws

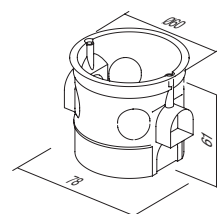

VEZNI ČLEN DOZE ZA ZID SM60-03



DE30

- za vertikalno povezavo doz SM60-06 ali SM60-01
- na razdaljo 91 mm
- ustreza IEC 60670-1
- "halogen free"

COMBI-CLIP SM60-03

- for vertical fitting of boxes SM60-06 or SM60-01 on distance 91 mm
- in accordance with IEC 60670-1
- halogen free

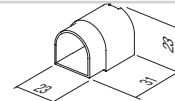

VEZNI ČLEN DOZE ZA ZID SM60-04

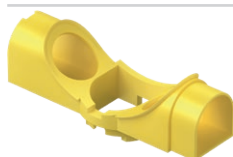

DE31

- za horizontalno povezavo doz SM60-06 ali SM60-01
- na razdaljo 71mm
- ustreza IEC 60670-1
- "halogen free"





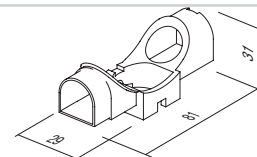





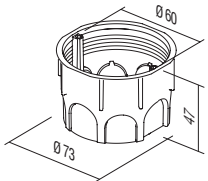

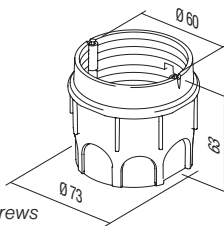

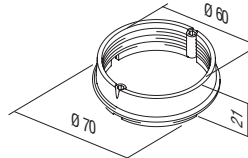
COMBI-CLIP SM60-04

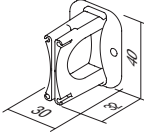
- for horizontal fitting of boxes SM60-06 or SM60-01 on distance 71mm
- in accordance with IEC 60670-1
- halogen free

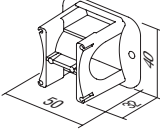

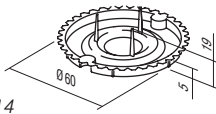

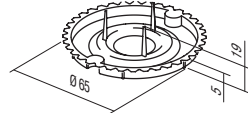
## R O U N D     B O X E S

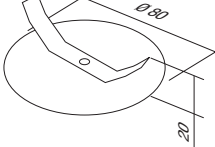
	DE12	DOZA OKROGLA ZA ZID MD65-46	<ul style="list-style-type: none"> <li>- Ø65, globina 46mm</li> <li>- 650°C, 500V~</li> <li>- ustreza IEC 60670-1</li> <li>- "halogen free"</li> <li>- možnost pritrditve nosilca z vijaki Ø 3 mm</li> </ul>	
		<i>ROUND BOX BRICK MD65-46</i>	<ul style="list-style-type: none"> <li>- Ø65, depth 46mm</li> <li>- 650°C, 500V~</li> <li>- in accordance with IEC 60670-1</li> <li>- halogen free</li> <li>- option of mounting the mounting frame with Ø 3 mm screws</li> </ul>	
	DE13	DOZA OKROGLA ZA ZID GLOBOKA MD65-60	<ul style="list-style-type: none"> <li>- Ø65/60, globina 62mm</li> <li>- 650°C, 500V~</li> <li>- ustreza IEC 60670-1</li> <li>- "halogen free"</li> <li>- možnost pritrditve nosilca z vijaki Ø 3 mm</li> </ul>	
		<i>ROUND BOX BRICK DEEP MD65-60</i>	<ul style="list-style-type: none"> <li>- Ø65/60, depth 62mm</li> <li>- 650°C, 500V~</li> <li>- in accordance with IEC 60670-1</li> <li>- halogen free</li> <li>- option of mounting the mounting frame with Ø 3 mm screws</li> </ul>	
	DE14	PODALJŠEK DOZE ZA ZID MD65-46	<ul style="list-style-type: none"> <li>- Ø65/60, globina 17mm</li> <li>- 650°C, 500V~</li> <li>- ustreza IEC 60670-1</li> <li>- "halogen free"</li> </ul>	
		<i>ADDITIONAL PIECE FOR MD65-46</i>	<ul style="list-style-type: none"> <li>- Ø65/60, depth 17mm</li> <li>- 650°C, 500V~</li> <li>- in accordance with IEC 60670-1</li> <li>- halogen free</li> </ul>	
	DE32	VEZNI ČLEN DOZE ZA ZID MD65-71	<ul style="list-style-type: none"> <li>- za povezavo doz MD65 na razdaljo 71 mm</li> <li>- ustreza IEC 60670-1</li> <li>- "halogen free"</li> </ul>	
		<i>COMBI-CLIP MD65-71</i>	<ul style="list-style-type: none"> <li>- for fitting of boxes MD65 on distance 71mm</li> <li>- in accordance with IEC 60670-1</li> <li>- halogen free</li> </ul>	
	DE33	VEZNI ČLEN DOZE ZA ZID MD65-91	<ul style="list-style-type: none"> <li>- za povezavo doz MD65 na razdaljo 91mm</li> <li>- ustreza IEC 60670-1</li> <li>- "halogen free"</li> </ul>	
		<i>COMBI-CLIP MD65-91</i>	<ul style="list-style-type: none"> <li>- for fitting of boxes MD65 on distance 91mm</li> <li>- in accordance with IEC 60670-1</li> <li>- halogen free</li> </ul>	
	DE20	POKROV DOZE ZAŠČITNI 60	<ul style="list-style-type: none"> <li>- zaščitni pokrov doze Ø60 za DE10, DE11, DE13, DE14</li> <li>- ustreza IEC 60670-1</li> <li>- za zaščito pri ometavanju</li> </ul>	
		<i>BOX COVER PROTECTIVE 60</i>	<ul style="list-style-type: none"> <li>- protective cover for box Ø60 for DE10, DE11, DE13, DE14</li> <li>- in accordance with IEC 60670-1</li> <li>- box protection during plastering</li> </ul>	
	DE21	POKROV DOZE ZAŠČITNI 65	<ul style="list-style-type: none"> <li>- zaščitni pokrov doze Ø65 za DE12</li> <li>- ustreza IEC 60670-1</li> <li>- za zaščito pri ometavanju</li> </ul>	
		<i>BOX COVER PROTECTIVE 65</i>	<ul style="list-style-type: none"> <li>- protective cover for box Ø65 for DE12</li> <li>- in accordance with IEC 60670-1</li> <li>- box protection during plastering</li> </ul>	
	DE22	POKROV DOZE DEKORATIVNI SM60	<ul style="list-style-type: none"> <li>- dekorativni pokrov doze Ø60</li> <li>- ustreza IEC 60670-1</li> <li>- "halogen free"</li> </ul>	
		<i>BOX COVER DECORATIVE SM60</i>	<ul style="list-style-type: none"> <li>- decorative cover for boxes Ø60</li> <li>- in accordance with IEC 60670-1</li> <li>- halogen free</li> </ul>	



navodila za montažo /  
assembly instructions

razdalja med dozami /  
distance between boxes: 71mm

razdalja med dozami /  
distance between boxes: 91mm

DE10,11

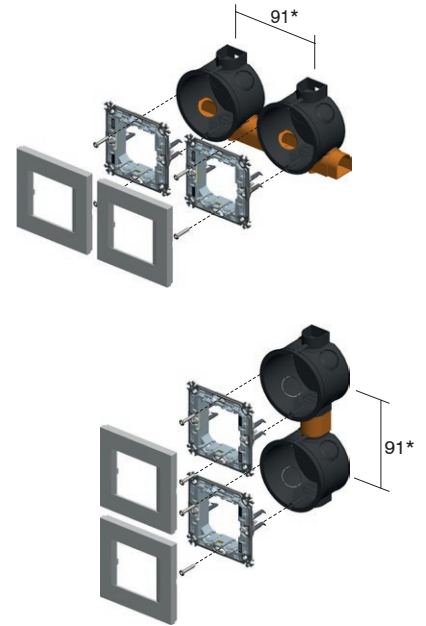
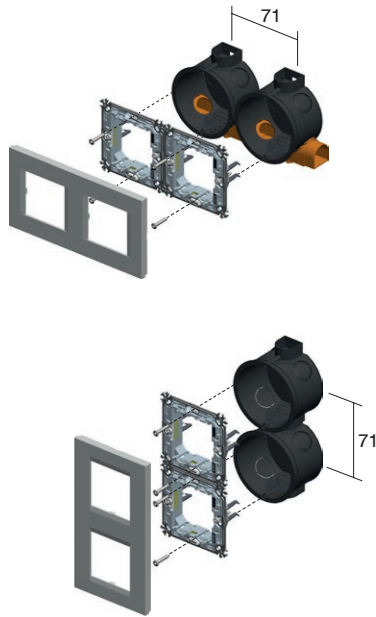
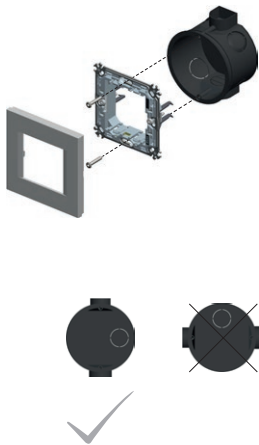

DE12,13

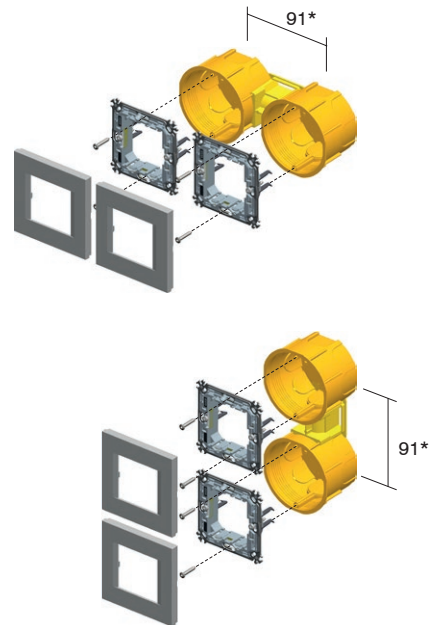
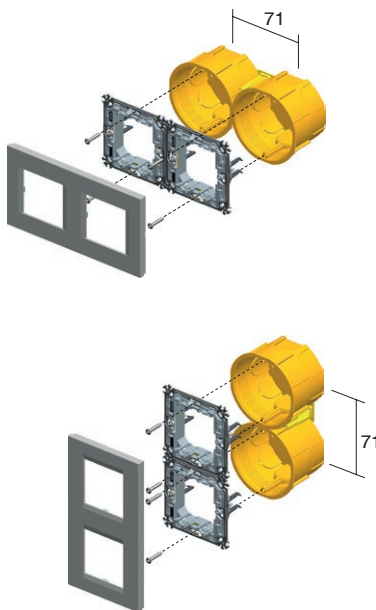
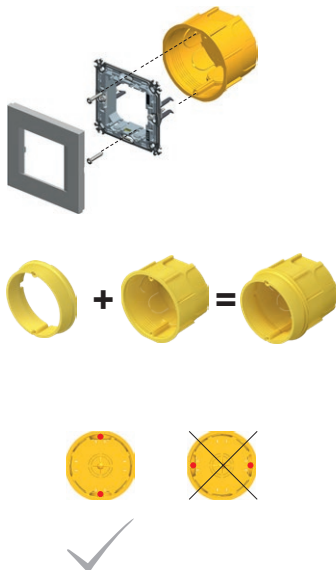

\* za okvirje PURE, EDGE je min. razdalja med dozami 100mm  
\* for PURE, EDGE cover plates the minimum distance between boxes is 100mm

R O U N D B O X E S



DE10,11



DE12,13



NM20



NM24,26



DE10,11



DE12,13



NM10



DE10,11



DE12,13



NM23



71

2xDE10,11 + 2xDE31



2xDE12,13 + 1xDE32



2xNM20



2xNM24,26



2xDE10,11



2xDE12,13 + 1xDE32



2xNM20



2xNM24,26



3xDE10,11 + 3xDE31



3xDE12,13 + 2xDE32



3xNM20



3xNM24,26

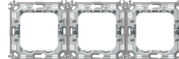

3xDE10,11



3xDE12,13 + 2xDE32



3xNM20



3xNM24,26



4xDE10,11 + 4xDE31



4xDE12,13 + 3xDE32



4xNM20



4xNM24,26



4xDE10,11



4xDE12,13 + 3xDE32



4xNM20



4xNM24,26



5xDE10,11



5xDE12,13 + 4xDE32



5xNM20



5xNM24,26



DOZA OKROGLA ZA VOTLE STENE SM68x40



HE10

- Ø60, globina 40mm
- vgradnja v izvrtino Ø68
- 850°C, 400V~
- ustreza IEC 60670-1
- montaža s krepeljci
- "halogen free"
- pritrnitev nosilca z vijaki Ø 3 mm

*ROUND BOX HOLLOW WALL SM68x40*

- Ø60, depth 40mm
- cutting hole Ø68
- 850°C, 400V~
- in accordance with IEC 60670-1
- mounting with claws
- halogen free
- mounting the mounting frame with Ø 3 mm screws

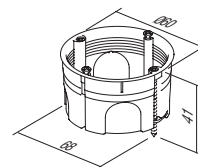

DOZA OKROGLA ZA VOTLE STENE SM68x55



HE11

- Ø60, globina 55mm
- vgradnja v izvrtino Ø68
- 850°C, 400V~
- ustreza IEC 60670-1
- montaža s krepeljci
- "halogen free"
- pritrnitev nosilca z vijaki Ø 3 mm

*ROUND BOX HOLLOW WALL SM68x55*

- Ø60, depth 55mm
- cutting hole Ø68
- 850°C, 400V~
- in accordance with IEC 60670-1
- mounting with claws
- halogen free
- mounting the mounting frame with Ø 3 mm screws

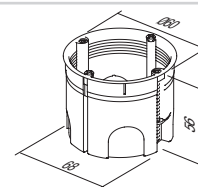

DOZA OKROGLA ZA BETON



BE10

- Ø60mm, globina 49mm
- 650°C, 500V~
- ustreza IEC 60670-1
- "halogen free"
- pritrnitev nosilca z vijaki Ø 3 mm

*ROUND BOX CONCRETE*

- Ø60mm, depth 49mm
- 650°C, 500V~
- in accordance with IEC 60670-1
- halogen free
- mounting the mounting frame with Ø 3 mm screws

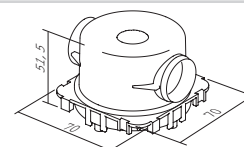

DOZA OKROGLA ZA BETON GLOBOKA



BE11

- Ø60mm, globina 58mm
- 650°C, 500V~
- ustreza IEC 60670-1
- "halogen free"
- pritrnitev nosilca z vijaki Ø 3 mm

*ROUND BOX CONCRETE DEEP*

- Ø60mm, depth 58mm
- 650°C, 500V~
- in accordance with IEC 60670-1
- halogen free
- mounting the mounting frame with Ø 3 mm screws

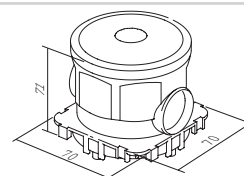

NOSILEC DOZE ZA BETON



BE20

- za utrditev doze z distančnim profilom BM82 v nasprotno steno
- ustreza IEC 60670-1
- "halogen free"

*COUNTER BOX SUPPORT CONCRETE*

- to support concrete boxes with discance profile BM82 for extreme loads
- in accordance with IEC 60670-1
- halogen free

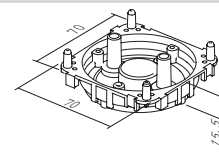

UVODNICA DOZE ZA BETON 16



BE21

- za utrditev instalacijske cevi
- ustreza IEC 60670-1
- "halogen free"

*PIPE STOPPER CONCRETE BOX 16*

- for firming installation pipe to box
- in accordance with IEC 60670-1
- halogen free

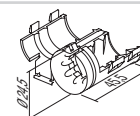

## R O U N D

## B O X E S

votle stene / hollow walls



beton / concrete



navodila za montažo /  
assembly instructions

razdalja med dozami /  
distance between boxes: 71mm

razdalja med dozami /  
distance between boxes: 91mm

HE10,11

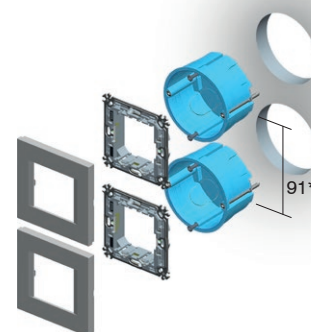
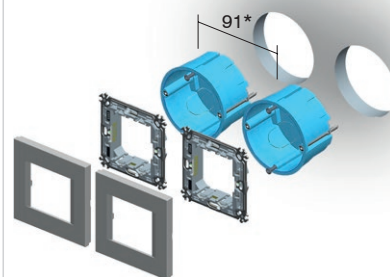
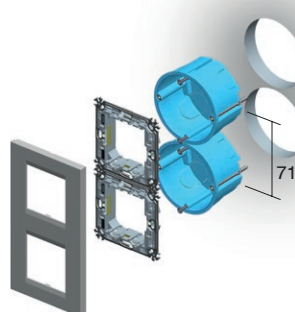
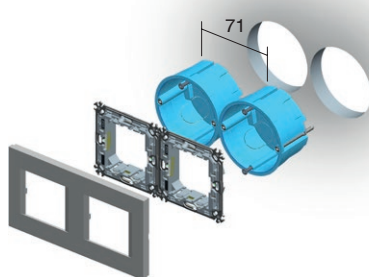
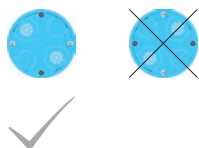
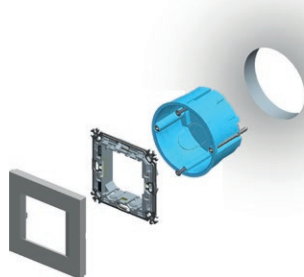

BE10

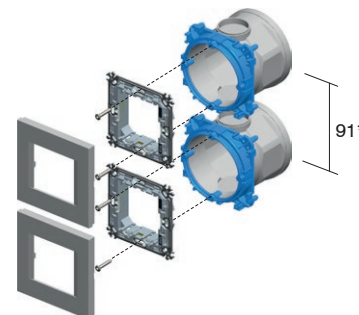
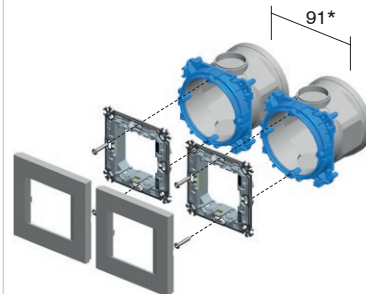
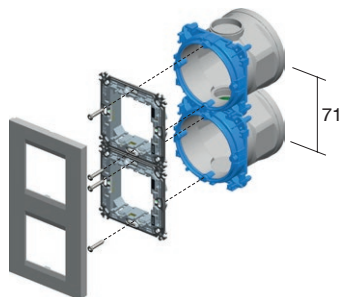
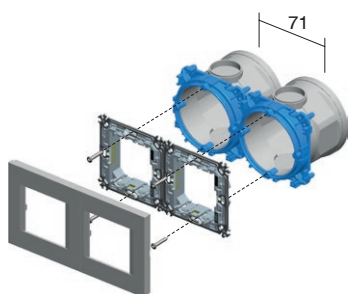
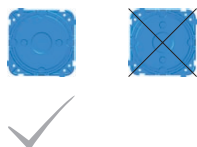
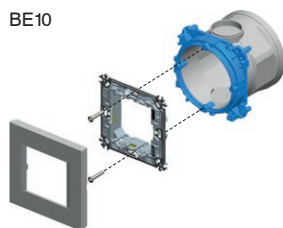

\* za okvirje PURE, EDGE je min. razdalja med dozami 100mm

\* for PURE, EDGE cover plates the minimum distance between boxes is 100mm

votle stene / hollow walls



beton / concrete



HE10,11



BE10,11



NM21



NM25,27



2M

HE10,11



BE10,11



NM11



1/2M

2xHE10,11



2xBE10,11



2xNM21



2xNM25,27



2x2M

HE10,11



BE10,11



NM32

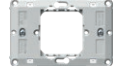

2/3M

2xHE10,11



2xBE10,11



2xNM21



2xNM25,27



5xHE10,11

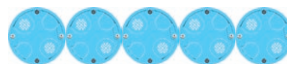

5xNM21



5xBE10,11



5xNM25,27



5x2M

3xHE10,11



3xBE10,11



3xNM21



3xNM25,27

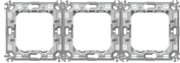

3x2M

3xHE10,11



3xBE10,11



3xNM21



3xNM25,27

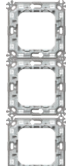

4xHE10,11



4xBE10,11



4xNM21



4xNM25,27



4x2M

4xHE10,11



4xBE10,11



4xNM21



4xNM25,27



## R O U N D     B O X E S

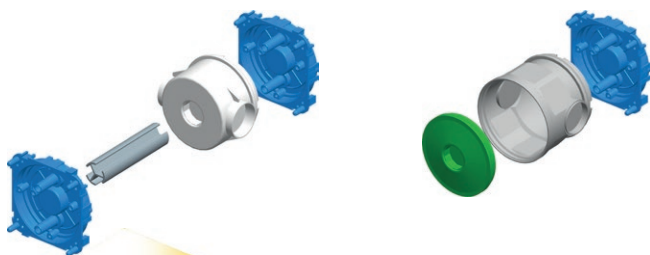

navodila za montažo /  
assembly instructions

1

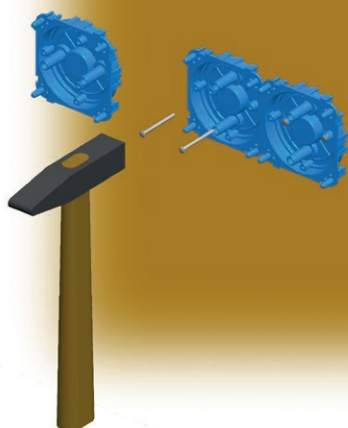

3

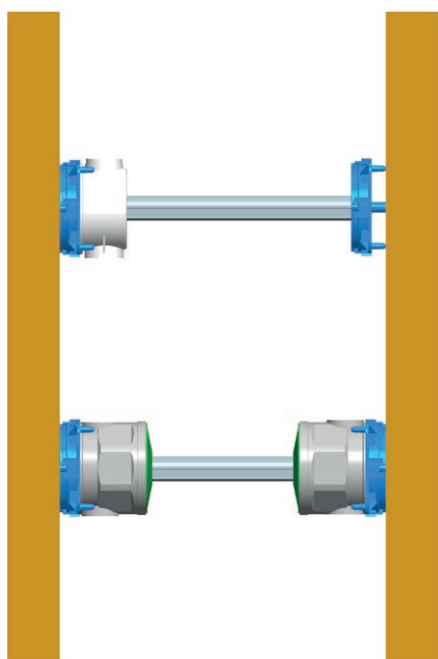

2

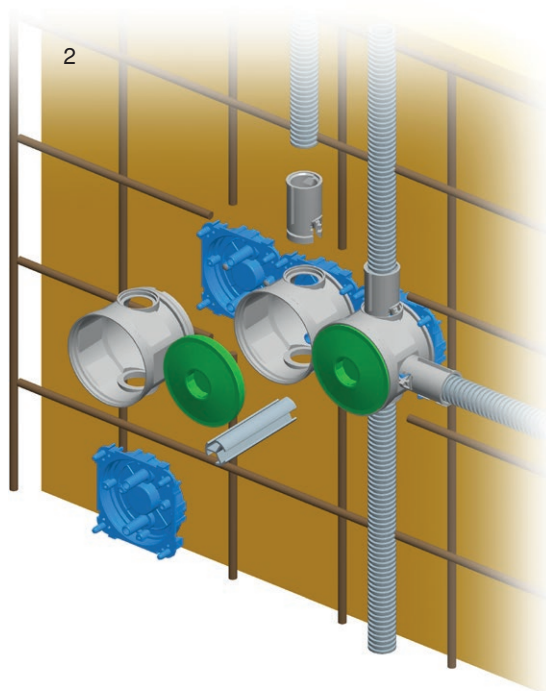

4

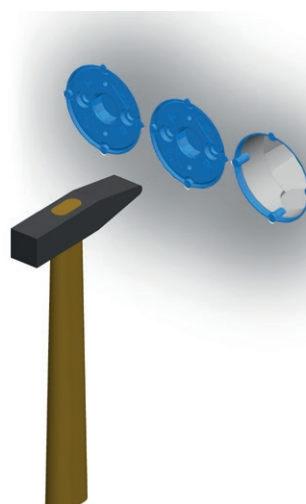



DM30



HM30



BM30

tip type	naziv description	velikost size
DM30	DOZA PRAVOKOTNA ZA ZID RECTANGULAR BOX BRICK	PM3
HM30	DOZA PRAVOKOTNA ZA VOTLE STENE RECTANGULAR BOX HOLLOW WALL	VM3
BM30	DOZA PRAVOKOTNA ZA BETON RECTANGULAR BOX CONCRETE	BM3
·	·	·
·	·	·

DOZA PRAVOKOTNA ZA ZID PM3



DM30

- velikost 3M, globina 49mm
- 650°C, 400V~
- ustreza IEC 60670-1
- "halogen free"

RECTANGULAR BOX BRICK PM3

- size 3M, depth 49mm
- 650°C, 400V~
- in accordance with IEC 60670-1
- halogen free

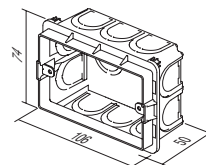

DOZA PRAVOKOTNA ZA ZID PM3-65



DM31

- velikost 3M, globina 65mm
- 650°C, 400V~
- ustreza IEC 60670-1
- "halogen free"

RECTANGULAR BOX BRICK PM3-65

- size 3M, depth 65mm
- 650°C, 400V~
- in accordance with IEC 60670-1
- halogen free

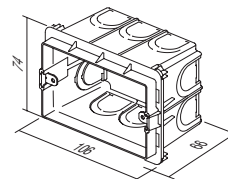

DOZA PRAVOKOTNA ZA ZID PM4



DM40

- velikosti 4M, globina 49mm
- 650°C, 400V~
- ustreza IEC 60670-1
- "halogen free"

RECTANGULAR BOX BRICK PM4

- size 4M, depth 49mm
- 650°C, 400V~
- in accordance with IEC 60670-1
- halogen free

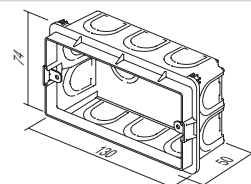

DOZA PRAVOKOTNA ZA ZID PM4-65



DM41

- velikosti 4M, globina 65mm
- 650°C, 400V~
- ustreza IEC 60670-1
- "halogen free"

RECTANGULAR BOX BRICK PM4-65

- size 4M, depth 65mm
- 650°C, 400V~
- in accordance with IEC 60670-1
- halogen free

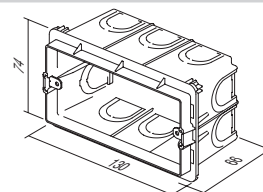



## R E C T A N G U L A R   B O X E S

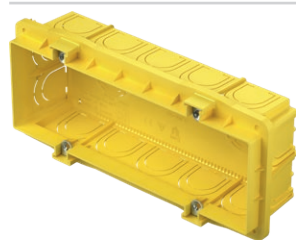

DM70

## DOZA PRAVOKOTNA ZA ZID PM7

- velikost 7M, globina 49mm
- 650 °C, 400V~
- ustreza IEC 60670-1
- "halogen free"

## RECTANGULAR BOX BRICK PM7

- size 7M, depth 49mm
- 650 °C, 400V~
- in accordance with IEC 60670-1
- halogen free

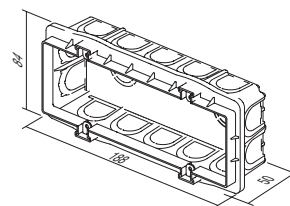

DM71

## DOZA PRAVOKOTNA ZA ZID PM7-65

- velikost 7M, globina 65mm
- 650 °C, 400V~
- ustreza IEC 60670-1
- "halogen free"

## RECTANGULAR BOX BRICK PM7-65

- size 7M, depth 65mm
- 650 °C, 400V~
- in accordance with IEC 60670-1
- halogen free

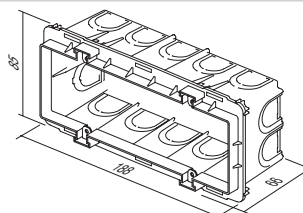

DM72

## DOZA PRAVOKOTNA ZA ZID PM72-65

- velikost 2x7M, globina 64mm
- 650 °C, 400V~
- ustreza IEC 60670-1
- "halogen free"

## RECTANGULAR BOX BRICK PM72-65

- size 2x7M, depth 64mm
- 650 °C, 400V~
- in accordance with IEC 60670-1
- halogen free

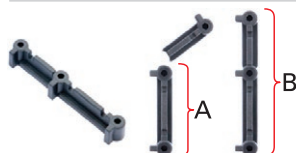
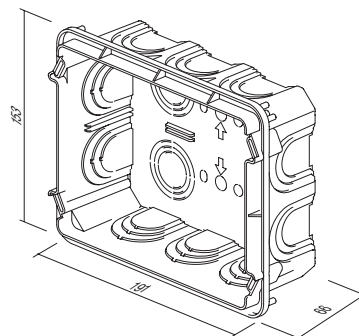

DM80

## VEZNI ČLEN DOZE PM

- za vertikalno (A) in horizontalno (B) sestavo doz PM3, PM4 in PM7
- primeren za dekorativne okvirje Line in Soft (za PURE in EDGE ni primeren)

## DISTANCE PIECE FOR BOX PM

- for vertical (A) and horizontal (B) fitting of boxes PM3, PM4 and PM7
- suitable for Line and Soft decorative cover plates (not for PURE and EDGE)

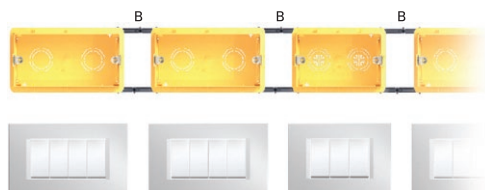
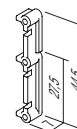

POKROV DOZE ZAŠČITNI PM3



DM33

- zaščitni pokrov doze PM3
- ustreza IEC 60670-1
- "halogen free"
- za zaščito pri ometavanju

*BOX COVER PROTECTIVE PM3*

- protective cover for box PM3
- in accordance with IEC 60670-1
- halogen free
- box protection during plastering

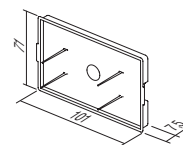

POKROV DOZE DEKORATIVNI PM3



DM34

- dekorativni pokrov doze 3M
- vijaka priložena
- ustreza IEC 60670-1
- "halogen free"

*BOX COVER DECORATIVE PM3*

- decorative cover for boxes 3M
- screws are included
- in accordance with IEC 60670-1
- halogen free

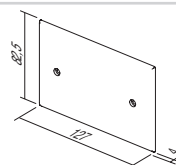

POKROV DOZE ZAŠČITNI PM4



DM43

- zaščitni pokrov doze PM4
- ustreza IEC 60670-1
- "halogen free"
- za zaščito pri ometavanju

*BOX COVER PROTECTIVE PM4*

- protective cover for box PM4
- in accordance with IEC 60670-1
- halogen free
- box protection during plastering

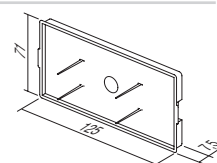

POKROV DOZE DEKORATIVNI PM4



DM44

- dekorativni pokrov doze 4M
- vijaka priložena
- ustreza IEC 60670-1
- "halogen free"

*BOX COVER DECORATIVE PM4*

- decorative cover for boxes 4M
- screws are included
- in accordance with IEC 60670-1
- halogen free

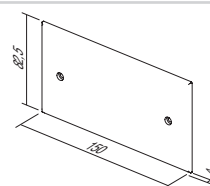

POKROV DOZE ZAŠČITNI PM7

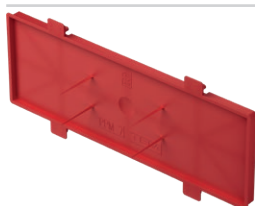

DM73

- zaščitni pokrov doze PM7
- ustreza IEC 60670-1
- "halogen free"
- za zaščito pri ometavanju

*BOX COVER PROTECTIVE PM7*

- protective cover for box PM7
- in accordance with IEC 60670-1
- halogen free
- box protection during plastering

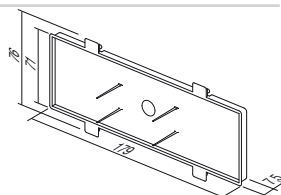

POKROV DOZE DEKORATIVNI PM7



DM74

- dekorativni pokrov doze 7M
- vijaka priložena
- ustreza IEC 60670-1
- "halogen free"

*BOX COVER DECORATIVE PM7*

- decorative cover for boxes 7M
- screws are included
- in accordance with IEC 60670-1
- halogen free

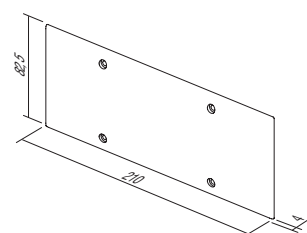

## R E C T A N G U L A R   B O X E S



DM75

## POKROV DOZE DEKORATIVNI PM72

- dekorativni pokrov doze 2x7M
- vijaki priloženi
- ustreza IEC 60670-1

*BOX COVER DECORATIVE PM72*

- decorative cover for boxes 2x7M
- screws are included
- in accordance with IEC 60670-1

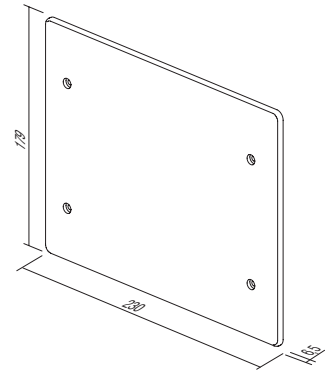

DOZA PRAVOKOTNA ZA VOTLE STENE VM3



HM30

- velikost 3M, globina 49mm
- vgradnja v izvrtino 2xØ68/45mm
- 850°C, 400V~
- ustreza IEC 60670-1
- "halogen free"

RECTANGULAR BOX HOLLOW WALL VM3

- size 3M, depth 49mm
- cutting hole 2xØ68/45mm
- 850°C, 400V~
- in accordance with IEC 60670-1
- halogen free

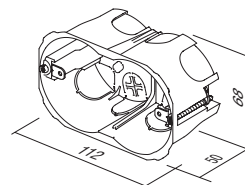

DOZA PRAVOKOTNA ZA VOTLE STENE VM4



HM40

- velikost 4M, globina 49mm
- vgradnja v izvrtino 2xØ68/70mm
- 850°C, 400V~
- ustreza IEC 60670-1
- "halogen free"

RECTANGULAR BOX HOLLOW WALL VM4

- size 4M, depth 49mm
- cutting hole 2xØ68/70mm
- 850°C, 400V~
- in accordance with IEC 60670-1
- halogen free

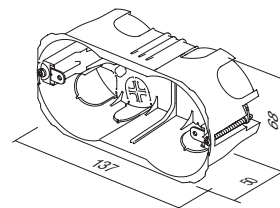

DOZA PRAVOKOTNA ZA VOTLE STENE VM7



HM70

- velikost 7M, globina 49mm
- vgradnja v izvrtino 2xØ68/120mm
- 850°C, 400V~
- ustreza IEC 60670-1
- "halogen free"

RECTANGULAR BOX HOLLOW WALL VM7

- size 7M, depth 49mm
- cutting hole 2xØ68/120mm
- 850°C, 400V~
- in accordance with IEC 60670-1
- halogen free

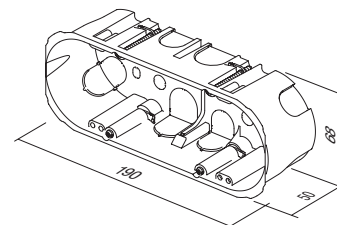

DOZA PRAVOKOTNA ZA VOTLE STENE VM72



HM72







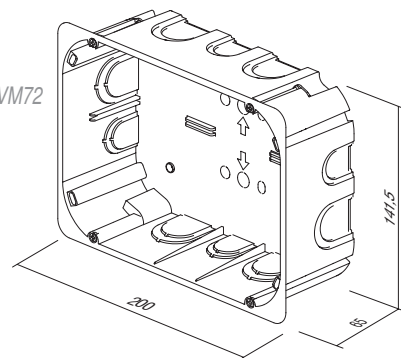

- velikost 2x7M, globina 63mm
- 850°C, 400V~
- ustreza IEC 60670-1
- "halogen free"

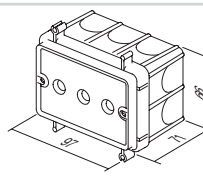
RECTANGULAR BOX HOLLOW WALL VM72

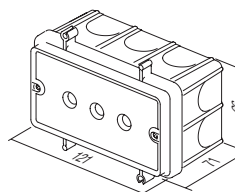
- size 2x7M, depth 63mm
- 850°C, 400V~
- in accordance with IEC 60670-1
- halogen free

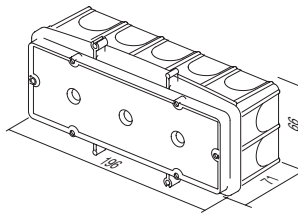

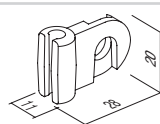
## R E C T A N G U L A R   B O X E S

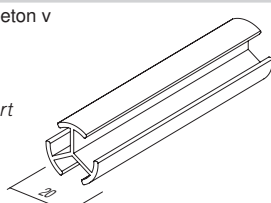
	BM30	DOZA PRAVOKOTNA ZA BETON BM3	<ul style="list-style-type: none"> <li>- velikost 3M, globina 60mm</li> <li>- 650°C, 400V~</li> <li>- ustreza IEC 60670-1</li> <li>- "halogen free"</li> </ul>	
	BM40	DOZA PRAVOKOTNA ZA BETON BM4	<ul style="list-style-type: none"> <li>- velikost 4M, globina 60mm</li> <li>- 650°C, 400V~</li> <li>- ustreza IEC 60670-1</li> <li>- "halogen free"</li> </ul>	
	BM70	DOZA PRAVOKOTNA ZA BETON BM7	<ul style="list-style-type: none"> <li>- velikost 7M, globina 60mm</li> <li>- 650°C, 400V~</li> <li>- ustreza IEC 60670-1</li> <li>- "halogen free"</li> </ul>	
	BM80	PRITRDILNI ČLEN DOZ BM	<ul style="list-style-type: none"> <li>- za hitro pritrnitev pravokotnih doz BM na armaturno mrežo</li> <li>- primerno za palice do premera Ø8mm</li> </ul>	
	BM82	DISTANČNI PROFIL ZA DOZE	<ul style="list-style-type: none"> <li>- za utrditev doz BM skupaj z nosilcem doze za beton v nasprotno steno</li> <li>- dolžina l=1m, premer Ø20mm</li> </ul>	
			<p><i>RECTANGULAR BOX CONCRETE BM3</i></p> <ul style="list-style-type: none"> <li>- size 3M, depth 60mm</li> <li>- 650°C, 400V~</li> <li>- in accordance with IEC 60670-1</li> <li>- halogen free</li> </ul>	
			<p><i>RECTANGULAR BOX CONCRETE BM4</i></p> <ul style="list-style-type: none"> <li>- size 4M, depth 60mm</li> <li>- 650°C, 400V~</li> <li>- in accordance with IEC 60670-1</li> <li>- halogen free</li> </ul>	
			<p><i>RECTANGULAR BOX CONCRETE BM7</i></p> <ul style="list-style-type: none"> <li>- size 7M, depth 60mm</li> <li>- 650°C, 400V~</li> <li>- in accordance with IEC 60670-1</li> <li>- halogen free</li> </ul>	
			<p><i>FIXING COMBI-CLIP BM</i></p> <ul style="list-style-type: none"> <li>- for fast fixation of BM rectangular boxes on reinforcing bar</li> <li>- suitable for bar diameter up to Ø8mm</li> </ul>	
			<p><i>DISTANCE PROFIL FOR BOXES BM</i></p> <ul style="list-style-type: none"> <li>- to support boxes BM with counter box support on opposite wall</li> <li>- length l=1m, diameter Ø20mm</li> </ul>	

# P R A V O K O T N E D O Z E



opeka / brick



votle stene / hollow walls

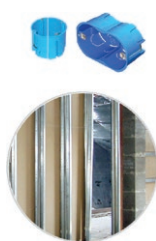

beton / concrete

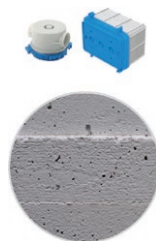

DM30		 <b>NM30</b>	<b>3M</b>
HM30			
BM30			
DM40		 <b>NM40</b>	<b>4M</b>
HM40			
BM40			
DM70		 <b>NM70,75</b>	<b>7M</b>
HM70			
BM70			
DM72		 <b>NM72</b>	<b>2x7M</b>
HM72			
DM30		 <b>NM32</b>	<b>2/3M</b>
HM30			
BM30			

## R E C T A N G U L A R   B O X E S

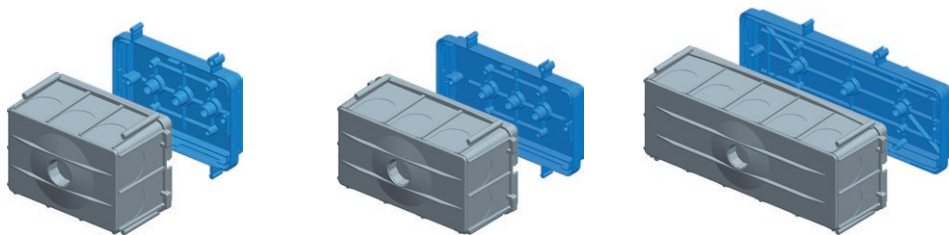

navodila za montažo /  
assembly instructions

1

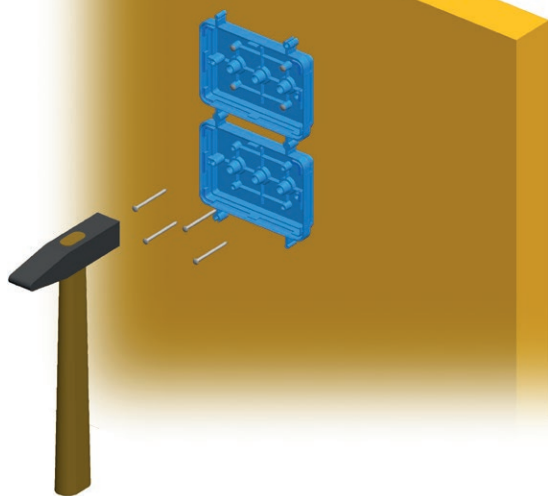

2

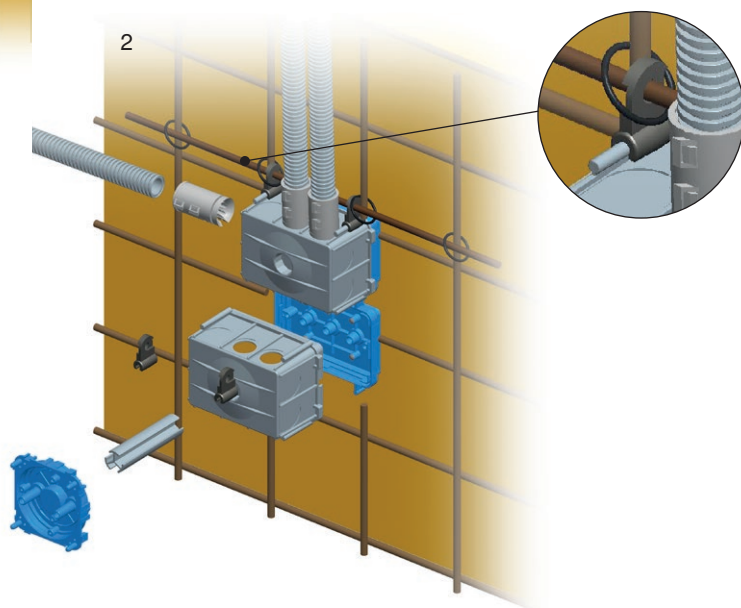

3

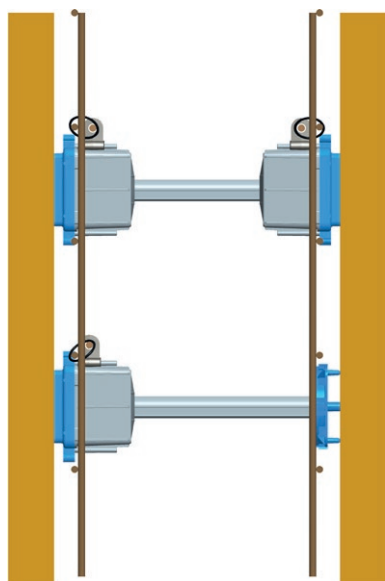

4

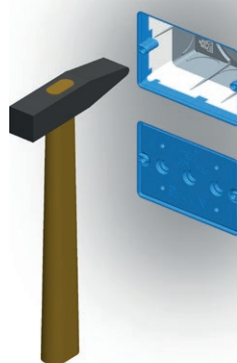

RAZVODNA DOZA OKROGLA ZA ZID DSM78



DW10

- Ø78, globina 40mm
- 650°C, 500V~
- ustreza IEC 60670-1 in IEC 60670-22
- "halogen free"

CONNECTION ROUND BOX BRICK DSM78

- Ø78, depth 40mm
- 650°C, 500V~
- in accordance with IEC 60670-1 and IEC 60670-22
- halogen free

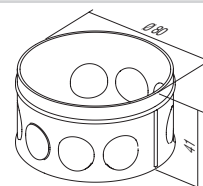

RAZVODNA DOZA OKROGLA ZA VOTLE STENE SM78x45



HW10

- Ø78, globina 45mm
- vgradnja v izvrtino Ø80
- 850°C, 400V~
- ustreza IEC 60670-1 in IEC 60670-22
- montaža s krepeljci
- "halogen free"

CONNECTION ROUND BOX HOLLOW WALL SM78x45

- Ø78, depth 45mm
- cutting hole Ø80
- 850°C, 400V~
- in accordance with IEC 60670-1 and IEC 60670-22
- mounting with claws
- halogen free

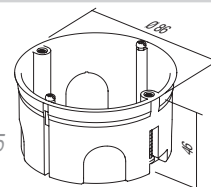

POKROV DOZE DEKORATIVNI SM78



DE23

- dekorativni pokrov doze Ø78
- ustreza IEC 60670-1 and IEC 60670-22
- "halogen free"

BOX COVER DECORATIVE SM78

- decorative cover for boxes Ø78
- in accordance with IEC 60670-1 and IEC 60670-22
- halogen free

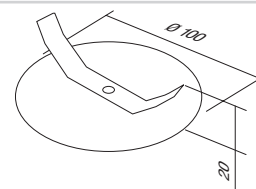

POKROV DOZE ZAŠČITNI 78



DE24

- zaščitni pokrov doze Ø78
- ustreza IEC 60670-1 in IEC 60670-22
- "halogen free"

BOX COVER PROTECTIVE 78

- protective cover for box Ø78
- in accordance with IEC 60670-1 and IEC 60670-22
- halogen free

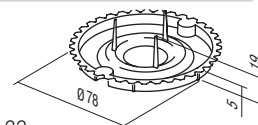

RAZVODNA DOZA KVADRATNA ZA VOTLE STENE SM105x105



HW20

- 105x105mm, globina 50mm
- vgradnja v izvrtino s priloženo šablono
- 850°C, 400V~
- ustreza IEC 60670-1 in IEC 60670-22
- montaža s krepeljci
- "halogen free"

CONNECTION SQUARE BOX HOLLOW WALL SM105x105

- size 105x105mm, depth 50mm
- cutting hole according to attached template
- 850°C, 400V~
- in accordance with IEC 60670-1 and IEC 60670-22
- mounting with claws
- halogen free

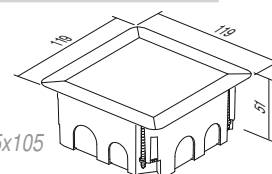





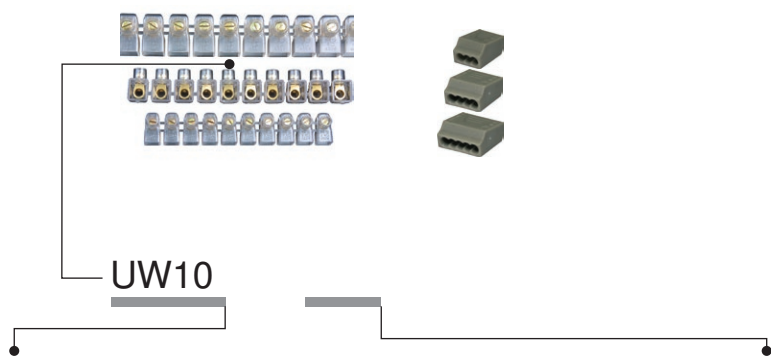

tip type	naziv description	tehnični opis technical data	velikost size	barva colour
UW10	ENOREDNE SPONKE ZAPRTE 1 ROW TERMINAL BLOCKS	2x2.5mm <sup>2</sup>	10P	<input checked="" type="checkbox"/> TS prozorna transparent
UW11	ENOREDNE SPONKE ZAPRTE 1 ROW TERMINAL BLOCKS	2x4mm <sup>2</sup>	10P	<input checked="" type="checkbox"/> CO barvne colour
UW12	ENOREDNE SPONKE ZAPRTE 1 ROW TERMINAL BLOCKS	2x6mm <sup>2</sup>	10P	<input type="checkbox"/> WH bela white
⋮	⋮	⋮	⋮	<input type="checkbox"/> GY siva grey

### ENOREDNE SPONKE ZAPRTE



- 450V~; 2x2.5mm<sup>2</sup> ÷ 2x6mm<sup>2</sup>  
- termoplast PC, prozorne  
- število polov: 10

#### 1 ROW TERMINAL BLOCKS CLOSED

- 450V~; 2x2.5mm<sup>2</sup> ÷ 2x6mm<sup>2</sup>  
- thermoplast PC, transparent  
- number of poles: 10

UW10TS	(NS12)	2x2.5mm <sup>2</sup>	10P
UW11TS	(NS12)	2x4mm <sup>2</sup>	10P
UW12TS	(NS12)	2x6mm <sup>2</sup>	10P

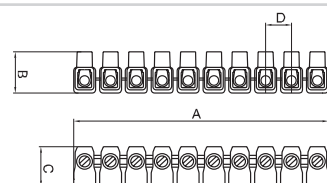

	A	B	C	D
2x2.5 □	110	17.5	17.5	11
2x4 □	128	21	19	12.5
2x6 □	146	21.5	22	15

### ENOREDNE SPONKE

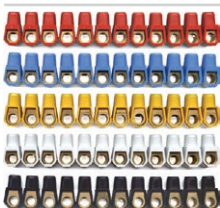

- 450V~; 2x2.5mm<sup>2</sup> ÷ 2x6mm<sup>2</sup>  
- termoplast PA  
- na voljo v različnih barvah  
- število polov: 12

#### 1 ROW TERMINAL BLOCKS

- 450V~; 2x2.5mm<sup>2</sup> ÷ 2x6mm<sup>2</sup>  
- thermoplast PA  
- available in different colours  
- number of poles: 12

UW15CO	(NS12)	2x2.5mm <sup>2</sup>	12P
UW16CO	(NS12)	2x4mm <sup>2</sup>	12P
UW17CO	(NS12)	2x6mm <sup>2</sup>	12P

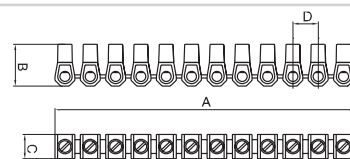

	A	B	C	D
2x2.5 □	110	16.4	9	10
2x4 □	118.8	19	10	10
2x6 □	129.8	21.3	11	11.8

### DVOREDNE SPONKE PP

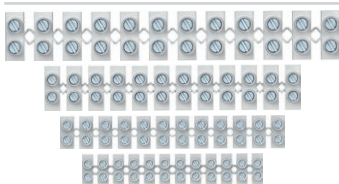

- 450 V~; 1 mm<sup>2</sup> ÷ 16 mm<sup>2</sup>  
- termoplast polipropilen PP, bele  
- za uporabo do 80°C  
- število polov: 12

#### 2 ROW TERMINAL BLOCKS PP

- 450V~; 1mm<sup>2</sup> ÷ 16mm<sup>2</sup>  
- thermoplast polypropylene PP, white  
- for temperatures up to 80°C  
- number of poles: 12

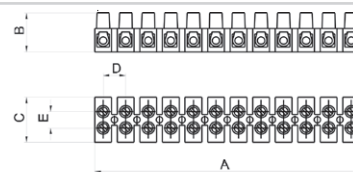

					A	B	C	D	E
UW29WHPP	1.0-4.0mm <sup>2</sup>	24 A	450 V		94,9	13	16,6	8,1	6,4
UW30WHPP	1.5-6.0mm <sup>2</sup>	32 A	450 V		116,5	14,9	18,9	10	7,3
UW31WHPP	2.5-10mm <sup>2</sup>	41 A	450 V		133,8	17,3	23,4	11,5	10
UW32WHPP	4-16mm <sup>2</sup>	76 A	450 V		174,5	20,7	25	15	11

## DVOREDNE SPONKE PA

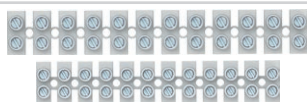

- 450 V~; 1 mm<sup>2</sup> ÷ 16 mm<sup>2</sup>
- termoplast poliamid PA, bele
- za uporabo do 110°C
- število polov: 12

## 2 ROW TERMINAL BLOCKS PA

- 450V~; 1mm<sup>2</sup> ÷ 16mm<sup>2</sup>
- thermoplast polyamide PA, white
- for temperatures up to 110°C
- number of poles: 12

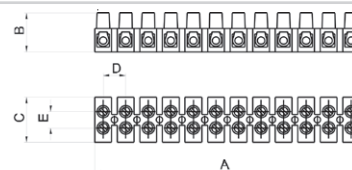

					A	B	C	D	E
UW27WHPA	2.5-10mm <sup>2</sup>	41 A	450 V		132,8	17,3	22,2	11,5	10
UW28WHPA	4-16mm <sup>2</sup>	76 A	450 V		173,9	20,8	25,2	15	11

## BREZVIJAČNE SPONKE



- 24A 450V~, termoplast PA, sive
- število polov: 3÷8
- brezvijačni kontakti 0.5 ÷ 1.5mm<sup>2</sup>, za trde žice
- ustreza EN 60998-1

## PLUG-IN WIRE CONNECTORS

- 24A 450V~, thermoplast PA, grey
- number of poles: 3÷8
- plug-in contacts 0.5÷1.5mm<sup>2</sup>, for rigide wires
- in accordance with EN 60998-1



UW40GY	PC153	1.5mm <sup>2</sup>	3P	3P	A	B	C
UW41GY	PC155	1.5mm <sup>2</sup>	5P	5P	12	18	9
UW42GY	PC158	1.5mm <sup>2</sup>	8P	8P	17	18	9
					26	18	9

## BREZVIJAČNE SPONKE



- 24A 450V~, termoplast PA, sive
- število polov: 3÷5
- brezvijačni kontakti 1.5 ÷ 2.5mm<sup>2</sup>, za trde žice
- ustreza EN 60998-1

## PLUG-IN WIRE CONNECTORS

- 24A 450V~, thermoplast PA, grey
- number of poles: 3÷5
- plug-in contacts 1.5÷2.5mm<sup>2</sup>, for rigide wires
- in accordance with EN 60998-1



UW45GY	PC253	2.5mm <sup>2</sup>	3P	3P	A	B	C
UW46GY	PC254	2.5mm <sup>2</sup>	4P	4P	14	19	9
UW47GY	PC255	2.5mm <sup>2</sup>	5P	5P	17	19	9
					21	19	9

## BREZVIJAČNE SPONKE



- 24A 450V~, termoplast PA, sive
- število polov: 2 (trda žica)+1 (mehka žica)
- brezvijačni kontakti 1.5 ÷ 2.5mm<sup>2</sup>
- ustreza EN 60998-1

## PLUG-IN WIRE CONNECTOR

- 24A 450V~, thermoplast PA, grey
- number of poles: 2 (rigide wire)+1 (soft wire)
- plug-in contacts 1.5÷2.5mm<sup>2</sup>
- in accordance with EN 60998-1

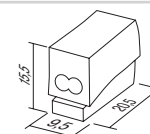

UW50WH	PC302	2.5mm <sup>2</sup>	2/1P
--------	-------	--------------------	------



158



159



161

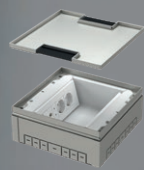

166

# DISTRIBUCIJA



**TEM**



# O H I Š J A C U B O I P 2 0 A C

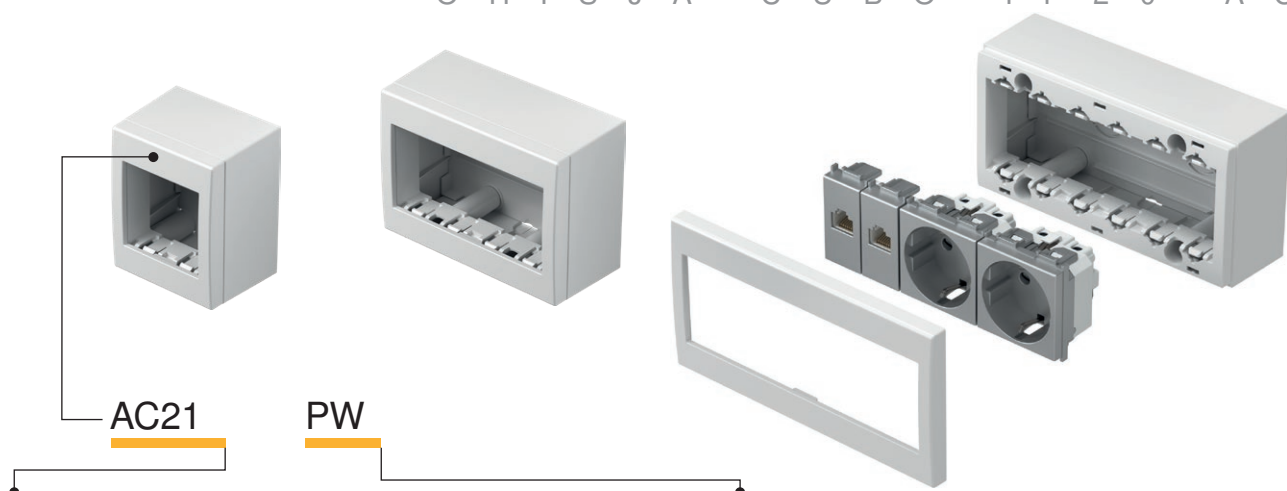

tip type	naziv description	tehnični opis technical data	velikost size	barva colour
AC11	OHIŠJE NO CUBO Z DNOM SURFACE MOUNT BOX WITH BACK SIDE COVER	IP20	1M	<input type="checkbox"/> PW bela-sijaj polar white <input type="checkbox"/> ES srebrna-mat elox silver
AC21	OHIŠJE NO CUBO Z DNOM SURFACE MOUNT BOX WITH BACK SIDE COVER	IP20	2M	<input type="checkbox"/> IW bež-sijaj ivory white <input type="checkbox"/> AT antracit anthracite
AC41	OHIŠJE NO CUBO Z DNOM SURFACE MOUNT BOX WITH BACK SIDE COVER	IP20	4M	<input type="checkbox"/> AT antracit anthracite

## OHIŠJE NO CUBO Z DNOM IP20 1M



- AC11PW
- AC11ES
- AC11IW
- AC11AT

- ohišje IP20 1M
- za nadometno pritrditev elementov
- primeren za stikala SM
- ustreza EN 60669-1

*BOX NO CUBO WITH BACK SIDE COVER IP20 1M*  
 - box IP20 1M  
 - for surface mounting of elements  
 - suitable to SM switches  
 - in accordance with EN 60669-1



## OHIŠJE NO CUBO Z DNOM IP20 2M



- AC21PW
- AC21ES
- AC21IW
- AC21AT

- ohišje IP20 2M
- za nadometno pritrditev elementov
- ustreza EN 60669-1, EN60884-1

*BOX NO CUBO WITH BACK SIDE COVER IP20 2M*  
 - box IP20 2M  
 - for surface mounting of elements  
 - in accordance with EN 60669-1, EN60884-1



## OHIŠJE NO CUBO Z DNOM IP20 4M



- AC41PW
- AC41ES
- AC41IW
- AC41AT

- ohišje IP20 4M
- za nadometno pritrditev elementov
- ustreza EN 60669-1, EN60884-1

*BOX NO CUBO WITH BACK SIDE COVER IP20 4M*  
 - box IP20 4M  
 - for surface mounting of elements  
 - in accordance with EN 60669-1, EN60884-1



## OHIŠJE NO CUBO Z DNOM IP20 6M



- AC61PW
- AC61ES
- AC61IW
- AC61AT

- ohišje IP20 6M
- za nadometno pritrditev elementov
- ustreza EN 60669-1, EN60884-1

*BOX NO CUBO WITH BACK SIDE COVER IP20 6M*  
 - box IP20 6M  
 - for surface mounting of elements  
 - in accordance with EN 60669-1, EN60884-1

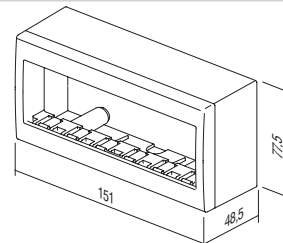
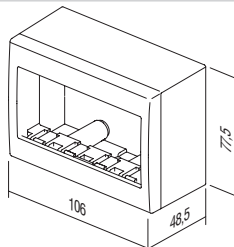
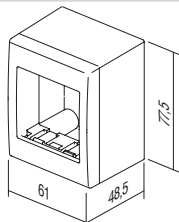
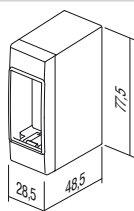

## B O X E S C U B O I P 5 5 A Q



tip type	naziv description	tehnični opis technical data	velikost size	barva colour
AQ20	OHIŠJE NO CUBO OUTDOOR SURFACE MOUNT BOX	IP55	2M	<input type="checkbox"/> PW bela sijaj polar white
AQ22	OHIŠJE NO CUBO OUTDOOR SURFACE MOUNT BOX	IP55	2x2M	<input checked="" type="checkbox"/> GY siva grey
AQ30	OHIŠJE NO CUBO OUTDOOR SURFACE MOUNT BOX	IP55	3M	
AQ31	OHIŠJE PO CUBO OUTDOOR SURFACE MOUNT BOX	IP55	3M	

## OHIŠJE NO CUBO IP55 2M



- AQ20PW
- AQ20GY

- ohišje IP55 2M
- za nadometno pritrditev
- IP55 za vgradnjo v vlažne prostore
- ustreza CEI 23-48, EN 60670

## BOX NO CUBO IP55 2M

- box IP55 2M
- for surface mounting
- IP55 for usage in humid areas
- in accordance with CEI 23-48, EN 60670



## OHIŠJE NO CUBO IP55 2x2M



- AQ22PW
- AQ22GY

- ohišje IP55 2x2M
- za nadometno pritrditev
- IP55 za vgradnjo v vlažne prostore
- ustreza CEI 23-48, EN 60670

## BOX NO CUBO IP55 2x2M

- box IP55 2x2M
- for surface mounting
- IP55 for usage in humid areas
- in accordance with CEI 23-48, EN 60670



## OHIŠJE NO CUBO IP55 3M



- AQ30PW
- AQ30GY

- ohišje IP55 3M
- za nadometno pritrditev
- IP55 za vgradnjo v vlažne prostore
- ustreza CEI 23-48, EN 60670

## BOX NO CUBO IP55 3M

- box IP55 3M
- for surface mounting
- IP55 for usage in humid areas
- in accordance with CEI 23-48, EN 60670



OHIŠJE PO CUBO IP55 2M



- AQ21PW
- AQ21AT

- ohišje IP55 2M
- lahko se kombinira z vsemi funkcijskimi elementi Modul
- za podometno pritrditev
- IP55 za vgradnjo v vlažne prostore
- ustreza CEI 23-48, EN 60670

*BOX PO CUBO IP55 2M*

- box IP55 2M
- can be combined with all Modul functional elements
- for flush mounting
- IP55 for usage in humid areas
- in accordance with CEI 23-48, EN 60670



OHIŠJE PO CUBO IP55 3M



- AQ31PW
- AQ31GY

- ohišje IP55 3M
- za podometno pritrditev
- IP55 za vgradnjo v vlažne prostore
- ustreza CEI 23-48, EN 60670

*BOX PO CUBO IP55 3M*

- box IP55 3M
- for flush mounting
- IP55 for usage in humid areas
- in accordance with CEI 23-48, EN 60670

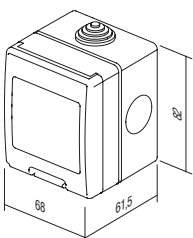

AQ20

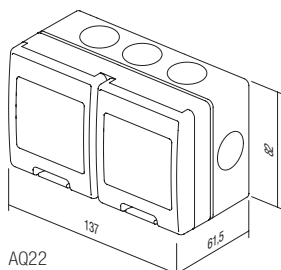

AQ22

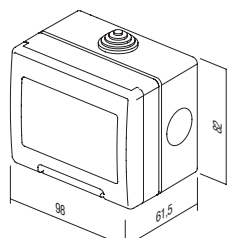

AQ30

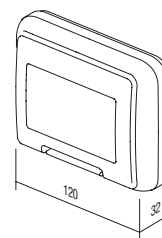

AQ31

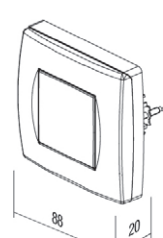

AQ21



## TRUNKING SYSTEM ALUMINIUM

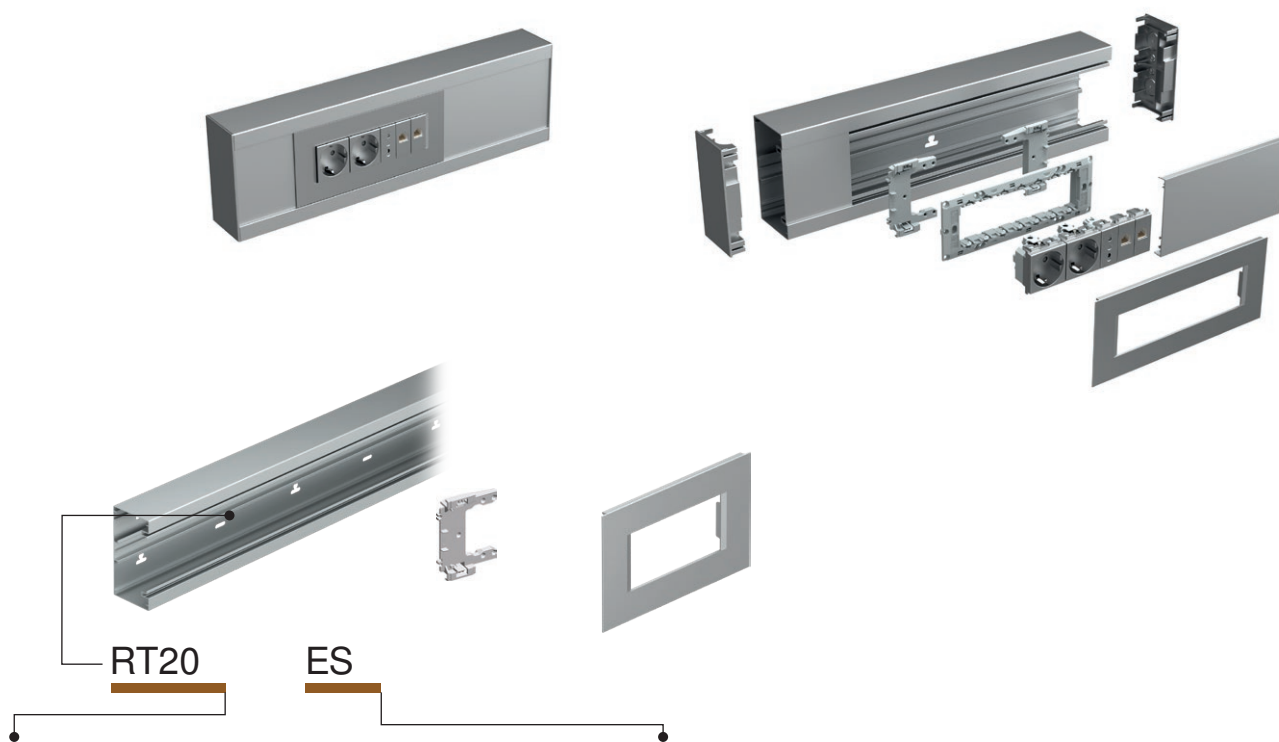

tip type	naziv description	velikost size	barva colour
RT10	ADAPTER MA 92 ADAPTER MA 92	/	■ ES srebrna-mat elox silver-mat
RT12	OKVIR MA 92 COVER PLATE MA 92	2/3M	□ PW bela-mat (RAL 9016) white-mat
RT14	OKVIR MA 92 COVER PLATE MA 92	4M	
⋮	⋮	⋮	

## ADAPTER MA 92



RT10

- adapter za pritrditev nosilcev 2/3M, 4M ali 7M Modul na kanal MA brez doze
- vsak nosilec potrebuje dva adapterja
- ustreza EN 50085-1

## ADAPTER MA 92

- adapter for fixing mounting frames 2/3M, 4M or 7M on MA trunking without box
- each mounting frame needs two adapters
- in accordance with EN 50085-1

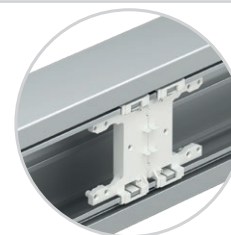

## OKVIR MA 92 2/3M



■ RT12ES  
□ RT12PW

- dekorativni okvir MA 2/3M
- ustreza EN 50085-1

## COVER PLATE MA 92 2/3M

- decorative cover plate MA 2/3M
- in accordance with EN 50085-1

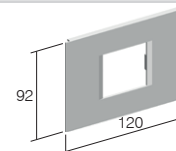

## OKVIR MA 92 4M



■ RT14ES  
□ RT14PW

- dekorativni okvir MA 4M
- ustreza EN 50085-1

## COVER PLATE MA 92 4M

- decorative cover plate MA 4M
- in accordance with EN 50085-1

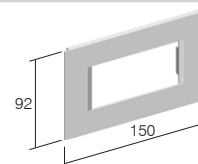

## OKVIR MA 92 7M



■ RT17ES  
□ RT17PW

- dekorativni okvir MA 7M
- ustreza EN 50085-1

## COVER PLATE MA 92 7M

- decorative cover plate MA 7M
- in accordance with EN 50085-1

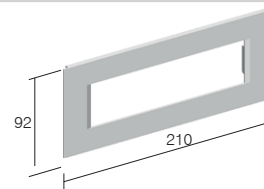

OSNOVA KANALA MA 130x65



- RT20ES
- RT20PW

- osnova kanala iz ekstrudiranega aluminija
- višina 130mm, dolžina 2m
- DIN letev 35mm na dnu
- ustreza EN 50085-1

TRUNKING BASE MA 130x65

- trunking base from extruded aluminium
- height 130mm, length 2m
- DIN - rail 35mm shape on bottom
- in accordance with EN 50085-1

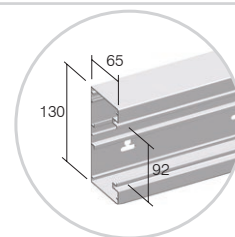

OSNOVA KANALA MA 165x65



- RT21ES
- RT21PW

- osnova kanala iz ekstrudiranega aluminija
- višina 165mm, dolžina 2m
- DIN letev 35mm na dnu
- ustreza EN 50085-1

TRUNKING BASE MA 165x65

- trunking base from extruded aluminium
- height 165mm, length 2m
- DIN - rail 35mm shape on bottom
- in accordance with EN 50085-1

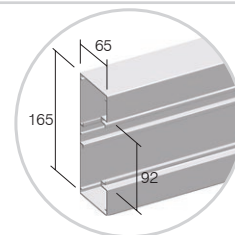

POKROV KANALA MA 92



- RT25ES
- RT25PW

- pokrov kanala iz ekstrudiranega aluminija
- višina 92mm, dolžina 2m
- ustreza EN 50085-1

FRONT COVER MA 92

- front cover from extruded aluminium
- height 92mm, length 2m
- in accordance with EN 50085-1

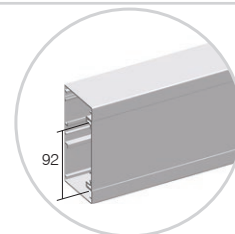

PREGRADA MA 43



RT30

- pregrada kanala iz ekstrudiranega polimera
- globina 43mm, dolžina 2m
- ustreza EN 50085-1

CABLE SHELF MA 43

- cable shelf from extruded polymer
- depth 43mm, length 2m
- in accordance with EN 50085-1

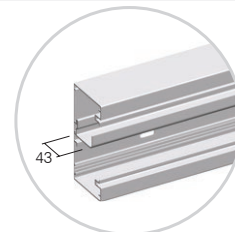

PREGRADA MA 43 AL



RT31

- pregrada kanala iz ekstrudiranega aluminija
- globina 43mm, dolžina 2m
- ustreza EN 50085-1

CABLE SHELF MA 43 AL

- cable shelf from extruded aluminium
- depth 43mm, length 2m
- in accordance with EN 50085-1

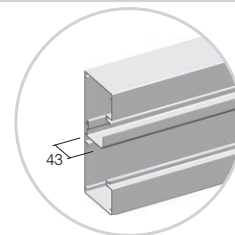

PREGRADA MA 43 AL DVOJNA



RT32

- dvojna pregrada kanala iz ekstrudiranega aluminija
- globina 43mm, dolžina 2m
- ustreza EN 50085-1

CABLE SHELF MA 43 AL DOUBLE

- double cable shelf from extruded aluminium
- depth 43mm, length 2m
- in accordance with EN 50085-1

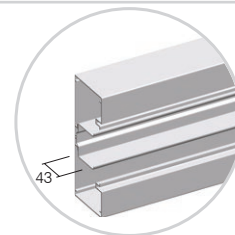

## TRUNKING SYSTEM ALUMINIUM

	<ul style="list-style-type: none"> <li>■ RT35ES</li> <li>□ RT35PW</li> </ul>	<p><b>KONČNI ELEMENT MA 130x65</b></p> <ul style="list-style-type: none"> <li>- končni element iz polimera</li> <li>- višina 130mm</li> <li>- ustreza EN 50085-1</li> </ul> <p><i>STOP END MA 130x65</i></p> <ul style="list-style-type: none"> <li>- stop end element from polymer</li> <li>- height 130mm</li> <li>- in accordance with EN 50085-1</li> </ul>	
	<ul style="list-style-type: none"> <li>■ RT36ES</li> <li>□ RT36PW</li> </ul>	<p><b>KONČNI ELEMENT MA 165x65</b></p> <ul style="list-style-type: none"> <li>- končni element iz kovine</li> <li>- višina 165mm</li> <li>- ustreza EN 50085-1</li> </ul> <p><i>STOP END MA 165x65</i></p> <ul style="list-style-type: none"> <li>- stop end element from metal</li> <li>- height 165mm</li> <li>- in accordance with EN 50085-1</li> </ul>	
	RT38	<p><b>SET RAVNI VEZNI ELEMENT MA 65</b></p> <ul style="list-style-type: none"> <li>- vezni element iz polimera</li> <li>- set vsebuje 2 vezna elementa in vijake</li> <li>- ustreza EN 50085-1</li> </ul> <p><i>SET JOINING PIECE MA 65</i></p> <ul style="list-style-type: none"> <li>- joining piece from polymer</li> <li>- set contains two pieces and screws</li> <li>- in accordance with EN 50085-1</li> </ul>	
	<ul style="list-style-type: none"> <li>■ RT40ES</li> <li>□ RT40PW</li> </ul>	<p><b>UNIVERZALNI KOT MA 130x65</b></p> <ul style="list-style-type: none"> <li>- univerzalni kotni element</li> <li>- višina 130mm</li> <li>- ustreza EN 50085-1</li> </ul> <p><i>UNIVERSAL CORNER MA 130x65</i></p> <ul style="list-style-type: none"> <li>- universal corner element</li> <li>- height 130mm</li> <li>- in accordance with EN 50085-1</li> </ul>	
	<ul style="list-style-type: none"> <li>■ RT41ES</li> <li>□ RT41PW</li> </ul>	<p><b>UNIVERZALNI KOT MA 165x65</b></p> <ul style="list-style-type: none"> <li>- univerzalni kotni element</li> <li>- višina 165mm</li> <li>- ustreza EN 50085-1</li> </ul> <p><i>UNIVERSAL CORNER MA 165x65</i></p> <ul style="list-style-type: none"> <li>- universal corner element</li> <li>- height 165mm</li> <li>- in accordance with EN 50085-1</li> </ul>	
	RT42	<p><b>OZEMLJITVENA SPONKA MA 2x A6.3</b></p> <ul style="list-style-type: none"> <li>- ozemljitvena sponka za ozemljitev osnove in pokrova kanala</li> <li>- ustreza EN 50085-1</li> </ul> <p><i>EARTHING PIECE MA 2x A6.3</i></p> <ul style="list-style-type: none"> <li>- earthing piece for earthing of trunking base and front cover</li> <li>- in accordance with EN 50085-1</li> </ul>	
	<ul style="list-style-type: none"> <li>■ RT43ES</li> <li>□ RT43PW</li> </ul>	<p><b>L KOTNI ELEMENT MA 130x65 / 130</b></p> <ul style="list-style-type: none"> <li>- univerzalni L kotni element iz aluminija</li> <li>- višina 130mm, dolžina 400mm</li> <li>- vezava na MA 130x65</li> <li>- ustreza EN 50085-1</li> </ul> <p><i>L-BEND MA 130x65 / 130</i></p> <ul style="list-style-type: none"> <li>- universal L bend element from aluminium</li> <li>- height 130mm, length 400mm</li> <li>- connection on MA 130x65</li> <li>- in accordance with EN 50085-1</li> </ul>	

L KOTNI ELEMENT MA 165x65 / 130



- RT44ES
- RT44PW

- univerzalni L kotni element iz aluminija
- višina 165mm, dolžina 400mm
- vezava na MA 130x65
- ustreza EN 50085-1

*L-BEND MA 165x65 / 130*

- universal L bend element from aluminium
- height 165mm, length 400mm
- connection on MA 130x65
- in accordance with EN 50085-1

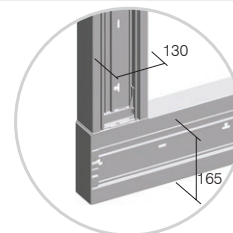

L KOTNI ELEMENT MA 165x65 / 165



- RT47ES
- RT47PW

- univerzalni L kotni element iz aluminija
- višina 165mm, dolžina 400mm
- vezava na MA 165x65
- ustreza EN 50085-1

*L-BEND MA 165x65 / 165*

- universal L bend element from aluminium
- height 165mm, length 400mm
- connection on MA 165x65
- in accordance with EN 50085-1

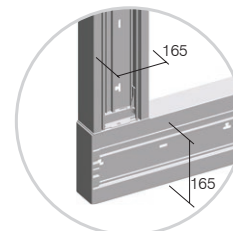

T ELEMENT MA 130x65 / 130



- RT45ES
- RT45PW

- univerzalni T kotni element iz aluminija
- višina 130mm, dolžina 400mm
- vezava na MA 130x65
- ustreza EN 50085-1

*T-BEND MA 130x65 / 130*

- universal T bend element from aluminium
- height 130mm, length 400mm
- connection on MA 130x65
- in accordance with EN 50085-1

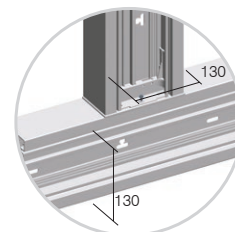

T ELEMENT MA 165x65 / 130

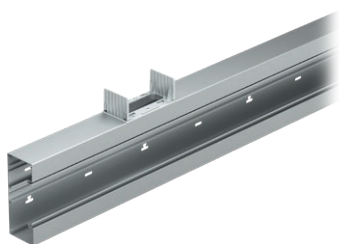

- RT46ES
- RT46PW

- univerzalni T kotni element iz aluminija
- višina 165mm, dolžina 400mm
- vezava na MA 130x65
- ustreza EN 50085-1

*T-BEND MA 165x65 / 130*

- universal T bend element from aluminium
- height 165mm, length 400mm
- connection on MA 130x65
- in accordance with EN 50085-1

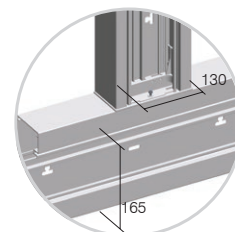

T ELEMENT MA 165x65 / 165



- RT48ES
- RT48PW

- univerzalni T kotni element iz aluminija
- višina 165mm, dolžina 400mm
- vezava na MA 165x65
- ustreza EN 50085-1

*T-BEND MA 165x65 / 165*

- universal T bend element from aluminium
- height 165mm, length 400mm
- connection on MA 165x65
- in accordance with EN 50085-1

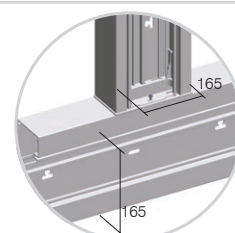

MA je modularni sistem za velikosti: 2M, 4M, 7M

*MA trunking is based on modular system making 2M, 4M or 7M combinations of elements*

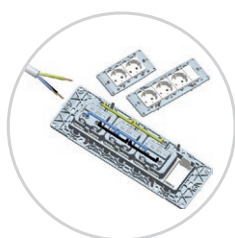

Modul vsebuje tudi elemente pripravljene za hitro montažo

*In Modul we provide special elements for quick installation*

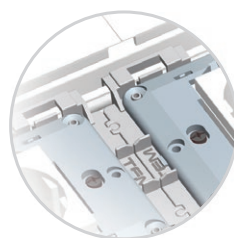

Adapter MA omogoča natančno pozicioniranje na rob kanala

*With Adapter MA exact positioning without extra effort is provided*

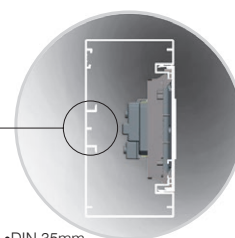

Montaža brez doze pomeni več prostora za kable, DIN letev oblika EN-60715

*Mounted without box means more space for cables, DIN-rail base shape EN-60715*

# TRUNKING SYSTEM ALUMINIUM



## NOSILEC STEBRIČKA MA ENOJNI 130x65

- RT50ES
- RT50PW

- nosilec za pritrnitev kanala MA130 v tla in/ali v strop prostora  
- ustreza EN 50085-1

### FIXING PLATE MA SINGLE 130x65

- fixing plate for fixing trunking base MA130 on the floor and/or on the ceiling  
- in accordance with EN 50085-1



- RT51ES
- RT51PW

## NOSILEC STEBRIČKA MA DVOJNI 130x65

- nosilec za pritrnitev dveh kanalov MA130 v tla in/ali v strop prostora  
- ustreza EN 50085-1

### FIXING PLATE MA DOUBLE 130x65

- fixing plate for fixing two trunking bases MA130 on the floor and/or on the ceiling  
- in accordance with EN 50085-1



## STEBRIČEK MA 130x65x500

- RT52ES
- RT52PW

- instalacijski stebriček MA  
- višina 500mm  
- nosilec 7M vgrajen  
- ustreza EN 50085-1

### SERVICE POST MA 130x65x500

- service post MA  
- height 500mm  
- mounting frame 7M included  
- in accordance with EN 50085-1

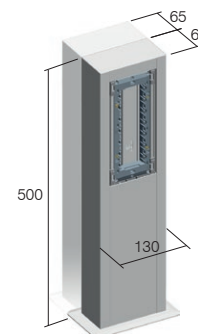

## STEBRIČEK MA DVOJNI 130x130x500

- RT53ES
- RT53PW

- instalacijski stebriček MA dvojni  
- višina 500mm  
- nosilca 7M vgrajena  
- ustreza EN 50085-1

### SERVICE POST MA DOUBLE 130x130x500

- service post MA double  
- height 500mm  
- mounting frames 7M included  
- in accordance with EN 50085-1

Presek vodnika / Cable intersection mm <sup>2</sup>	Uporabni presek kablov / Cable cross-section (mm <sup>2</sup> )				
	1 vodnik / 1 wire	2 vodnika / 2 wires	3 vodniki / 3 wires	4 vodniki / 4 wires	5 vodnikov / 5 wires
1,5	44	111	121	144	169
2,5	49	133	157	169	211
4	58	169	183	211	256
6	68	196	225	256	307

Kapaciteta kanala / Trunk capacity				
kanal / Trunk	MA 130x65 prazen / empty	MA 130x65 z Modul opremo / with Modul switches and sockets	MA 165x65 prazen / empty	MA 130x65 z Modul opremo / with Modul switches and sockets
kapaciteta capacity	7600 mm <sup>2</sup>	5500 mm <sup>2</sup>	9900 mm <sup>2</sup>	7800 mm <sup>2</sup>
max ø	54 mm	2x42 mm	54 mm	2x42 mm

# TALNE DOZE MT

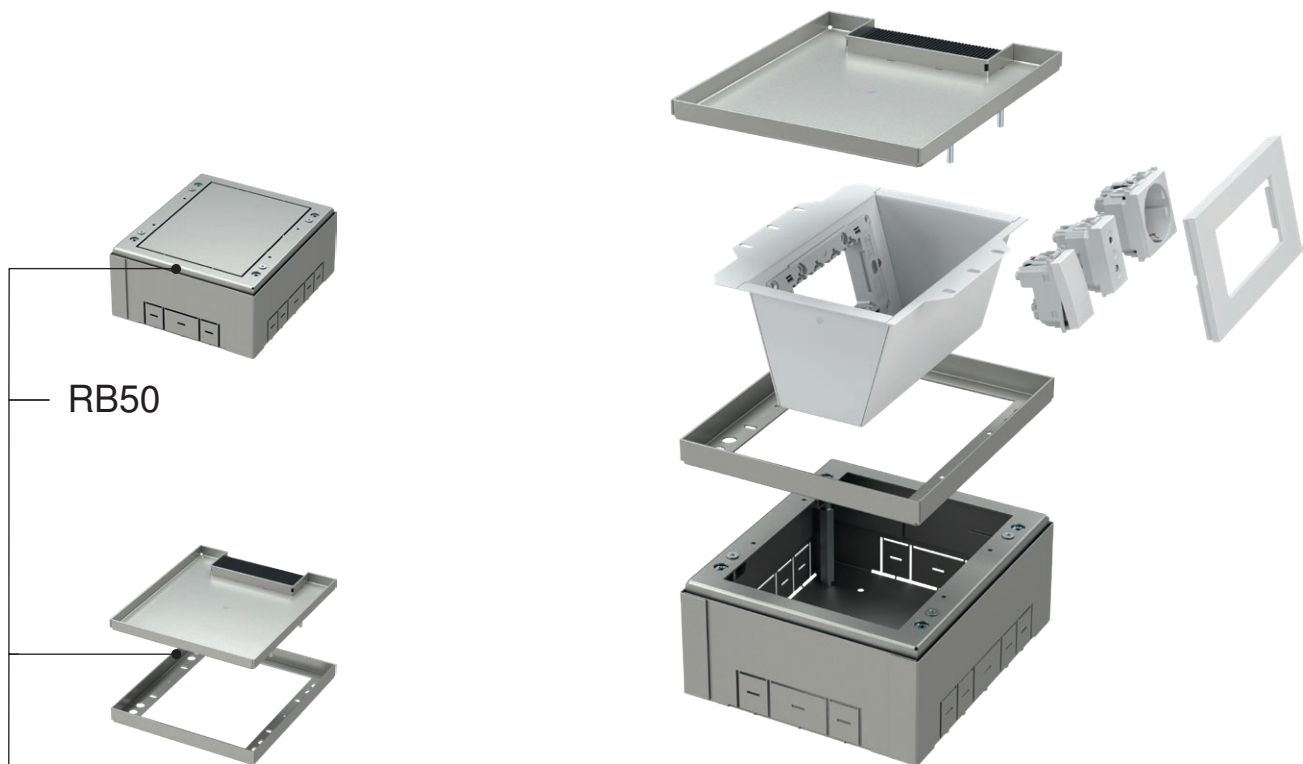

tip type	naziv description	tehnični opis technical data
RB50	VGRADNO OHIŠJE TALNE DOZE FLOOR BOX BASE	4M
RB65S1	POKROV TALNE DOZE FLOOR DISTRIBUTION BOX COVER	4M
RB60	VLOŽEK TALNE DOZE INSERT FOR FLOOR DISTRIBUTION BOX	4M
.	.	.
.	.	.

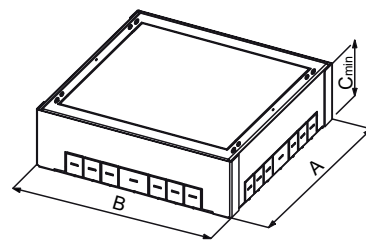
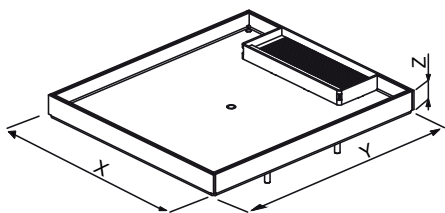

	RB65S1	RB66S1	RB67S2	RB68S2
X	177	178	265	516,5
Y	200,5	265	265	265
Z	17,5	17,5	17,5	17,5

	RB50	RB51	RB52	RB53
A	208,5	273	273	273
B	182	182,5	269,5	521
C min	83	83	83	83

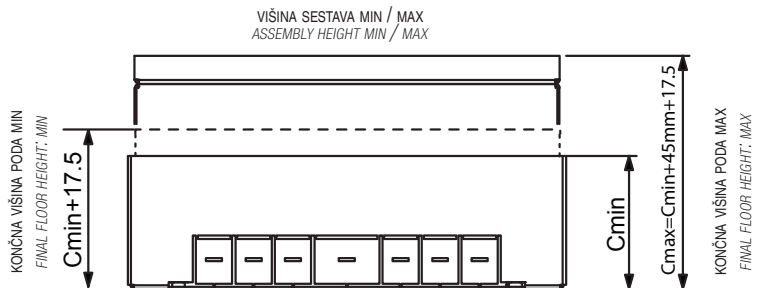

## F L O O R   B O X E S   M T

## VGRADNO OHIŠJE TALNE DOZE 4M



RB50

- vgradno ohišje 4M
- kovinsko, cinkano
- za vgradnjo v tlak ali dvojni pod
- vgradne mere 208,5 x 182 mm, globina min 83 mm
- nastavljiva višina 83–128 mm
- ustreza EN 5005-1 in EN 50085-2-2

*FLOOR BOX BASE 4M*

- floor box base 4M
- metal, galvanized
- for installation in a floor or double floor
- mounting dimensions 208.5x182mm, min. depth 83mm
- adjustable height 83-128mm
- in accordance with EN 5005-1 and EN 50085-2-2

## VLOŽEK TALNE DOZE 4M



RB60

- vložek talne doze 4M
- kovinski, barva bela RAL 9006
- nosilec MODUL 4M vgrajen
- ustreza EN 5005-1 in EN 50085-2-2

*INSERT FOR FLOOR DISTRIBUTION BOX 4M*

- insert for floor box 4M
- metal, colour white RAL 9006
- mounting frame MODUL 4M included
- in accordance with EN 5005-1 and EN 50085-2-2

## POKROV TALNE DOZE 4M



RB65S1

- pokrov doze 4M
- kovinski, cinkan
- vgradne mere 200,5 x 177 mm, globina 17,5 mm
- debelina talne obloge pokrova do 11,5 mm
- ustreza EN 5005-1 in EN 50085-2-2

*FLOOR DISTRIBUTION BOX COVER 4M*

- floor box cover 4M
- metal, galvanized
- mounting dimensions 200.5x177mm, depth 17.5mm
- floor thickness up to 11.5mm
- in accordance with EN 5005-1 and EN 50085-2-2

## VGRADNO OHIŠJE TALNE DOZE 7M



RB51

- vgradno ohišje 7M
- kovinsko, cinkano
- za vgradnjo v tlak ali dvojni pod
- vgradne mere 273 x 182,5 mm, globina min 83 mm
- nastavljiva višina 83–128 mm
- ustreza EN 5005-1 in EN 50085-2-2

*FLOOR BOX BASE 7M*

- floor box base 7M
- metal, galvanized
- for installation in a floor or double floor
- mounting dimensions 273x182.5mm, min. depth 83mm
- adjustable height 83-128mm
- in accordance with EN 5005-1 and EN 50085-2-2

## VLOŽEK TALNE DOZE 7M



RB61

- vložek talne doze 7M
- kovinski, barva bela RAL 9006
- nosilec MODUL 7M vgrajen
- ustreza EN 5005-1 in EN 50085-2-2

*INSERT FOR FLOOR DISTRIBUTION BOX 7M*

- insert for floor box 7M
- metal, colour white RAL 9006
- mounting frame MODUL 7M included
- in accordance with EN 5005-1 and EN 50085-2-2

## POKROV TALNE DOZE 7M



RB66S1

- pokrov doze 7M
- kovinski, cinkan
- vgradne mere 265 x 178 mm, globina 17,5 mm
- debelina talne obloge pokrova do 11,5 mm
- ustreza EN 5005-1 in EN 50085-2-2

*FLOOR DISTRIBUTION BOX COVER 7M*

- floor box cover 7M
- metal, galvanized
- mounting dimensions 265x178mm, depth 17.5mm
- floor thickness up to 11.5mm
- in accordance with EN 5005-1 and EN 50085-2-2

## VGRADNO OHIŠJE TALNE DOZE 2X7M



RB52

- vgradno ohišje 2 x 7M
- kovinsko, cinkano
- za vgradnjo v tlak ali dvojni pod
- vgradne mere 273 x 269,5 mm, globina min 83 mm
- nastavljiva višina 83–128 mm
- ustreza EN 5005-1 in EN 50085-2-2

## FLOOR BOX BASE 2X7M

- floor box base 2X7M
- metal, galvanized
- for installation in a floor or double floor
- mounting dimensions 273x269.5mm, min. depth 83mm
- adjustable height 83-128mm
- in accordance with EN 5005-1 and EN 50085-2-2

## VLOŽEK TALNE DOZE 2X7M



RB62

- vložek talne doze 2 x 7M
- kovinski, barva bela RAL 9006
- nosilca MODUL 2 x 7M vgrajena
- ustreza EN 5005-1 in EN 50085-2-2

## INSERT FOR FLOOR DISTRIBUTION BOX 2X7M

- insert for floor box 2x7M
- metal, colour white RAL 9006
- mounting frames MODUL 2x7M included
- in accordance with EN 5005-1 and EN 50085-2-2

## POKROV TALNE DOZE 2X7M



RB67S2

- pokrov doze 2 X 7M
- kovinski, cinkan
- vgradne mere 265 x 265 mm, globina 17,5 mm
- debelina talne obloge pokrova do 11,5 mm
- ustreza EN 5005-1 in EN 50085-2-2

## FLOOR DISTRIBUTION BOX COVER 2X7M

- floor box cover 2x7M
- metal, galvanized
- mounting dimensions 265x265mm, depth 17.5mm
- floor thickness up to 11.5mm
- in accordance with EN 5005-1 and EN 50085-2-2

## VGRADNO OHIŠJE TALNE DOZE 4X7M

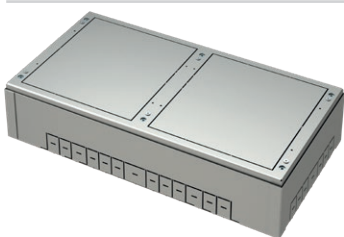

RB53

- vgradno ohišje 4 x 7M
- kovinsko, cinkano
- za vgradnjo v tlak ali dvojni pod
- vgradne mere 273 x 521 mm, globina min 83 mm
- nastavljiva višina 83–128 mm
- ustreza EN 5005-1 in EN 50085-2-2

## FLOOR BOX BASE 4X7M

- floor box base 4X7M
- metal, galvanized
- for installation in a floor or double floor
- mounting dimensions 273x521mm, min. depth 83mm
- adjustable height 83-128mm
- in accordance with EN 5005-1 and EN 50085-2-2

## VLOŽEK TALNE DOZE 2X7M



RB62

- vložek talne doze 2 x 7M
- kovinski, barva bela RAL 9006
- nosilca MODUL 2 x 7M vgrajena
- ustreza EN 5005-1 in EN 50085-2-2

## INSERT FOR FLOOR DISTRIBUTION BOX 2X7M

- insert for floor box 2x7M
- metal, colour white RAL 9006
- mounting frames MODUL 2x7M included
- in accordance with EN 5005-1 and EN 50085-2-2

## POKROV TALNE DOZE 4X7M



RB68S2

- pokrov doze 4 X 7M
- kovinski, cinkan
- vgradne mere 265 x 516,5 mm, globina 17,5 mm
- debelina talne obloge pokrova do 11,5 mm
- ustreza EN 5005-1 in EN 50085-2-2

## FLOOR DISTRIBUTION BOX COVER 4X7M

- floor box cover 4x7M
- metal, galvanized
- mounting dimensions 265x516.5mm, depth 17.5mm
- floor thickness up to 11.5mm
- in accordance with EN 5005-1 and EN 50085-2-2



## F L O O R   B O X E S   M T



RB55S1

tip type	naziv description	tehnični opis technical data
RB55S1	TALNA DOZA ZA DVOJNA TLA S POKROVOM FLOOR BOX WITH COVER FOR DOUBLE FLOORS	4M
RB60	VLOŽEK TALNE DOZE INSERT FOR FLOOR DISTRIBUTION BOX	4M
⋮	⋮	⋮
⋮	⋮	⋮

	RB55S1	RB56S1	RB57S2	RB58S2
A	200,5	265	265	265
B	177	178	265	516,5
C min	100	100	100	100

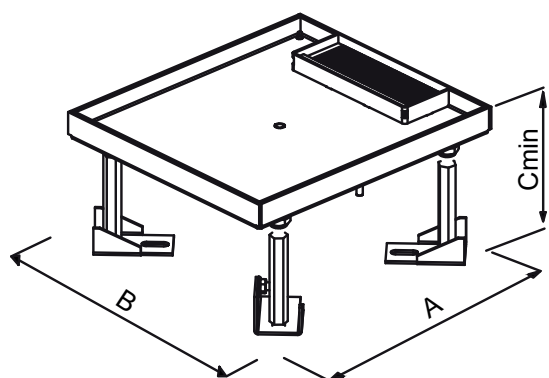

KONČNA VIŠINA PODA: MIN  
FINAL FLOOR HEIGHT: MIN

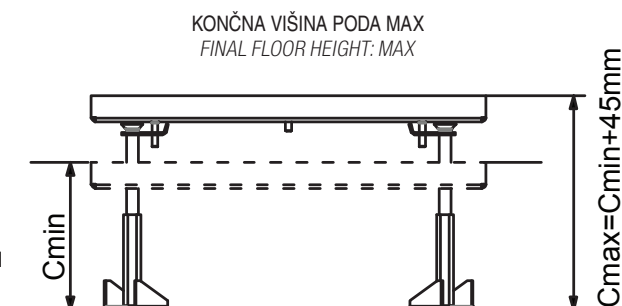

KONČNA VIŠINA PODA MAX  
FINAL FLOOR HEIGHT: MAX

## TALNA DOZA ZA DVOJNA TLA S POKROVOM 4M



RB55S1

- talna doza za dvojna tla 4M
- kovinska, cinkana
- vgradne mere 200,5 x 177 mm, globina min 100 mm
- nastavljiva višina 100–145 mm
- debelina talne obloge pokrova do 11,5 mm
- ustreza EN 5005-1 in EN 50085-2-2

## FLOOR BOX WITH COVER FOR DOUBLE FLOORS 4M

- floor box base 4M
- metal, galvanized
- mounting dimensions 200.5x177mm, min. depth 100mm
- adjustable height 100-145mm
- floor thickness up to 11.5mm
- in accordance with EN 5005-1 and EN 50085-2-2

## VLOŽEK TALNE DOZE 4M



RB60

- vložek talne doze 4M
- kovinski, barva bela RAL 9006
- nosilec MODUL 4M vgrajen
- ustreza EN 5005-1 in EN 50085-2-2

## INSERT FOR FLOOR DISTRIBUTION BOX 4M

- insert for floor box 4M
- metal, colour white RAL 9006
- mounting frame MODUL 4M included
- in accordance with EN 5005-1 and EN 50085-2-2

## TALNA DOZA ZA DVOJNA TLA S POKROVOM 7M



RB56S1

- talna doza za dvojna tla 7M
- kovinska, cinkana
- vgradne mere 265 x 178 mm, globina min 100 mm
- nastavljiva višina 100–145 mm
- debelina talne obloge pokrova do 11,5 mm
- ustreza EN 5005-1 in EN 50085-2-2

*FLOOR BOX WITH COVER FOR DOUBLE FLOORS 7M*

- floor box base 7M
- metal, galvanized
- mounting dimensions 265x178mm, min. depth 100mm
- adjustable height 100-145mm
- floor thickness up to 11.5mm
- in accordance with EN 5005-1 and EN 50085-2-2

## VLOŽEK TALNE DOZE 7M



RB61

- vložek talne doze 7M
- kovinski, barva bela RAL 9006
- nosilec MODUL 7M vgrajen
- ustreza EN 5005-1 in EN 50085-2-2

*INSERT FOR FLOOR DISTRIBUTION BOX 7M*

- insert for floor box 7M
- metal, colour white RAL 9006
- mounting frame MODUL 7M included
- in accordance with EN 5005-1 and EN 50085-2-2

## TALNA DOZA ZA DVOJNA TLA S POKROVOM 2X7M



RB57S2

- talna doza za dvojna tla 2 x 7M
- kovinska, cinkana
- vgradne mere 265 x 265 mm, globina min 100 mm
- nastavljiva višina 100–145 mm
- debelina talne obloge pokrova do 11,5 mm
- ustreza EN 5005-1 in EN 50085-2-2

*FLOOR BOX WITH COVER FOR DOUBLE FLOORS 2X7M*

- floor box base 2x7M
- metal, galvanized
- mounting dimensions 265x265mm, min. depth 100mm
- adjustable height 100-145mm
- floor thickness up to 11.5mm
- in accordance with EN 5005-1 and EN 50085-2-2

## VLOŽEK TALNE DOZE 2X7M



RB62

- vložek talne doze 2 x 7M
- kovinski, barva bela RAL 9006
- nosilca MODUL 2 x 7M vgrajena
- ustreza EN 5005-1 in EN 50085-2-2

*INSERT FOR FLOOR DISTRIBUTION BOX 2X7M*

- insert for floor box 2x7M
- metal, colour white RAL 9006
- mounting frames MODUL 2x7M included
- in accordance with EN 5005-1 and EN 50085-2-2

## TALNA DOZA ZA DVOJNA TLA S POKROVOM 4X7M



RB58S2

- talna doza za dvojna tla 4 x 7M
- kovinska, cinkana
- vgradne mere 265 x 516,5 mm, globina min 100 mm
- nastavljiva višina 100–145 mm
- debelina talne obloge pokrova do 11,5 mm
- ustreza EN 5005-1 in EN 50085-2-2

*FLOOR BOX WITH COVER FOR DOUBLE FLOORS 4X7M*

- floor box base 4x7M
- metal, galvanized
- mounting dimensions 265x516.5mm, min. depth 100mm
- adjustable height 100-145mm
- floor thickness up to 11.5mm
- in accordance with EN 5005-1 and EN 50085-2-2

## VLOŽEK TALNE DOZE 2X7M

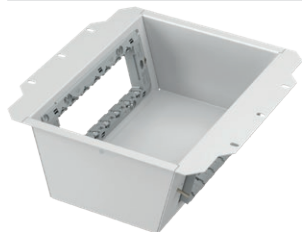

RB62

- vložek talne doze 2 x 7M
- kovinski, barva bela RAL 9006
- nosilca MODUL 2 x 7M vgrajena
- ustreza EN 5005-1 in EN 50085-2-2

*INSERT FOR FLOOR DISTRIBUTION BOX 2X7M*

- insert for floor box 2x7M
- metal, colour white RAL 9006
- mounting frames MODUL 2x7M included
- in accordance with EN 5005-1 and EN 50085-2-2

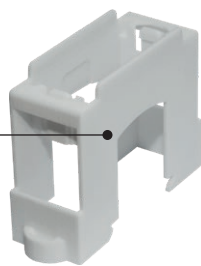
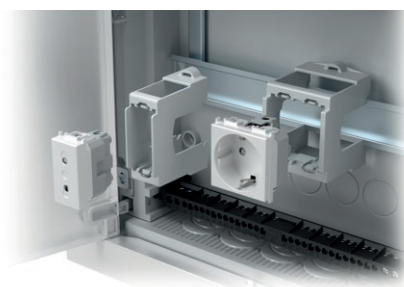
**RB10**

tip type	naziv description	tehnični opis technical data
RB10	ADAPTER ZA DIN LETEV <i>ADAPTER FOR DIN RAIL</i>	35mm 1M
RB11	ADAPTER ZA DIN LETEV <i>ADAPTER FOR DIN RAIL</i>	35mm 2M
⋮	⋮	⋮

**ADAPTER ZA DIN LETEV 35mm 1M**

**RB10**

- adapter MODUL 1M
- za DIN letev 35mm
- ustreza EN 50022

**ADAPTER FOR DIN RAIL 35mm 1M**

- adapter MODUL 1M
- for DIN rail 35mm
- in accordance with EN 50022

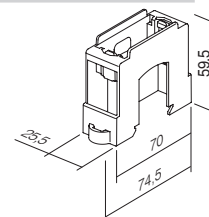

**ADAPTER ZA DIN LETEV 35mm 2M**

**RB11**

- adapter MODUL 2M
- za DIN letev 35mm
- ustreza EN 50022

**ADAPTER FOR DIN RAIL 35mm 2M**

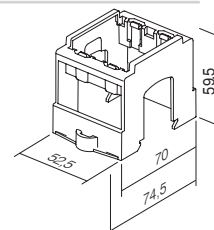
- adapter MODUL 2M
- for DIN rail 35mm
- in accordance with EN 50022



TEM

SWITCH  
LOGIQ



LOGIQ

LOGIQ  
FLAT



LOGIQ  
BOLD



LOGIQ  
PRIME



LOGIQ  

---

FLAT





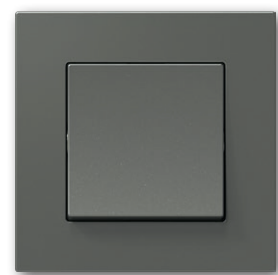

LOGIQ  

---

B O L D





LOGIQ  

---

PRIME



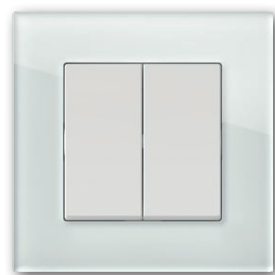

## Narejen za vsak prostor

**Univerzalne linije stikal pustijo svoj pečat v modernih delovnih okoljih ali v bolj domačih toplih bivalnih prostorih. Za vsako vašo željo vam družina stikal LOGIQ ponuja preprosto in logično rešitev.**

*Made for every room*

*The switches have universal lines that make a mark in both modern work environments and cosy, comfortable living spaces. The LOGIQ family of switches offers a simple and logical solution for your every wish.*

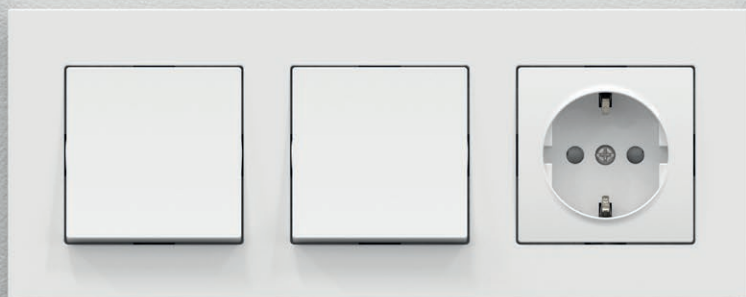

LOGIQ  
FLAT



LOGIQ  
PRIME

## Harmonija barv za vsak prostor

Družino LOGIQ odlikuje logičen izbor preverjenih in elegantnih barvnih odtenkov, ki jih imajo uporabniki najraje. Ne prilagajajte se vi, LOGIQ se prilagaja vam.

*Harmony of colours for every room*

*The LOGIQ family prides itself on its logical range of verified and elegant hues known and loved by our users. Do not compromise, LOGIQ has you covered.*

■ črna	<i>black</i>
■ antracit	<i>anthracite</i>
■ titan	<i>titanium</i>
□ bela-sijaj	<i>polar white</i>





LOGIQ  
FLAT



LOGIQ  
BOLD



LOGIQ  
PRIME

## Neomejena domišljija

Družina LOGIQ omogoča sestavljanje poljubnih kombinacij. Za enostavno kombiniranje smo za vas izdelali uporabno dopolnitev, ki olajša nizanje vodoravnih in navpičnih linij. Tako imenovani sistem 55/55 omogoča uporabo enakih univerzalnih elementov.

### LIMITLESS IMAGINATION

*The LOGIQ family allows you to create your own combinations. To make combining simple, we have created a useful system that supports the sequencing of horizontal and vertical lines. The so-called 55/55 system allows you to use the same universal elements every time.*



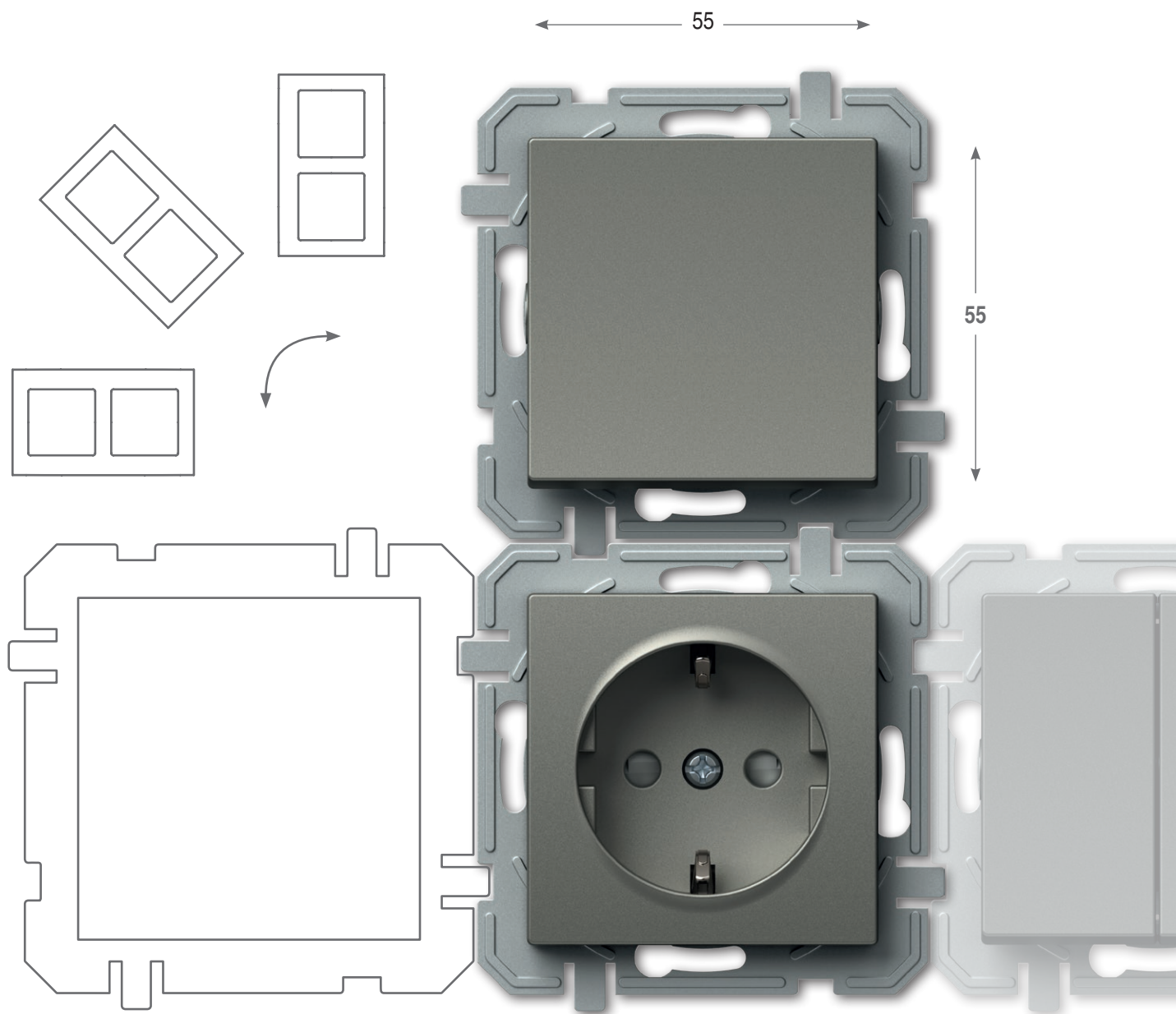

## Preprosto za najzahtevnejše

Družina LOGIQ ponuja funkcijske elemente za vsak prostor in namen. Lahko jih uporabite posamično ali v nizu. Vodoravno ali navpično. Logično.

### *Simple for the most demanding*

*The LOGIQ family offers functional elements for every space and purpose. You can use these products individually or in a sequence, horizontally or vertically. Logically.*

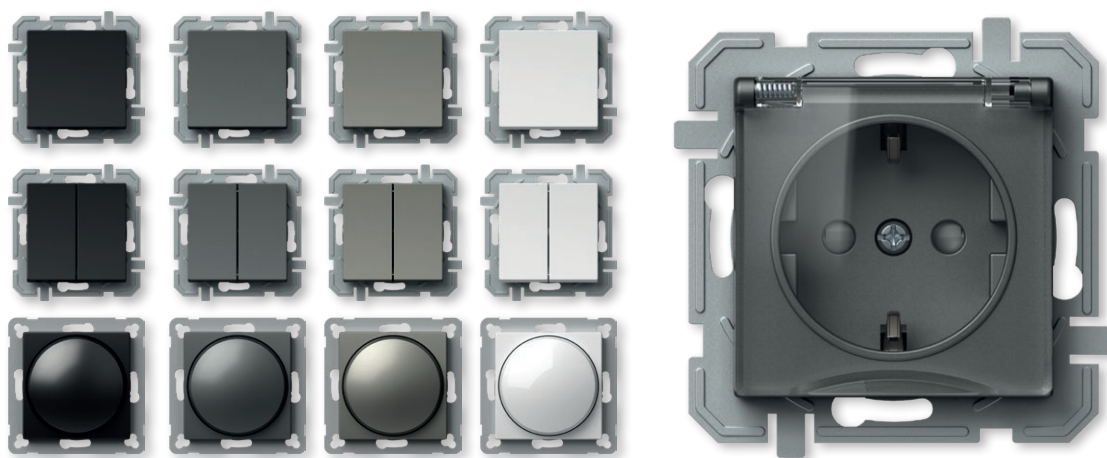

**Univerzalna postavitev dekorativnih okvirjev vseh treh oblikovnih linij FLAT, BOLD in PRIME.**

*A universal layout of decorative cover plates in all three design lines – FLAT, BOLD and PRIME.*



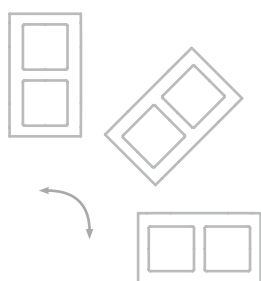

## Logična montaža

LOGIQ je rešitev za sistem standardnih okroglih doz. Z njim lahko načrtujete tako enostavne kot tudi zahtevnejše inštalacije, novogradnje in adaptacije. Sistem odlikujejo brezvijačni kontakti, ki vam prihranijo čas pri vgradnji elementov.

### *Logical installation*

*LOGIQ is a solution for the system of standardized round installations boxes. It can be used for simple as well as more demanding installations, new buildings and adaptations. The system is characterised by plug-in contacts which save time during installation of elements.*

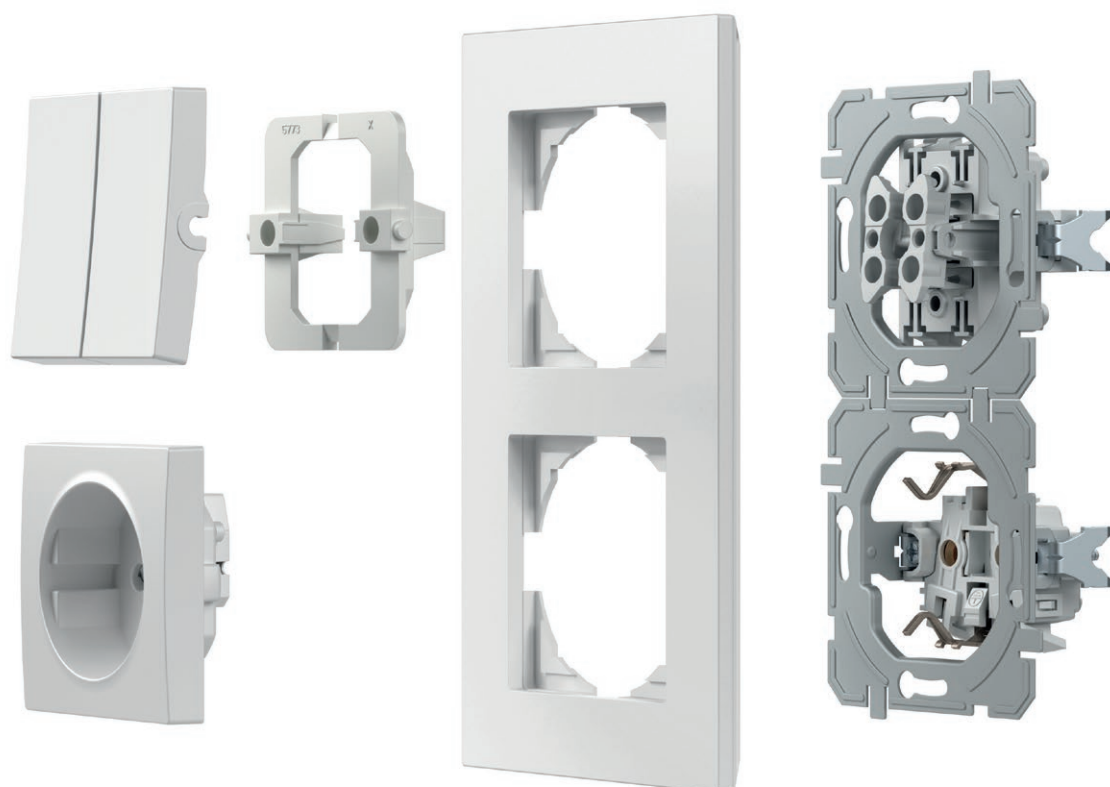

## Dobro je vedeti

*Good to know*



Vse vtičnice imajo vgrajeno varovalo pred dotikom elementov pod napetostjo.

*All the sockets are equipped with a safety shutters assuring the protection to live contacts.*



Dobro premišljena konstrukcija stikala omogoča enostavno indikacijo tudi naknadno.

*The well-thought-out design of the switch enables the easy integration of the indication, including at a later time.*



Za zanesljivost preklopa skrbijo kontakti iz srebrove zlitine.

*Contacts made of silver alloy guarantee safe switching.*



Brezvijačni kontakti omogočajo hitro in zanesljivo priključitev vodnikov. Na isti kontakt lahko pritrdite dva vodnika različnih premerov.

*Plug-in contacts enable quick and reliable attachment of wires. Two wires of different diameters can be attached to the same contact.*



Krepeljci omogočajo globljo pritrditev (tudi preko keramičnih ploščic ipd.).





*Fixing claws enable deeper fixing (also through ceramic tiles, etc.)*

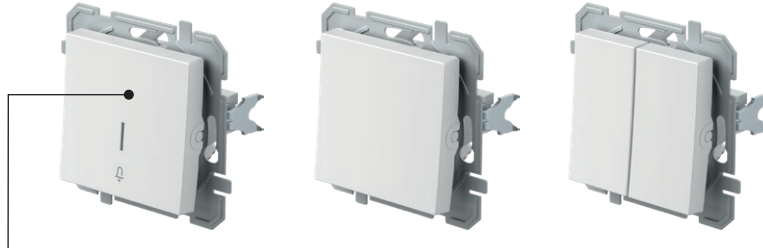

Sestavljive doze vam bodo olajšale delo. Prave razdalje so vam zagotovljene.

*Easy-fitting installation boxes will make your work easier. Proper lengths are guaranteed.*



tip type	naziv description	tehnični opis technical data	barva colour	opcijski opis 1 optional data 1	opcijski opis 2 optional data 2	opcijski opis 3 optional data 3
SQ10	STIKALO ENOPOLNO SWITCH 1WAY	10AX 250V~	<input type="checkbox"/> PW bela - sijaj polar white	 NT nevtral neutral	 01	XO brez okvirja without cover plate
SQ11	TIPKALO ENOPOLNO PUSH BUTTON 1WAY	10A 250V~	<input type="checkbox"/> TI titan titanium	 IN indikator indicator	 02	
SQ22	STIKALO DVOPOLNO SWITCH 2POLE	16AX 250V~	<input type="checkbox"/> AT antracit anthracite <input type="checkbox"/> BK črna black		 03	
...	...	...			...	

STIKALO ENOPOLNO 10AX 250V~

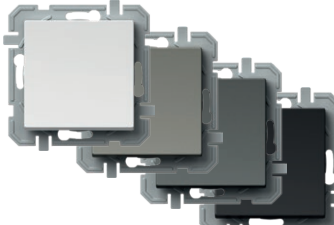

- SQ10PWXO
- SQ10TIXO
- SQ10ATXO
- SQ10BKXO

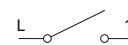
L  1

- 10AX 250V~, tip SQ10
- ustreza EN 60669-1
- brezvijačna pritrditev vodnikov 1.5-2.5mm<sup>2</sup>

*SWITCH 1WAY 10AX 250V~*  
 - 10AX 250V~, type SQ10  
 - in accordance with EN 60669-1  
 - plug-in contacts 1.5-2.5mm<sup>2</sup>



STIKALO ENOPOLNO 10AX 250V~ \_\_ IN

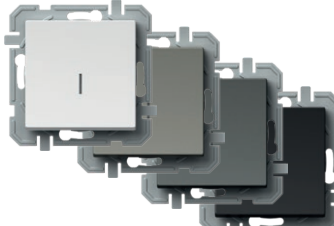

- SQ10PWINXO
- SQ10TIINXO
- SQ10ATINXO
- SQ10BKINXO

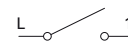
L  1

- IN indikator, brez tlivke
- 10AX 250V~, tip SQ10
- ustreza EN 60669-1
- brezvijačna pritrditev vodnikov 1.5-2.5mm<sup>2</sup>

*SWITCH 1WAY 10AX 250V~ \_\_ IN*  
 - IN indicator, without neon lamp  
 - 10AX 250V~, type SQ10  
 - in accordance with EN 60669-1  
 - plug-in contacts 1.5-2.5mm<sup>2</sup>



TIPKALO ENOPOLNO 10A 250V~



- SQ11PWXO
- SQ11TIXO
- SQ11ATXO
- SQ11BKXO

L  1

- 10A 250V~, tip SQ11
- ustreza EN 60669-1
- brezvijačna pritrditev vodnikov 1.5-2.5mm<sup>2</sup>

*PUSH BUTTON 1WAY 10A 250V~*  
 - 10A 250V~, type SQ11  
 - in accordance with EN 60669-1  
 - plug-in contacts 1.5-2.5mm<sup>2</sup>



TIPKALO ENOPOLNO 10A 250V~ \_\_ IN 01



- SQ11PWIN01XO
- SQ11TIIN01XO
- SQ11ATIN01XO
- SQ11BKIN01XO

L  1

- IN 01 indikator zvonec, brez tlivke
- 10A 250V~, tip SQ11
- ustreza EN 60669-1
- brezvijačna pritrditev vodnikov 1.5-2.5mm<sup>2</sup>

*PUSH BUTTON 1WAY 10A 250V~ \_\_ IN 01*  
 - IN 01 indicator bell, without neon lamp  
 - 10A 250V~, type SQ11  
 - in accordance with EN 60669-1  
 - plug-in contacts 1.5-2.5mm<sup>2</sup>





## S W I T C H E S S Q

## TIPKALO ENOPOLNO 10A 250V~ \_\_ IN 02



- SQ11PWIN02XO
- SQ11TIIN02XO
- SQ11ATIN02XO
- SQ11BKIN02XO

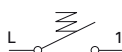

- IN 02 indikator luč, brez tlivke
- 10A 250V~, tip SQ11
- ustreza EN 60669-1
- brezvijačna pritrditev vodnikov 1.5-2.5mm<sup>2</sup>

## PUSH BUTTON 1WAY 10A 250V~ \_\_ IN 02

- IN 02 indicator light, without neon lamp
- 10A 250V~, type SQ11
- in accordance with EN 60669-1
- plug-in contacts 1.5-2.5mm<sup>2</sup>



## TIPKALO ENOPOLNO 10A 250V~ \_\_ IL



- SQ11PWILXO
- SQ11TIILXO
- SQ11ATILXO
- SQ11BKILXO

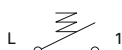

- IL napisna ploščica
- 10A 250V~, tip SQ11
- ustreza EN 60669-1
- brezvijačna pritrditev vodnikov 1.5-2.5mm<sup>2</sup>

## PUSH BUTTON 1WAY 10A 250V~ \_\_ IL

- IL inscription plate
- 10A 250V~, type SQ11
- in accordance with EN 60669-1
- plug-in contacts 1.5-2.5mm<sup>2</sup>



## STIKALO DVOPOLNO 16AX 250V~ \_\_ IN 03



- SQ22PWIN03XO
- SQ22TIIN03XO
- SQ22ATIN03XO
- SQ22BKIN03XO

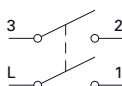

- IN 03 nevtral 0-1, brez tlivke
- 16AX 250V~, tip SQ22
- ustreza EN 60669-1
- vijajna pritrditev vodnikov 1.5-2.5mm<sup>2</sup>

## SWITCH 2POLE 16AX 250V~ \_\_ IN 03

- IN 03 neutral 0-1, without neon lamp
- 16AX 250V~, type SQ22
- in accordance with EN 60669-1
- screw contacts 1.5-2.5mm<sup>2</sup>



## STIKALO SERIJSKO 10AX 250V~



- SQ50PWXO
- SQ50TIXO
- SQ50ATXO
- SQ50BKXO

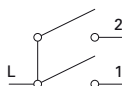

- 10AX 250V~, tip SQ50
- ustreza EN 60669-1
- brezvijačna pritrditev vodnikov 1.5-2.5mm<sup>2</sup>

## SWITCH 2GANG-1WAY 10AX 250V~

- 10AX 250V~, type SQ50
- in accordance with EN 60669-1
- plug-in contacts 1.5-2.5mm<sup>2</sup>



## TIPKALO SERIJSKO 10A 250V~



- SQ51PWXO
- SQ51TIXO
- SQ51ATXO
- SQ51BKXO

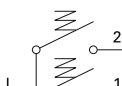

- 10A 250V~, tip SQ51
- ustreza EN 60669-1
- brezvijačna pritrditev vodnikov 1.5-2.5mm<sup>2</sup>

## PUSH BUTTON 2GANG-1WAY 10A 250V~

- 10A 250V~, type SQ51
- in accordance with EN 60669-1
- plug-in contacts 1.5-2.5mm<sup>2</sup>



## STIKALO ŽALUZIJSKO 10AX 250V~ \_\_ NT 09



- SQ52PWNT09XO
- SQ52TINT09XO
- SQ52ATNT09XO
- SQ52BKNT09XO

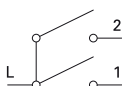

- NT 09 nevtral gor-dol
- 10AX 250V~, tip SQ52
- ustreza EN 60669-1
- brezvijačna pritrditev vodnikov 1.5-2.5mm<sup>2</sup>
- z mehansko blokado hkratnega vklopa

## SWITCH SHUTTERS 10AX 250V~ \_\_ NT 09

- NT 09 neutral up-down
- 10AX 250V~, type SQ52
- in accordance with EN 60669-1
- plug-in contacts 1.5-2.5mm<sup>2</sup>
- with mechanical interblock



TIPKALO ŽALUZIJSKO 10A 250V~ \_\_NT 09



- SQ53PWNT09XO
- SQ53TINT09XO
- SQ53ATNT09XO
- SQ53BKNT09XO

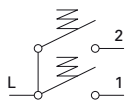

- NT 09 nevtral gor-dol
- 10A 250V~, tip SQ53
- ustreza EN 60669-1
- brezvijačna pritrditev vodnikov 1.5-2.5mm<sup>2</sup>
- z mehansko blokado hkratnega vklopa



PUSH BUTTON SHUTTERS 10A 250V~ \_\_ NT 09

- NT 09 neutral up-down
- 10A 250V~, type SQ53
- in accordance with EN 60669-1
- plug-in contacts 1.5-2.5mm<sup>2</sup>
- with mechanical interblock

STIKALO MENJALNO 10AX 250V~



- SQ60PWXO
- SQ60TIXO
- SQ60ATXO
- SQ60BKXO

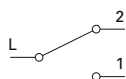

- 10AX 250V~, tip SQ60
- ustreza EN 60669-1
- brezvijačna pritrditev vodnikov 1.5-2.5mm<sup>2</sup>

SWITCH 2WAY 10AX 250V~

- 10AX 250V~, type SQ60
- in accordance with EN 60669-1
- plug-in contacts 1.5-2.5mm<sup>2</sup>



STIKALO MENJALNO 10AX 250V~\_IN



- SQ60PWINXO
- SQ60TIINXO
- SQ60ATINXO
- SQ60BKINXO

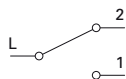

- IN indikator, brez tlivke
- 10AX 250V~, tip SQ60
- ustreza EN 60669-1
- brezvijačna pritrditev vodnikov 1.5-2.5mm<sup>2</sup>

SWITCH 2WAY 10AX 250V~\_IN

- IN indicator, without neon lamp
- 10AX 250V~, type SQ60
- in accordance with EN 60669-1
- plug-in contacts 1.5-2.5mm<sup>2</sup>



STIKALO MENJALNO 10AX 250V~\_IN 02



- SQ60PWIN02XO
- SQ60TIIN02XO
- SQ60ATIN02XO
- SQ60BKIN02XO

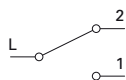

- IN 02 indikator luč, brez tlivke
- 10AX 250V~, tip SQ60
- ustreza EN 60669-1
- brezvijačna pritrditev vodnikov 1.5-2.5mm<sup>2</sup>

SWITCH 2WAY 10AX 250V~\_IN 02

- IN 02 indicator light, without neon lamp
- 10AX 250V~, type SQ60
- in accordance with EN 60669-1
- plug-in contacts 1.5-2.5mm<sup>2</sup>



NEW

NEW

STIKALO DVOJNO MENJALNO 10AX 250V~



- SQ63PWXO
- SQ63TIXO
- SQ63ATXO
- SQ63BKXO

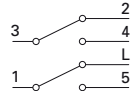

- 10AX 250V~, tip SQ63
- ustreza EN 60669-1
- brezvijačna pritrditev vodnikov 1.5-2.5mm<sup>2</sup>

*SWITCH DOUBLE 2WAY 10AX 250V~*  
 - 10AX 250V~, type SQ63  
 - in accordance with EN 60669-1  
 - plug-in contacts 1.5-2.5mm<sup>2</sup>



STIKALO KRIŽNO 10AX 250V~



- SQ70PWXO
- SQ70TIXO
- SQ70ATXO
- SQ70BKXO

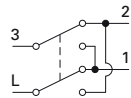

- 10AX 250V~, tip SQ70
- ustreza EN 60669-1
- brezvijačna pritrditev vodnikov 1.5-2.5mm<sup>2</sup>

*SWITCH INTERMEDIATE 10AX 250V~*  
 - 10AX 250V~, type SQ70  
 - in accordance with EN 60669-1  
 - plug-in contacts 1.5-2.5mm<sup>2</sup>



SQ10  
SQ11

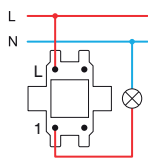

SQ22

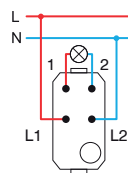

SQ50  
SQ51

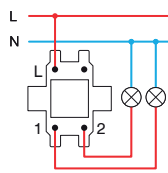

SQ52  
SQ53

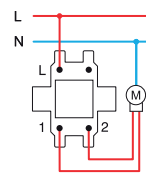

SQ60+SQ60

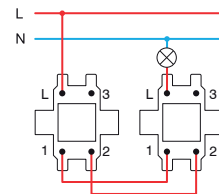

SQ63+SQ63

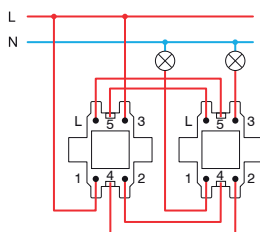

SQ60+SQ70+SQ60

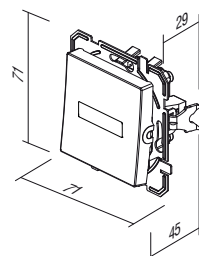
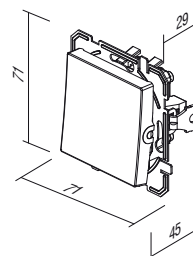
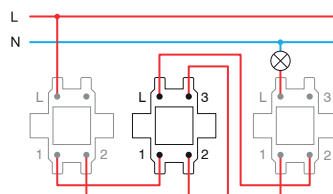

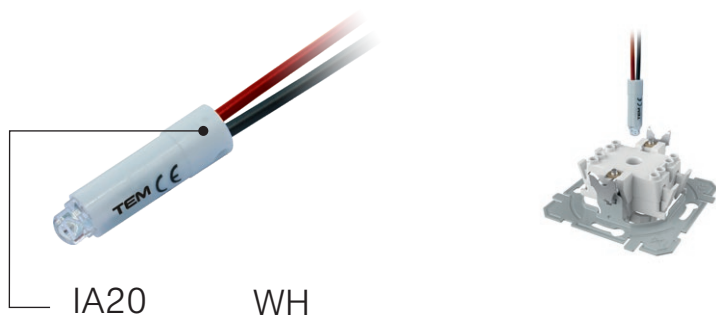

tip type	naziv description	tehnični opis technical data	barva colour
IA10	TLIVKA NEON LAMP	230V~ 0,34W	<input type="checkbox"/> WH bela white
IA20	LED SIGNALIZACIJA LED SIGNALLING UNIT	230V~ 0,40W	<input checked="" type="checkbox"/> BL modra blue
IA21	LED SIGNALIZACIJA LED SIGNALLING UNIT	24V AC/DC 0,20W	<input checked="" type="checkbox"/> RD rdeča red
⋮	⋮	⋮	<input checked="" type="checkbox"/> GR zelena green
⋮	⋮	⋮	<input checked="" type="checkbox"/> OR oranžna orange

**TLIVKA 230V~ 0,34W**

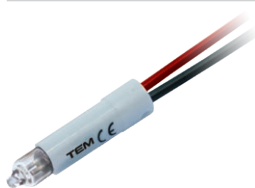

IA10OR

- za indikacijo, signalizacijo ali stalno signalizacijo stikala
- v kombinaciji s tipko z indikatorjem

*NEON LAMP 230V~ 0,34W*

- for indication, signalling or permanent signalling
- in combination with a button featuring an indicator

**LED SIGNALIZACIJA 230V AC/DC 0,40W**

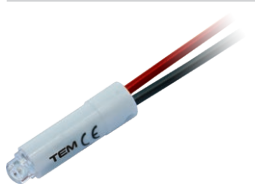

IA20WH  
 IA20GR  
 IA20RD  
 IA20BL

- za indikacijo, signalizacijo ali stalno signalizacijo stikala
- v kombinaciji s tipko z indikatorjem

*LED SIGNALLING UNIT 230V AC/DC 0,40W*

- for indication, signalling or permanent signalling
- in combination with a button featuring an indicator

**LED SIGNALIZACIJA 24V AC/DC 0,20W**



IA21WH  
 IA21RD

- za indikacijo, signalizacijo ali stalno signalizacijo stikala
- v kombinaciji s tipko z indikatorjem

*LED SIGNALLING UNIT 24V AC/DC 0,20W*

- for indication, signalling or permanent signalling
- in combination with a button featuring an indicator

**LED SIGNALIZACIJA 12V AC/DC 0,10W**

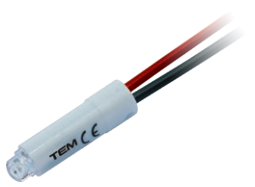

IA22WH  
 IA22RD

- za indikacijo, signalizacijo ali stalno signalizacijo stikala
- v kombinaciji s tipko z indikatorjem

*LED SIGNALLING UNIT 12V AC/DC 0,10W*

- for indication, signalling or permanent signalling
- in combination with a button featuring an indicator

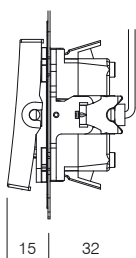

## S I G N A L I Z A T I O N I A

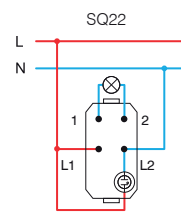
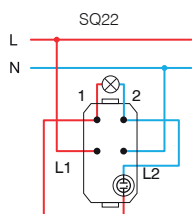
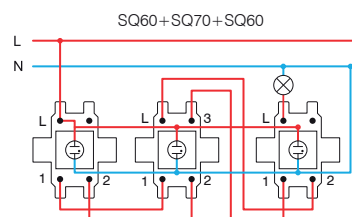
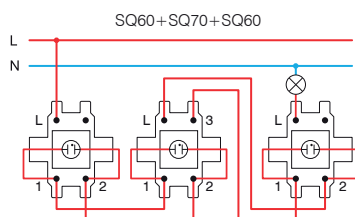
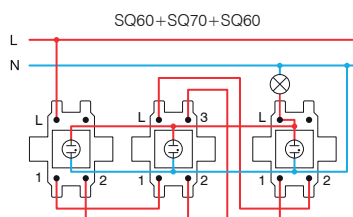
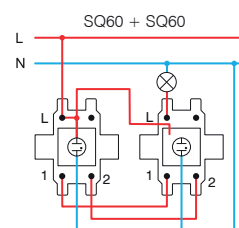
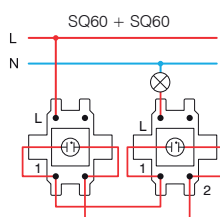
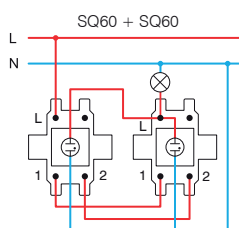
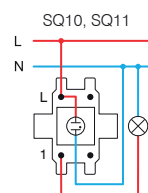
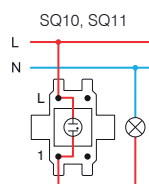
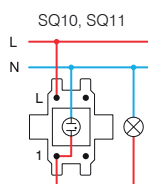
Indikacija /  
Indication\*Signalizacija /  
SignalizationStalna signalizacija /  
Permanent signalling

\* vezave niso primerne za varčne (CFL, LED) sijalke /  
the connections are not suitable for energy-saving bulbs (CFL, LED)

VQ10

PW

XO

tip type	naziv description	tehnični opis technical data	opcijski opis 1 optional data 1
VQ10	VTIČNICA SCHUKO SOCKET SCHUKO	2P+E 16A 250V~	XO brez okvirja without cover plate
VQ11	VTIČNICA SCHUKO+POKROV SOCKET SCHUKO+COVER	2P+E 16A 250V~	
VQ12	VTIČNICA SCHUKO SOCKET SCHUKO	2P+E 16A 250V~ BV	
⋮	⋮	⋮	
⋮	⋮	⋮	

barva  
colour

<input type="checkbox"/> PW	bela - sijaj polar white	<input checked="" type="checkbox"/> PT	bela+prozorna white+transparent	<input type="checkbox"/> PP	bela+bela white+white
<input type="checkbox"/> TI	titan titanium	<input checked="" type="checkbox"/> TT	titan+prozorna titanium+transparent	<input type="checkbox"/> TI	titan+titan titanium+titanium
<input checked="" type="checkbox"/> AT	antracit anthracite	<input checked="" type="checkbox"/> AT	antracit+prozorna anthracite+transparent	<input checked="" type="checkbox"/> AA	antracit+antracit anthracite+anthracite
<input checked="" type="checkbox"/> BK	črna black	<input checked="" type="checkbox"/> BT	črna+prozorna black+transparent	<input checked="" type="checkbox"/> BB	črna+črna black+black
<input checked="" type="checkbox"/> RD	rdeča red	<input checked="" type="checkbox"/> RT	rdeča+prozorna red+transparent	<input checked="" type="checkbox"/> RR	rdeča+rdeča red+red
<input checked="" type="checkbox"/> GR	zelena green	<input checked="" type="checkbox"/> GT	zelena+prozorna green+transparent	<input checked="" type="checkbox"/> GG	zelena+zelena green+green
<input checked="" type="checkbox"/> OR	oranžna orange	<input checked="" type="checkbox"/> OT	oranžna+prozorna orange+transparent	<input checked="" type="checkbox"/> OO	oranžna+oranžna orange+orange



schuko - ustreza EN 60884-1, CEE7 (list III)

schuko - in accordance with EN 60884-1, CEE7 (standard sheet III)

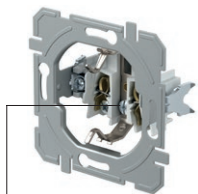

vijačna pritrditev vodnikov  
screw contacts

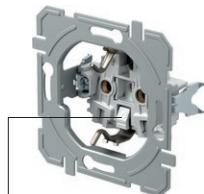

BV brezvijačna pritrditev vodnikov  
BV plug-in contacts

## S O C K E T S V Q

## VTIČNICA SCHUKO 2P+E 16A 250V~ \_\_ XO

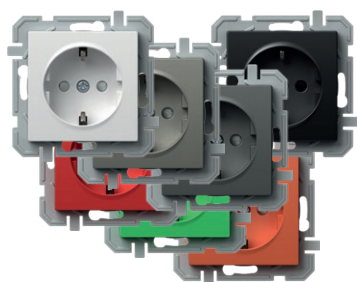

- VQ10PWXO
- VQ10TIXO
- VQ10ATXO
- VQ10BKXO
- VQ10RDXO
- VQ10GRXO
- VQ10ORXO

- vijajna pritrditev vodnikov 1.5-2.5mm<sup>2</sup>
- XO brez okvirja
- 2P+E schuko
- 16A 250V~, tip VQ10
- vgrajena zaščita pred dotikom kontaktov



## SOCKET SCHUKO 2P+E 16A 250V~ \_\_ XO

- screw contacts 1.5-2.5mm<sup>2</sup>
- XO without surround
- 2P+E schuko
- 16A 250V~, type VQ10
- shuttered live contacts

## VTIČNICA SCHUKO+POKROV 2P+E 16A 250V~ \_\_ XO

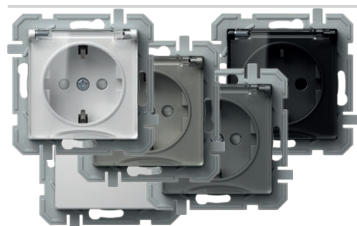

- VQ11PTXO
- VQ11TTXO
- VQ11ATXO
- VQ11BTXO
- VQ11PPXO

- vijajna pritrditev vodnikov 1.5-2.5mm<sup>2</sup>
- XO brez okvirja
- 2P+E schuko+pokrov
- 16A 250V~, tip VQ11
- vgrajena zaščita pred dotikom kontaktov



## SOCKET SCHUKO+COVER 2P+E 16A 250V~ \_\_ XO

- screw contacts 1.5-2.5mm<sup>2</sup>
- XO without surround
- 2P+E schuko+cover
- 16A 250V~, type VQ11
- shuttered live contacts

## VTIČNICA SCHUKO 2P+E 16A 250V~ BV \_\_ XO

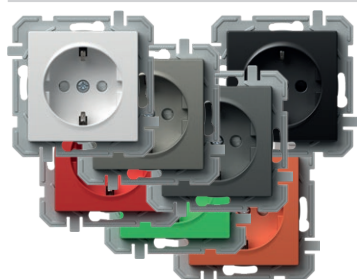

- VQ12PWXO
- VQ12TIXO
- VQ12ATXO
- VQ12BKXO
- VQ12RDXO
- VQ12GRXO
- VQ12ORXO

- BV brezvijajna pritrditev vodnikov 1.5-2.5mm<sup>2</sup>
- XO brez okvirja
- 2P+E schuko
- 16A 250V~, tip VQ12
- vgrajena zaščita pred dotikom kontaktov



## SOCKET SCHUKO 2P+E 16A 250V~ BV \_\_ XO

- BV plug-in contacts 1.5-2.5mm<sup>2</sup>
- XO without surround
- 2P+E schuko
- 16A 250V~, type VQ12
- shuttered live contacts

## VTIČNICA SCHUKO+POKROV 2P+E 16A 250V~ BV \_\_ XO



- VQ13PTXO
- VQ13TTXO
- VQ13ATXO
- VQ13BTXO
- VQ13PPXO

- BV brezvijajna pritrditev vodnikov 1.5-2.5mm<sup>2</sup>
- XO brez okvirja
- 2P+E schuko+pokrov
- 16A 250V~, tip VQ13
- vgrajena zaščita pred dotikom kontaktov



## SOCKET SCHUKO+COVER 2P+E 16A 250V~ BV \_\_ XO

- BV plug-in contacts 1.5-2.5mm<sup>2</sup>
- XO without surround
- 2P+E schuko+cover
- 16A 250V~, type VQ13
- shuttered live contacts

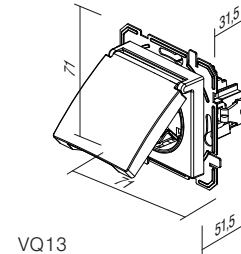
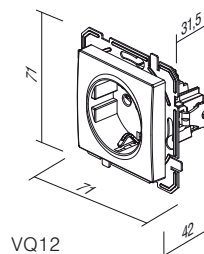
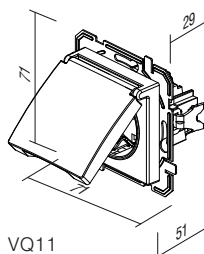
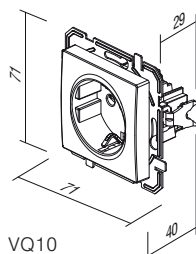

VTIČNICA FRANCOŠKA 2P+E 16A 250V~ \_\_ XO

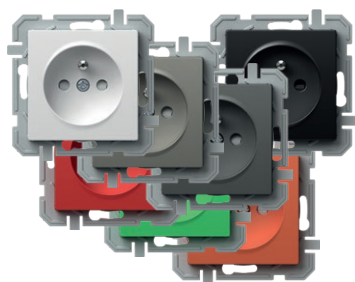

- VQ40PWXO
- VQ40TIXO
- VQ40ATXO
- VQ40BKXO
- VQ40RDXO
- VQ40GRXO
- VQ40ORXO

- vijačna pritrditev vodnikov 1.5-2.5mm<sup>2</sup>
- XO brez okvirja
- 2P+E francoska
- 16A 250V~, tip VQ40
- vgrajena zaščita pred dotikom kontaktov



SOCKET FRENCH 2P+E 16A 250V~ \_\_ XO

- screw contacts 1.5-2.5mm<sup>2</sup>
- XO without surround
- 2P+E French
- 16A 250V~, type VQ40
- shuttered live contacts

VTIČNICA FRANCOŠKA+POKROV 2P+E 16A 250V~ \_\_ XO



- ▣ VQ41PTXO
- ▣ VQ41TTXO
- ▣ VQ41ATXO
- ▣ VQ41BTXO
- VQ41PPXO

- vijačna pritrditev vodnikov 1.5-2.5mm<sup>2</sup>
- XO brez okvirja
- 2P+E francoska+pokrov
- 16A 250V~, tip VQ41
- vgrajena zaščita pred dotikom kontaktov



SOCKET FRENCH+COVER 2P+E 16A 250V~ \_\_ XO

- screw contacts 1.5-2.5mm<sup>2</sup>
- XO without surround
- 2P+E French+cover
- 16A 250V~, type VQ41
- shuttered live contacts

VTIČNICA SCHUKO DVOJNA 2P+E 16A 250V~



- VQ16PWF
- VQ16TIF
- VQ16ATF
- VQ16BKF

- 2P+E schuko dvojna
- 16A 250V~, tip VQ16
- ustreza IEC 60884-1, CEE7
- vijačna pritrditev vodnikov 1.5-2.5 mm<sup>2</sup>
- vgrajena zaščita pred dotikom kontaktov



SOCKET SCHUKO DOUBLE 2P+E 16A 250V~

- 2P+E schuko double
- 16A 250V~, type VQ16
- in accordance with IEC 60884-1, CEE7
- screw contacts 1.5-2.5 mm<sup>2</sup>
- shuttered live contacts

VTIČNICA SCHUKO DVOJNA 2P+E 16A 250V~



- VQ16PW
- VQ16TI
- VQ16AT
- VQ16BK

- 2P+E schuko dvojna
- 16A 250V~, tip VQ16
- ustreza IEC 60884-1, CEE7
- vijačna pritrditev vodnikov 1.5-2.5 mm<sup>2</sup>
- vgrajena zaščita pred dotikom kontaktov



SOCKET SCHUKO DOUBLE 2P+E 16A 250V~

- 2P+E schuko double
- 16A 250V~, type VQ16
- in accordance with IEC 60884-1, CEE7
- screw contacts 1.5-2.5 mm<sup>2</sup>
- shuttered live contacts

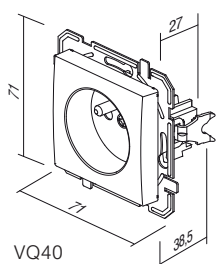

VQ40

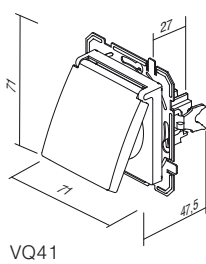

VQ41

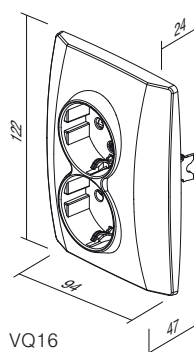

VQ16

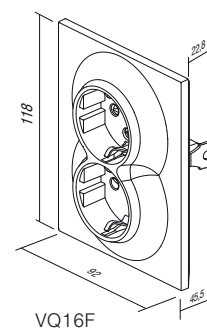

VQ16F



## S O C K E T S V Q

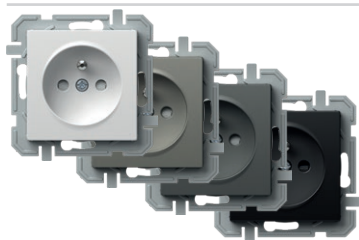

- VQ42PWXO
- VQ42TIXO
- VQ42ATXO
- VQ42BKXO

## VTIČNICA FRANCOŠKA 2P+E 16A 250V~ BV \_\_ XO

- BV brezvijačna pritrnitev vodnikov 1.5-2.5mm<sup>2</sup>
- XO brez okvirja
- 2P+E francoska
- 16A 250V~, tip VQ42
- vgrajena zaščita pred dotikom kontaktov



## SOCKET FRENCH 2P+E 16A 250V~ BV \_\_ XO

- BV plug-in contacts 1.5-2.5mm<sup>2</sup>
- XO without surround
- 2P+E French
- 16A 250V~, type VQ42
- shuttered live contacts



- VQ43PTXO
- VQ43TTXO
- VQ43ATXO
- VQ43BTXO
  
- VQ43PPXO

## VTIČNICA FRANCOŠKA+POKROV 2P+E 16A 250V~ BV \_\_ XO

- BV brezvijačna pritrnitev vodnikov 1.5-2.5mm<sup>2</sup>
- XO brez okvirja
- 2P+E francoska+pokrov
- 16A 250V~, tip VQ43
- vgrajena zaščita pred dotikom kontaktov



## SOCKET FRENCH+COVER 2P+E 16A 250V~ BV \_\_ XO

- BV plug-in contacts 1.5-2.5mm<sup>2</sup>
- XO without surround
- 2P+E French+cover
- 16A 250V~, type VQ43
- shuttered live contacts



- VQ46PWF
- VQ46TIF
- VQ46ATF
- VQ46BKF

## VTIČNICA FRANCOŠKA DVOJNA 2P+E 16A 250V~

- 2P+E francoska dvojna
- 16A 250V~, tip VQ46
- ustreza IEC 60884-1, CEE7; NF C 61-314, ČSN 33 2318; PN-E 93201
- vijajna pritrnitev vodnikov 1,5-2,5 mm<sup>2</sup>
- vgrajena zaščita pred dotikom kontaktov



## SOCKET FRENCH DOUBLE 2P+E 16A 250V~

- 2P+E French double
- 16A 250V~, type VQ46
- in accordance with IEC 60884-1, CEE7; NF C 61-314, ČSN 33 2318; PN-E 93201
- screw contacts 1,5-2,5 mm<sup>2</sup>
- shuttered live contacts



- VQ46PW
- VQ46TI
- VQ46AT
- VQ46BK

## VTIČNICA FRANCOŠKA DVOJNA 2P+E 16A 250V~

- 2P+E francoska dvojna
- 16A 250V~, tip VQ46
- ustreza IEC 60884-1, CEE7; NF C 61-314, ČSN 33 2318; PN-E 93201
- vijajna pritrnitev vodnikov 1,5-2,5 mm<sup>2</sup>
- vgrajena zaščita pred dotikom kontaktov



## SOCKET FRENCH DOUBLE 2P+E 16A 250V~

- 2P+E French double
- 16A 250V~, type VQ46
- in accordance with IEC 60884-1, CEE7; NF C 61-314, ČSN 33 2318; PN-E 93201
- screw contacts 1,5-2,5 mm<sup>2</sup>
- shuttered live contacts

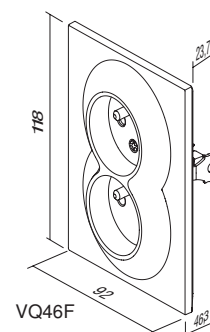
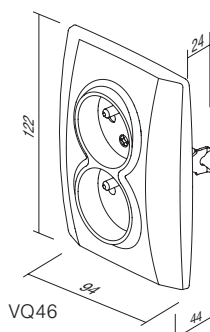
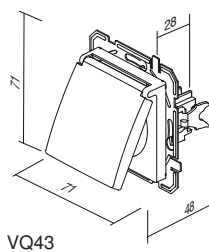
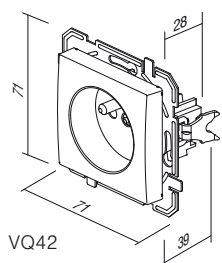

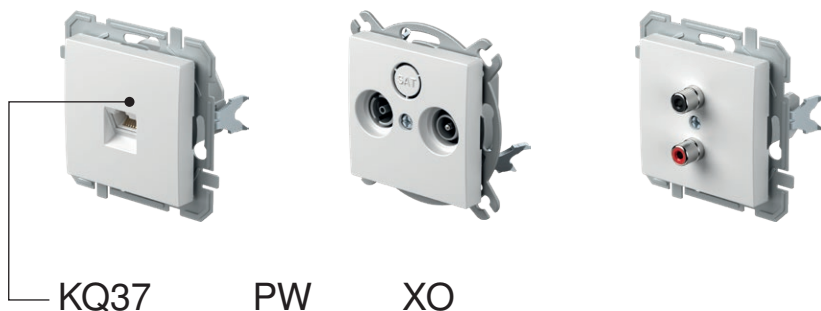

tip type	naziv description	tehnični opis technical data	barva colour	opsijski opis 1 optional data 1
KQ11	VTIČNICA TV-R KONČNA SOCKET TV-R END-LINE	1dB	<input type="checkbox"/> PW bela - sijaj polar white	XO brez okvirja without cover plate
KQ12	VTIČNICA TV-R PREHODNA SOCKET TV-R THROUGHPASS	10dB	<input type="checkbox"/> TI titan titanium	
KQ16	VTIČNICA SAT-TV-R KONČNA SOCKET SAT-TV-R END-LINE	3dB	<input type="checkbox"/> AT antracit anthracite	
⋮	⋮	⋮	<input type="checkbox"/> BK črna black	

VTIČNICA TV OSNOVNA 0dB



- KQ10PWXO
- KQ10TIXO
- KQ10ATXO
- KQ10BKXO

- TV osnovna
- dušenje 0dB
- konektor zadaj – F standard

SOCKET TV BASIC 0dB

- TV basic
- reduction 0dB
- back connector – F standard



VTIČNICA TV-R KONČNA 1dB

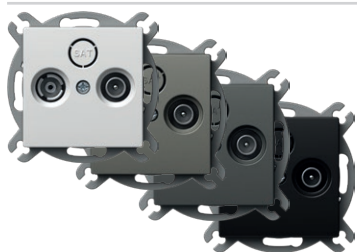

- KQ11PWXO
- KQ11TIXO
- KQ11ATXO
- KQ11BKXO

- TV-R končna
- frekvenčni pas 5÷862 MHz
- dušenje: R-1.5dB, TV-1dB
- ustreza EN 50083-1
- vijačna priključitev

SOCKET TV-R END-LINE 1dB

- TV-R end-line
- frequency range 5÷862 MHz
- reduction: R-1.5dB, TV-1dB
- in accordance with EN 50083-1
- screw contact



## VTIČNICA TV-R PREHODNA 10dB

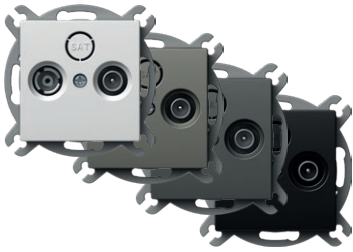

- KQ12PWXO
- KQ12TIXO
- KQ12ATXO
- KQ12BKXO

- TV-R prehodna
- frekvenčni pas 5÷862 MHz
- dušenje: R-10dB, TV-10dB, prehod-2dB
- ustreza EN 50083-1
- vijačna priključitev

## SOCKET TV-R TROUGH-PASS 10dB

- TV-R troughpass
- frequency range 5÷862 MHz
- reduction: R-10dB, TV-10dB, trough-2dB
- in accordance with EN 50083-1
- screw contacts



## VTIČNICA SAT-TV-R KONČNA 3dB

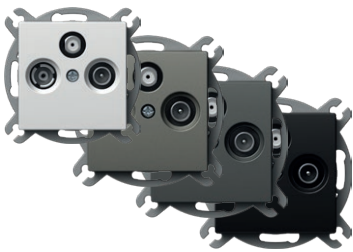

- KQ16PWXO
- KQ16TIXO
- KQ16ATXO
- KQ16BKXO

- SAT-TV-R končna
- frekvenčni pas 5÷2400 MHz
- dušenje: R-1dB, TV-1.5dB, SAT-3dB
- ustreza EN 50083-1
- vijačna priključitev

## SOCKET SAT-TV-R END-LINE 3dB

- SAT-TV-R end-line
- frequency range 5÷2400 MHz
- reduction: R-1dB, TV-1.5dB, SAT-3dB
- in accordance with EN 50083-1
- screw contacts



## VTIČNICA AVDIO 2xRCA



- KQ22PWXO
- KQ22TIXO
- KQ22ATXO
- KQ22BKXO

- avdio 2xRCA
- pritrditev vodnikov s spajkanjem

## SOCKET AUDIO 2xRCA

- audio 2xRCA
- soldering connection of cable



## VTIČNICA AVDIO ZVOČNIŠKA



- KQ23PWXO
- KQ23TIXO
- KQ23ATXO
- KQ23BKXO

- avdio 2x Ø4mm
- za priklop zvočniškega vodnika, vtiča Ø4mm ali viličastega kabel čevlja
- pritrditev vodnikov zadaj s spajkanjem

*SOCKET AUDIO LOUDSPEAKERS*

- audio 2x Ø4mm
- to accommodate speaker wire, banana plug Ø4mm or spades
- soldering connection of cable at the back side



## VTIČNICA TEL KS RJ11 6/4



- KQ36PWXO
- KQ36TIXO
- KQ36ATXO
- KQ36BKXO

- KS keystone pritrditveni standard
- RJ11 6/4
- ustreza IEC 60603-7

*SOCKET TEL KS RJ11 6/4*

- KS keystone fixing standard
- RJ11 6/4
- in accordance with IEC 60603-7



## VTIČNICA CAT5e KS RJ45 8/8



- KQ37PWXO
- KQ37TIXO
- KQ37ATXO
- KQ37BKXO

- KS keystone pritrditveni standard
- CAT5e, RJ45 8/8
- ustreza IEC 60603-7

*SOCKET CAT5e KS RJ45 8/8*

- KS keystone fixing standard
- CAT5e, RJ45 8/8
- in accordance with IEC 60603-7



## VTIČNICA TEL KS DVOJNA 2x RJ11 6/4

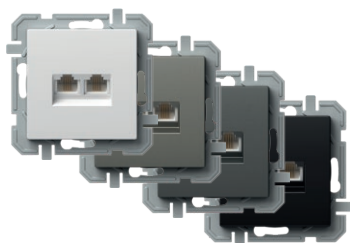

- KQ38PWXO
- KQ38TIXO
- KQ38ATXO
- KQ38BKXO

- KS keystone pritrditveni standard
- 2x RJ11, 6/4
- ustreza IEC 60603-7

*SOCKET TEL KS DOUBLE 2x RJ11 6/4*

- KS keystone fixing standard
- 2x RJ11, 6/4
- in accordance with IEC 60603-7



## VTIČNICA CAT5e KS DVOJNA 2x RJ45 8/8



- KQ39PWXO
- KQ39TIXO
- KQ39ATXO
- KQ39BKXO

- KS keystone pritrditveni standard  
- 2x CAT5e, RJ45 8/8  
- ustreza IEC 60603-7

## SOCKET CAT5e KS DOUBLE 2x RJ45 8/8

- KS keystone fixing standard  
- 2x CAT5e, RJ45 8/8  
- in accordance with IEC 60603-7



## VTIČNICA TEL LT RJ11 6/4



- KQ35PWXO
- KQ35TIXO
- KQ35ATXO
- KQ35BKXO

- TEL LT vijak  
- vijačna pritrditev vodnikov  
- RJ11 6/4  
- ustreza IEC 60603-7

## SOCKET TEL LT RJ11 6/4

- TEL LT screw  
- screw contacts  
- RJ11 6/4  
- in accordance with IEC 60603-7



## VTIČNICA CAT6s KS RJ45 8/8 SLIM

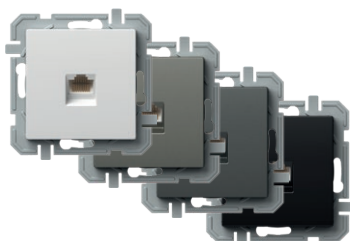

- KQ40PWXO
- KQ40TIXO
- KQ40ATXO
- KQ40BKXO

- KS keystone pritrditveni standard  
- CAT6s, RJ45 8/8  
- ustreza IEC 60603-7

## SOCKET CAT6s KS RJ45 8/8 SLIM

- KS keystone fixing standard  
- CAT6s, RJ45 8/8  
- in accordance with IEC 60603-7



## VTIČNICA CAT6s KS DVOJNA 2x RJ45 8/8 SLIM



- KQ41PWXO
- KQ41TIXO
- KQ41ATXO
- KQ41BKXO

- KS keystone pritrditveni standard  
- 2x CAT6, RJ45 8/8  
- ustreza IEC 60603-7

## SOCKET CAT6s KS DOUBLE 2x RJ45 8/8 SLIM

- KS keystone fixing standard  
- 2x CAT6s, RJ45 8/8  
- in accordance with IEC 60603-7

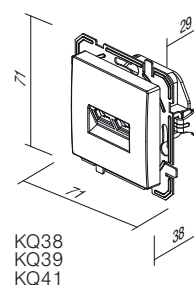
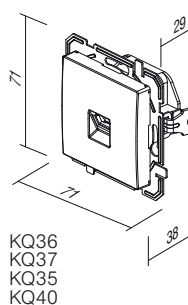
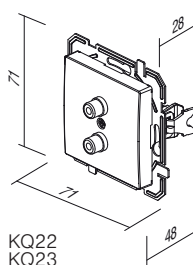
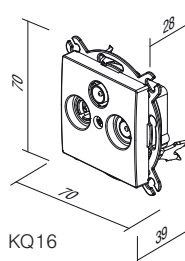
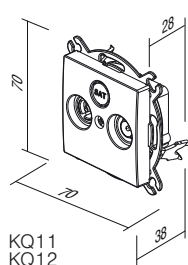
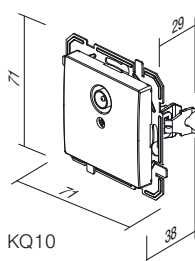



EQ15

PW

XO

tip type	naziv description	tehnični opis technical data	barva colour	opsijski opis 1 optional data 1
EQ15	ZATEMNILNIK ROTACIJSKI MEN DIMMER ROTATIVE 2WAY	RL 400W	<input type="checkbox"/> PW bela - sijaj polar white	XO brez okvirja without cover plate
EQ16	ZATEMNILNIK ROTACIJSKI MEN DIMMER ROTATIVE 2WAY	RLC 400W	<input type="checkbox"/> TI titan titanium	
EQ19	ZATEMNILNIK ROTACIJSKI MEN DIMMER ROTATIVE 2WAY	LED 100W	<input type="checkbox"/> AT antracit anthracite <input type="checkbox"/> BK črna black	
·	·	·		

#### ZATEMNILNIK ROTACIJSKI MEN RL 400W



- EQ15PWXO
- EQ15TIXO
- EQ15ATXO
- EQ15BKXO



#### DIMMER ROTATIVE 2WAY RL 400W

- rotacijski z menjalnim stikala
- breme RL, 40W - 400W
- možna vezava z menjalnim stikalom
- vezava več zatemnilnikov ni dovoljena
- ustreza EN 60669-1 in EN 60669-2-1
- brezvijačna pritrditev vodnikov 1.5mm<sup>2</sup>
- napajanje 230V~ 50Hz
- zamenljiva varovalka vključena



#### ZATEMNILNIK ROTACIJSKI MEN RLC 400W

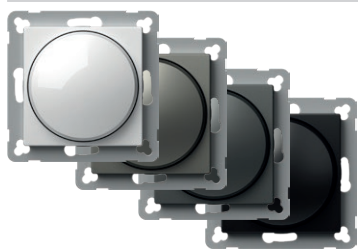

- EQ16PWXO
- EQ16TIXO
- EQ16ATXO
- EQ16BKXO



#### DIMMER ROTATIVE 2WAY RLC 400W

- rotacijski z menjalnim stikalom
- breme RLC, 20W - 400W
- možna vezava z menjalnim stikalom
- vezava več zatemnilnikov ni dovoljena
- ustreza EN 60669-1 in EN 60669-2-1
- brezvijačna pritrditev vodnikov 1.5mm<sup>2</sup>
- napajanje 230V~ 50Hz
- elektronska varovalka



#### ZATEMNILNIK ROTACIJSKI MEN LED 100W

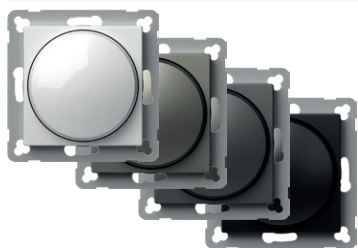

- EQ19PWXO
- EQ19TIXO
- EQ19ATXO
- EQ19BKXO



#### DIMMER ROTATIVE 2WAY LED 100W

- rotacijski z menjalnim stikalom
- breme: LED, 0-100W (max. 10 LED sijalk)
- GLS, 10-250W
- možna vezava z menjalnim stikalom
- vezava več zatemnilnikov ni dovoljena
- ustreza EN 60669-1 in EN 60669-2-1
- brezvijačna pritrditev vodnikov 1,5 mm<sup>2</sup>
- napajanje 230V~ 50 Hz
- zamenljiva varovalka vključena



EQ15, EQ16, EQ19

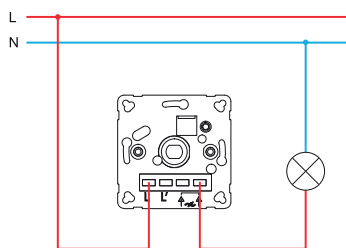

EQ15, EQ16, EQ19

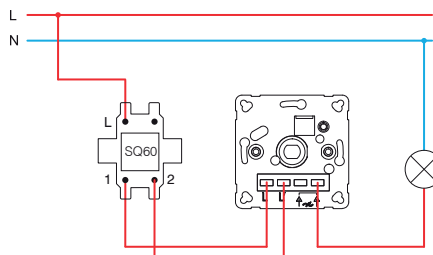

EQ15, EQ16, EQ19

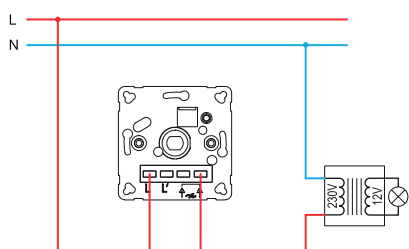

EQ15, EQ16, EQ19

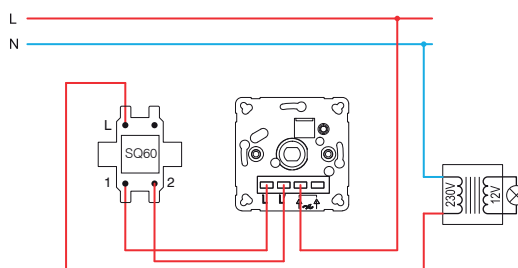

EQ16, EQ19

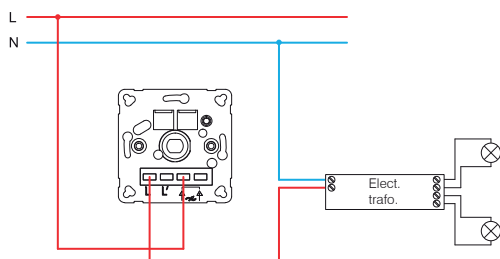

EQ16, EQ19

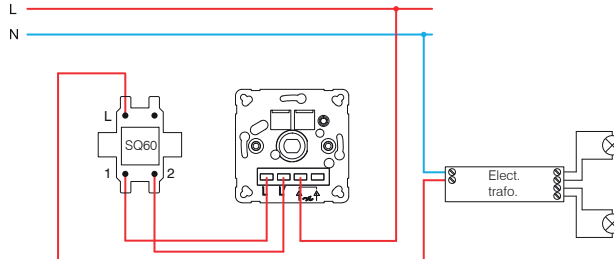
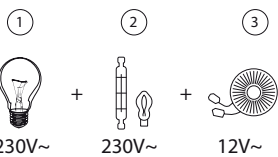
**EQ15 (40÷400W)**

- 1 - žarnica z žarilno nitko /  
incandescent lamp  
2 - halogenska žarnica /  
halogen lamp

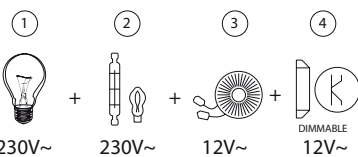
**EQ16 (20÷400W)**

- 3 - klasični transformator /  
classical transformer  
4 - zatemnilni el. transformator /  
dimmable electronic transformer

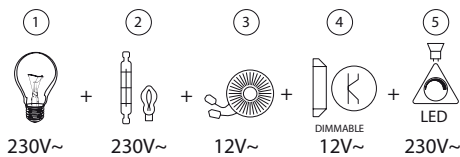
**EQ19 (GLS 10÷250W ; LED 0÷100W)**

- 5 - zatemnilna LED sijalka /  
dimmable LED lamp

KRMILNI modul MZC za EM18

EM17

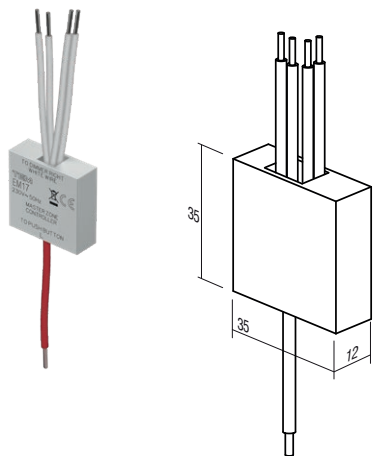

- MZC priklopite po vezalni shemi.
- možna vezava z več tipkali
- montaža samo ene naprave v eno dozo
- samo za notranjo uporabo
- napajanje: 230 V~ 50Hz
- maksimalna upornost žic: 50 kΩ
- maksimalen tok na enoto MZC: 10 mA
- število zatemnilnikov na MZC: 1-4
- maksimalno število MZC v vezavi: omejeno na varovalko v tokokrogu
- temperatura delovanja: -5 °C do 45 °C
- temperatura skladiščenja: -30 °C do 80 °C
- maksimalna vlažnost: 90 % (brez kondenziranja)
- dimenzije ohišja: 36 x 36 x 12 mm

MZC CONTROL Module for EM18

- Connect the MZC according to the wiring diagram.
- Possible wiring with several push buttons.
- Only one device installation per mounting box.
- For indoor use only.
- Power supply: 230V~ 50Hz
- Max. cable resistance: 50kΩ
- Max. current per MZC unit: 10mA
- Number of dimmers on MZC: 1-4
- Max. number of MZC in the wiring: limited to the fuse in the circuit
- Operating temperature: -5°C to 45°C
- Storage temperature: -30°C to 80°C
- Max. humidity: 90% (no condensation)
- Casing dimensions: 36x36x12 mm

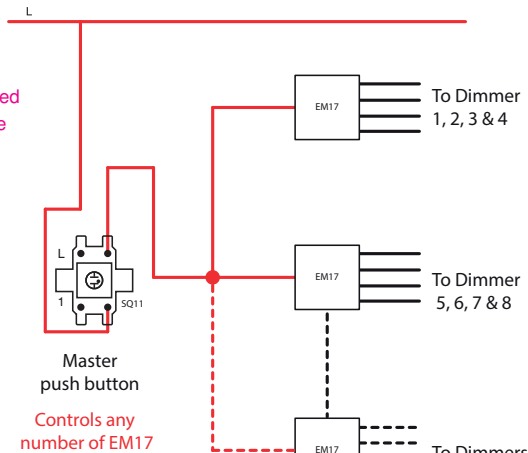
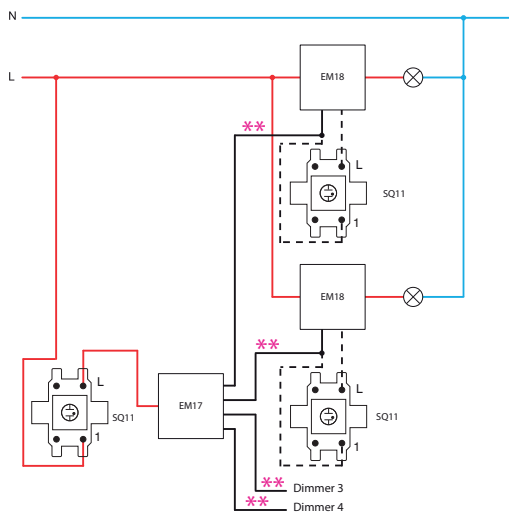

ZATEMNILNIK VGRADNI LED 250W

EM18

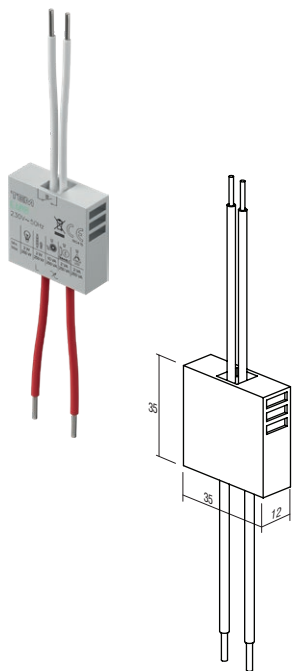

- vgradni, za vezavo s tipkalom
- za leading ali trailing edge
- napajanje 230 V~ 50 Hz
- možna vezava z več tipkali
- funkcija pomnjenja zadnje nastavitve, razen v primeru izpada napetosti
- funkcija mehkega vklopa/izklopa
- nastavev minimalne svetilnosti
- montaža samo ene naprave v eno dozo
- samo za notranjo uporabo
- ustreza EN 60669-1 in EN 60669-2-1



DIMMER INBOX LED 250W

- inbox, controlled by external push button
- for leading or trailing edge
- supply voltage 230V~ 50Hz
- several push-buttons combinations is possible
- memory function of the last setting, except in the case of a power failure
- soft start / stop function
- minimum intensity control
- only one dimmer per wall box
- only for indoor usage
- in accordance with EN 60669-1 and EN 60669-2-1

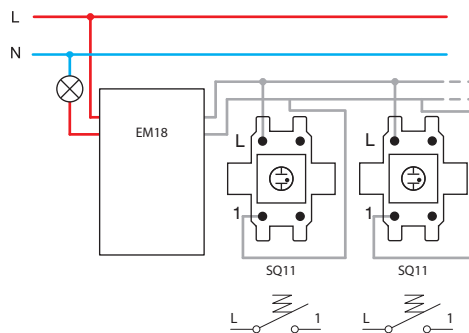



## ZATEMNILNIK VGRADNI DC LED 96W

EM19

- vgradni, za vezavo s tipkalom
- vezava z vsemi LED napajalniki s konstantno napetostjo in nekaterimi LED napajalniki s konstantnim tokom, 9 – 48V DC, max 96W (tudi za LED trakove)
- ni za uporabo z induktivnimi bremenji
- možna vezava z več tipkali in več zatemnilniki
- funkcija pomnjenja zadnje nastavitve, razen v primeru izpada napetosti
- funkcija mehkega vklopa / izklopa
- montaža samo ene naprave v eno dozo
- samo za notranjo uporabo

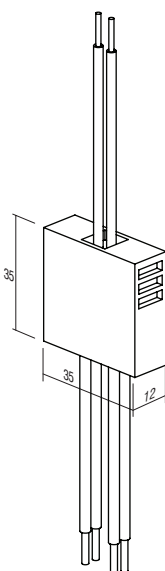

## DIMMER INBOX DC LED 96W

- inbox, controlled by external push button
- for use with constant voltage LED drivers and some constant current LED drivers, 9-48V DC, max 96W (also for LED strips)
- not for use with inductive loads
- several push-buttons combinations and several dimmers is possible
- memory function of the last setting, except in the case of a power failure
- soft start / stop function
- only one dimmer per wall box
- only for indoor usage

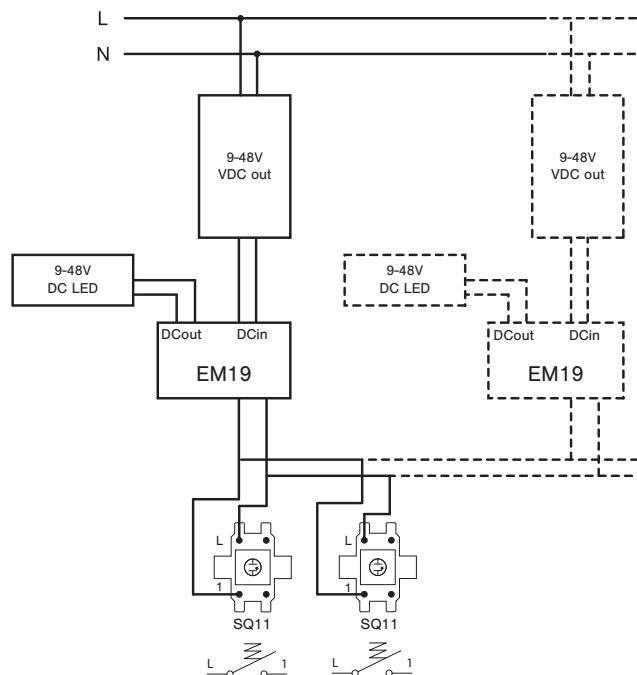
**POZORI!**

V primeru montaže več zatemnilnih stikal v isto dozo se za vsako dodatno zatemnilno stikalo zmanjša maksimalna skupna moč za 10%.

**ATTENTION!**

If more dimmers are connected in one box reduce maximum common power for 10% for each dimmer.

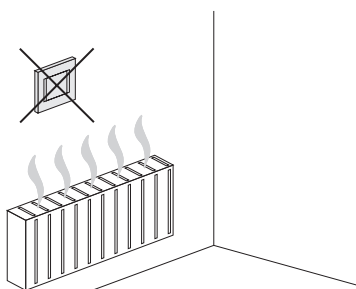

## EM18 (2÷250VA)

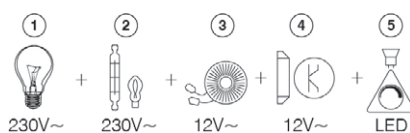

- 1 - žarnica z žarilno nitko / incandescent lamp
- 2 - halogenska žarnica / halogen lamp
- 3 - klasični transformator / classical transformer
- 4 - zatemnilni elektronski transformator / dimmable electronic transformer
- 5 - zatemnilna LED sijalka / dimmable LED lamp

### IR STIKALO 5A 230V~



- EQ32PWXO
- EQ32TIXO
- EQ32ATXO
- EQ32BKXO



- IR infrardeče stikalo
- napajanje: 230V~ ±10 % 50Hz
- rele: 5A / 250V~ zero crossing
- stopnja varnosti: IP40
- presek žic pri stičniku: 0,75 - 2,5 mm<sup>2</sup>
- kot zaznavanja: do 110° pri 20°C
- območje zaznavanja: približno 8 m pri 20°C
- nastavljivost časovnega trajanja: od približno 5 s do 12 min
- nastavljivost osvetlitve: od približno 5 do 200 LUX
- temperatura delovanja: od 0°C do +40°C
- ni primeren za vgradnjo v doze, globine 45 mm
- samo za notranjo uporabo

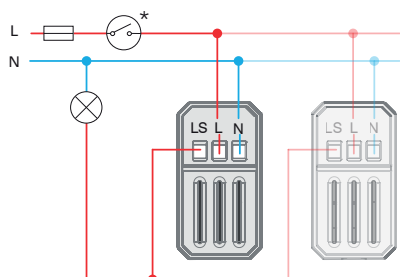

### IR SWITCH 5A 230V~

- IR infrared switch
- supply voltage: 230V~ ±10 % 50Hz
- relay: 5A / 250V~ output for limited current with high resistance for zero crossing
- protection rating: IP40
- cross-section of wires at the contact terminal: 0.75 - 2.5 mm<sup>2</sup>
- detection angle: up to 110° at 20°C
- detection area: approx. 8 m at 20°C
- adjustability of duration: from approx. 5 s to 12 min
- adjustability of brightness: from approx. 5 to 200 LUX
- operating temperature: from 0°C to +40°C
- not suitable for installation in 45 mm deep boxes
- only for indoor usage

### TERMOSTAT OGREVANJE 10A 230V~

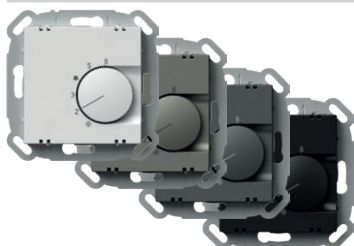

- EQ35PWXO
- EQ35TIXO
- EQ35ATXO
- EQ35BKXO

- način delovanja: ogrevanje
- napajanje: 230 V~, 50 Hz
- izhod: 4 A (max. 10 A), 230 V~, 50 Hz
- izhodni priključek: NO (max. 10 aktuatorjev)
- območje regulacije: +5 °C do +30 °C
- histereza: 0,5 K
- zaščita: IP30
- vrsta tipala: bimetal
- vrsta električnega priključka: vzmetni kontakti
- vrsta vodnikov: 0,75 - 1,5mm<sup>2</sup> (mehko-žilni) ali 1,0 - 2,5 mm<sup>2</sup> (trdo-žilni)

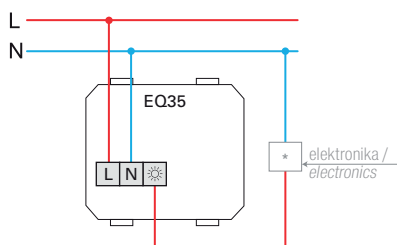

### THERMOSTAT HEATING 10A 230V~

- operation mode: heating
- power supply: 230 V~, 50 Hz
- output: 4 A (max. 10 A), 230 V~, 50 Hz
- switching contact: NC (max. 10 actuators)
- regulation range: +5 °C to +30 °C
- hysteresis: 0,5 K
- protection: IP30
- sensor type: bimetal
- type of electrical connection: spring-loaded contacts
- type of conductors: 0,75 - 1,5mm<sup>2</sup> (flexible-stranded core) or 1,0 - 2,5 mm<sup>2</sup> (solid core)

### TERMOSTAT OGREVANJE / HLAJENJE 5A 230V~

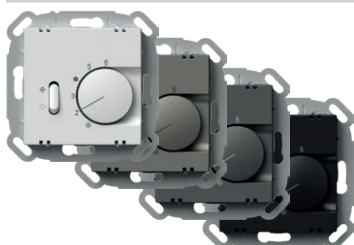

- EQ36PWXO
- EQ36TIXO
- EQ36ATXO
- EQ36BKXO

- način delovanja: ogrevanje / hlajenje
- napajanje: 230 V~, 50 Hz
- izhod: 2 A (max. 5 A), 230 V~, 50 Hz
- izhodni priključek: preklopno stikalo (max. 5 aktuatorjev)
- območje regulacije: +5 °C do +30 °C
- histereza: 0,5 K
- zaščita: IP30
- vrsta tipala: bimetal
- vrsta električnega priključka: vzmetni kontakti
- vrsta vodnikov: 0,75 - 1,5mm<sup>2</sup> (mehko-žilni) ali 1,0 - 2,5 mm<sup>2</sup> (trdo-žilni)

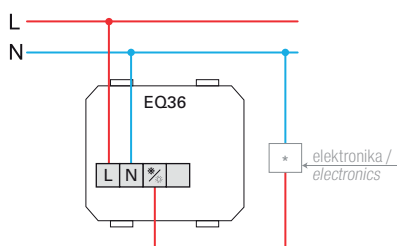

### THERMOSTAT HEATING / COOLING 5A 230V~

- operation mode: heating / cooling
- power supply: 230 V~, 50 Hz
- output: 2 A (max. 5 A), 230 V~, 50 Hz
- switching contact: changeover switch (toggler, max. 5 actuators)
- regulation range: +5 °C to +30 °C
- hysteresis: 0,5 K
- protection: IP30
- sensor type: bimetal
- type of electrical connection: spring-loaded contacts
- type of conductors: 0,75 - 1,5mm<sup>2</sup> (flexible-stranded core) or 1,0 - 2,5 mm<sup>2</sup> (solid core)

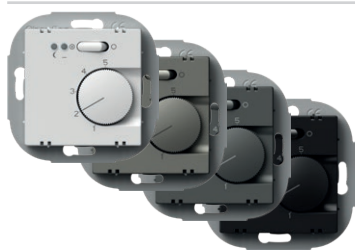

- EQ37PWXO
- EQ37TIXO
- EQ37ATXO
- EQ37BKXO

#### TERMOSTAT TALNO OGREVANJE 16A 230V~

- način delovanja: talno ogrevanje
- napajanje: 230 V~, 50 Hz
- izhod: 2 A (max. 16 A), 230 V~, 50 Hz
- območje regulacije: +10 °C do +50 °C
- histereza: 1 K
- zaščita: IP30
- vrsta tipala: NTC v skladu z DIN EN 60730-2-1
- indikatorji:
  - rdeča LED za ogrevanje in
  - zelena LED za nočni zmanjšani način
- vrsta električnega priključka: vijaki kontakti
- vrsta vodnikov: 0,5 – 2,5 mm<sup>2</sup>

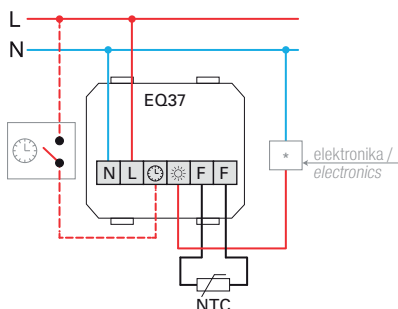

#### THERMOSTAT FLOOR HEATING 16A 230V~

- operation mode: floor heating
- power supply: 230 V~, 50 Hz
- output: 2 A (max. 16 A), 230 V~, 50 Hz
- regulation range: +10 °C to +50 °C
- hysteresis: 1 K
- protection: IP30
- sensor type: NTC in compliance with DIN EN 60730-2-1
- indicators: Red LED for heating and green LED for night decrease mode
- type of electrical connection: Screw contacts
- type of conductors: 0,5 – 2,5mm<sup>2</sup>



- EQ01PWXO

#### PODOMETNI RADIO + ZVOČNIK DAB BLUETOOTH

- napajanje: 230 V~ / 50 Hz
- poraba energije med običajnim delovanjem: max. 6 W
- poraba energije v stanju pripravljenosti: < 0.5 W
- razred zaščite: IP20
- frekvence sprejema: DAB/DAB+ 174,928–239,200 MHz FM: 87,5–108 MHz
- bluetooth: Različica V4.1, 2,402–2,480 GHz Razred 2, največ +4 dBm
- glasbeni izhod: 2 x 2 W RMS
- razširjen vhod: Za zunanje stikalo (vklop radia/pripravljenost)
- okoljski pogoji:
  - relativna vlažnost: Delovanje: 10–75 % brez kondenzacije
  - skladiščenje: 5–90 %
  - temperatura: Delovanje: 5 °C – 35 °C
  - skladiščenje: -20 °C – 60 °C



BLUETOOTH



#### FLUSH MOUNTED RADIO + SPEAKER DAB BLUETOOTH

- power supply: 230 V~ / 50 Hz
- power consumption during normal operation: max. 6 W
- power consumption when on standby: < 0.5 W
- protection class: IP20
- reception frequencies: DAB/DAB+ 174.928 - 239.200 MHz FM: 87.5 - 108 MHz
- bluetooth: Version V4.1, 2.402-2.480 GHz Class 2, max. +4 dBm
- music output: 2 x 2W RMS
- extension input: For external switch (Switches radio on/ standby)
- ambient conditions
  - relative humidity: Operation: 10 % - 75 % non-condensing
  - storage: 5 % - 90 %
  - temperature: Operation: 5 °C - 35 °C
  - storage: -20 °C - 60 °C



- EQ02PWXO

#### PODOMETNI ZVOČNIK

- razred zaščite: IP20
- glasbena moč: 2 W RMS
- okoljski pogoji:
  - relativna vlažnost: Delovanje: 10–75 % brez kondenzacije
  - skladiščenje: 5–90 %
  - temperatura: Delovanje: 5–35 °C
  - skladiščenje: -20 °C – 60 °C



#### FLUSH MOUNTED SPEAKER

- protection class: IP20
- music power: 2W RMS
- ambient conditions
  - relative humidity: Operation: 10 % - 75 % non-condensing
  - storage: 5 % - 90 %
  - temperature: Operation: 5 °C - 35 °C
  - storage: -20 °C - 60 °C

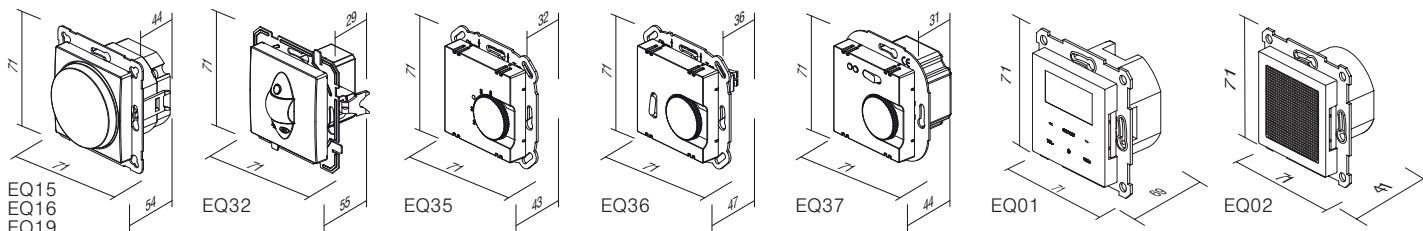

EQ15  
EQ16  
EQ19

EQ32

EQ35

EQ36

EQ37

EQ01

EQ02

## POLNILNIK USB PD 20W



- EQ69PWXO
- EQ69TIXO
- EQ69ATXO
- EQ69BKXO

- USB napajalnik z dovajanjem moči do 20W.
- za polnjenje elektronskih naprav prek standardnega USB priključka (kompatibilno tudi z Apple napravami)
- napajanje: 100-230 V~ 50/60 Hz
- poraba med delovanjem: 420 mA pri 100 V~/220 mA pri 230 V~
- poraba v mirovanju: <100 mW pri 230 V~
- izhodna moč: 20W Max

### Izhod:

- USB tip C: 5.0 VDC 3.0A; 9.0 VDC 2.2 A; 12.0 VDC 1.67 A (PD 20W)
- USB tip A: 5.0 VDC 3.0A; 9.0 VDC 2.0 A; 12.0 VDC 1.5 A (QC 18W)
- USB A+C: 5 VDC 3A
- tip konektorja: 1 x USB A; 1 x USB C
- povprečna učinkovitost v aktivnem stanju: 86 %
- učinkovitost pri minimalnem bremenu (10%): 81%
- temperatura delovanja: 0 °C/+ 45 °C (notranja uporaba)
- IP zaščitni razred: IP20, samo za notranjo uporabo
- varnostni razred naprave II
- prenapetostna zaščita (EN 60364-4-44): razred III
- vijačna pritrnitev vodnikov max. 2.5 mm<sup>2</sup>
- naprava z odmikom kontaktov min. 3 mm
- ni primeren za vgradnjo v doze globine 45 mm in ohišja CUBO IP20

### Ustreza:

Direktivam: BT, EMC, RoHS, ErP  
 Standardim: EN IEC 62368-1, EN 55032, EN55035, EN IEC 61000-3-2, EN 61000-3-3, EN 50563, EN IEC 63000  
 Dodatnim regulativam: (EU) n. 2019/1782 REACh, n. 1907/2006 – art.33.  
 Produkt lahko vsebuje sledi svinca.



## USB POWER SUPPLY UNIT PD 20W

- 20 W USB power delivery power supply unit
- for charging of electronic devices via a standard USB port (also compatible with Apple devices)
- power supply: 100-230V~ 50/60Hz
- power consumption: 420mA at 100V~/220mA at 230V~
- standby power consumption: <100mW at 230V~
- Output power: 20 W Max
- Output:
- USB tip C: 5.0 VDC 3.0A; 9.0 VDC 2.2 A; 12.0 VDC 1.67 A (PD 20W)
- USB tip A: 5.0 VDC 3.0A; 9.0 VDC 2.0 A; 12.0 VDC 1.5 A (QC 18W)
- USB A+C: 5 VDC 3A
- connector type: 1x USB A; 1x USB C
- average efficiency in active mode: 86%
- efficiency with low load (10%): 81%
- operating temperature: 0°C/+45°C (indoor use)
- IP protection class: IP20, indoor use only
- class device II
- overvoltage category (EN 60364-4-44): Class III
- screw contacts: max. 2.5 mm<sup>2</sup>
- device with a contact gap of at least 3mm
- Conformity:
- Directive: BT, EMC, RoHS, ErP
- Standards: EN IEC 62368-1, EN 55032, EN55035, EN IEC 61000-3-2, EN 61000-3-3, EN 50563, EN IEC 63000
- External power supplies regulation: (EU) n. 2019/1782 REACh, n. 1907/2006 – art.33. The product may contain traces of lead.

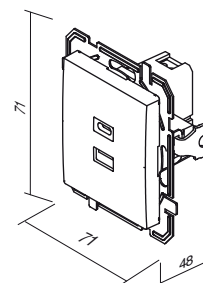

## A C C E S S O R I E S P Q

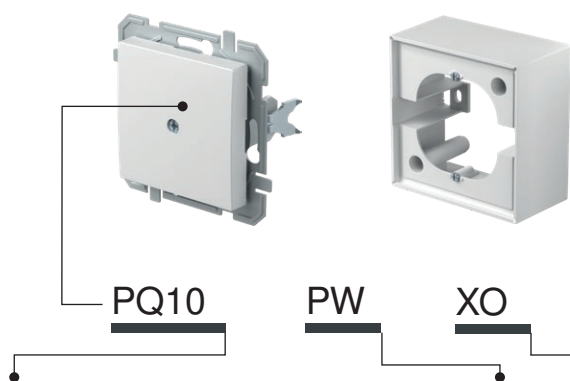

tip type	naziv description	barva colour	opcijski opis 1 optional data 1
PQ10	POLNILO BLANK	□ PW bela - sijaj polar white	XO brez okvirja without cover plate
PQ30	POKROV TAE/TDO COVER TAE/TDO	■ TI titan titanium ■ AT antracit anthracite ■ BK črna black	

## POLNILO



- PQ10PWXO
- PQ10TIXO
- PQ10ATXO
- PQ10BKXO

- za pokrivanje praznih odprtin  
*BLANK*  
- for filling up empty spaces



## POKROV TAE/TDO

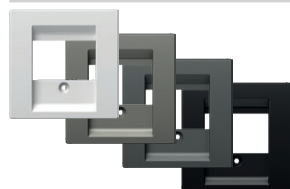

- PQ30PW
- PQ30TI
- PQ30AT
- PQ30BK

- TAE ali TDO pokrov z vijakom  
*COVER TAE/TDO*  
- TAE or TDO cover with screw

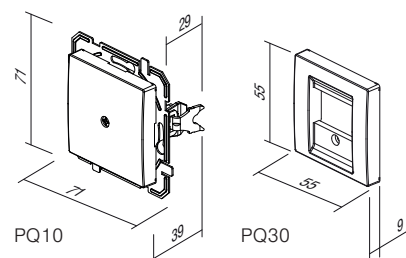

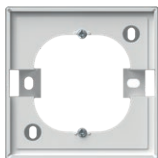

□ PQ20PWF

#### OHIŠJE NADOMETNO 1

- nadometno ohišje FLAT  
*SURFACE MOUNT BOX 1*  
- surface mounting box FLAT

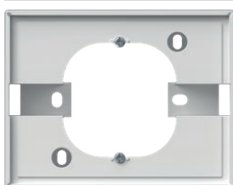

□ PQ21PWF

#### OHIŠJE NADOMETNO ZA DVOJNO VTIČNICO

- nadometno ohišje FLAT  
*SURFACE MOUNT BOX FOR DOUBLE SOCKET*  
- surface mounting box FLAT





- PQ22PWF
- PQ22TIF
- PQ22ATF
- PQ22BKF

#### SET ZA STIKALA FLAT IP44

- za vgradnjo v vlažne prostore
- IP44 zaščito zagotavlja za stikala LOGIQ (SQ10, SQ11, SQ22, SQ60, SQ70)
- stikala in tipke niso sestavni del seta
- okvir FLAT
- ustreza IEC 60669-1



#### SET SWITCHES FLAT IP44

- for usage in humid areas
- IP44 protection provides for LOGIQ switches (SQ10, SQ11, SQ22, SQ60, SQ70)
- switches and buttons are not part of the set
- FLAT cover plate
- in accordance with IEC 60669-1



- PQ23PWF
- PQ23TIF
- PQ23ATF
- PQ23BKF

#### SET ZA VTIČNICE FLAT IP44

- za vgradnjo v vlažne prostore
- IP44 zaščito zagotavlja le v kombinaciji z vtičnico s pokrovom (VQ11XO, VQ13XO, VQ41XO, VQ43XO)
- vtičnice niso sestavni del seta
- okvir FLAT
- ustreza IEC 60884-1



#### SOCKETS FLAT IP44



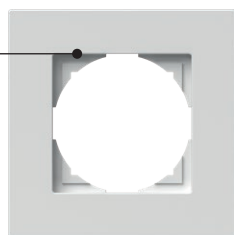

- for usage in humid areas
- IP44 protection can be achieved only in combination with covered socket (VQ11XO, VQ13XO, VQ41XO, VQ43XO)
- sockets are not part of the set
- FLAT cover plate
- in accordance with IEC 60884-1

# O K V I R J I F L A T O F







OF10

PW

tip type	naziv description	barva colour
OF10	OKVIR FLAT 1 COVER PLATE FLAT 1	 PW bela - sijaj polar white
OF20	OKVIR FLAT 2 COVER PLATE FLAT 2	 TI tian titanium
OF30	OKVIR FLAT 3 COVER PLATE FLAT 3	 AT antracit anthracite
:	:	 BK črna black

## OKVIR FLAT 1



	OF10PW
	OF10TI
	OF10AT
	OF10BK



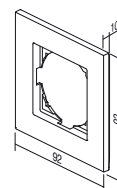

- dekorativni 1-mestni okvir  
- ustreza EN 60669-1

**COVER PLATE FLAT 1**  
- decorative cover plate 1-gang  
- in accordance with EN 60669-1



## OKVIR FLAT 2



	OF20PW
	OF20TI
	OF20AT
	OF20BK

- dekorativni 2-mestni okvir  
- ustreza EN 60669-1

**COVER PLATE FLAT 2**  
- decorative cover plate 2-gang  
- in accordance with EN 60669-1

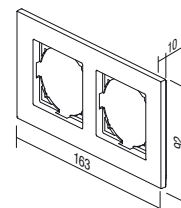







## C O V E R P L A T E S F L A T O F

## OKVIR FLAT 3



	OF30PW
	OF30TI
	OF30AT
	OF30BK



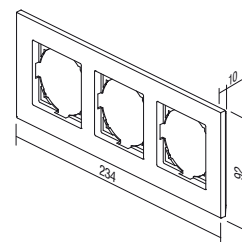

- dekorativni 3-mestni okvir  
- ustreza EN 60669-1

*COVER PLATE FLAT 3*  
- decorative cover plate 3-gang  
- in accordance with EN 60669-1



## OKVIR FLAT 4



	OF40PW
	OF40TI
	OF40AT
	OF40BK



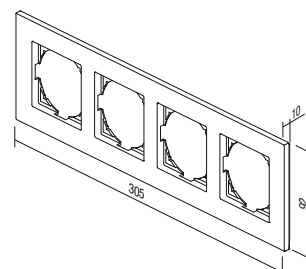

- dekorativni 4-mestni okvir  
- ustreza EN 60669-1

*COVER PLATE FLAT 4*  
- decorative cover plate 4-gang  
- in accordance with EN 60669-1



## OKVIR FLAT 5



	OF50PW
	OF50TI
	OF50AT
	OF50BK

- dekorativni 5-mestni okvir  
- ustreza EN 60669-1

*COVER PLATE FLAT 5*  
- decorative cover plate 5-gang  
- in accordance with EN 60669-1

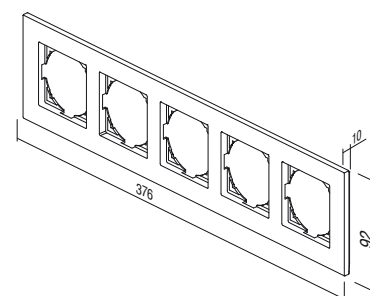





# O K V I R J I B O L D O Q







OQ10

PW

tip type	naziv description	barva colour
OQ10	OKVIR BOLD 1 COVER PLATE BOLD 1	 PW bela - sijaj polar white
OQ20	OKVIR BOLD 2 COVER PLATE BOLD 2	 TI titan titanium
OQ30	OKVIR BOLD 3 COVER PLATE BOLD 3	 AT antracit anthracite
:	:	 BK črna black

## OKVIR BOLD 1



	OQ10PW
	OQ10TI
	OQ10AT
	OQ10BK

- dekorativni 1-mestni okvir  
- ustreza EN 60669-1

*COVER PLATE BOLD 1*  
- decorative cover plate 1-gang  
- in accordance with EN 60669-1

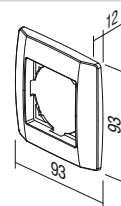

## OKVIR BOLD 2



	OQ20PW
	OQ20TI
	OQ20AT
	OQ20BK

- dekorativni 2-mestni okvir  
- ustreza EN 60669-1

*COVER PLATE BOLD 2*  
- decorative cover plate 2-gang  
- in accordance with EN 60669-1

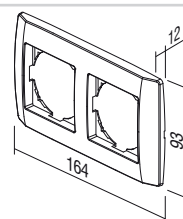

## COVER PLATES BOLD OQ

## OKVIR BOLD 3



	QQ30PW
	QQ30TI
	QQ30AT
	QQ30BK

- dekorativni 3-mestni okvir  
- ustreza EN 60669-1

**COVER PLATE BOLD 3**  
- decorative cover plate 3-gang  
- in accordance with EN 60669-1

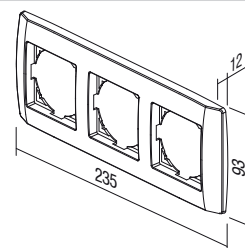

## OKVIR BOLD 4



	QQ40PW
	QQ40TI
	QQ40AT
	QQ40BK

- dekorativni 4-mestni okvir  
- ustreza EN 60669-1

**COVER PLATE BOLD 4**  
- decorative cover plate 4-gang  
- in accordance with EN 60669-1

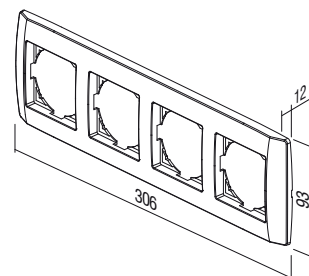

## OKVIR BOLD 5



	QQ50PW
	QQ50TI
	QQ50AT
	QQ50BK

- dekorativni 5-mestni okvir  
- ustreza EN 60669-1

**COVER PLATE BOLD 5**  
- decorative cover plate 5-gang  
- in accordance with EN 60669-1

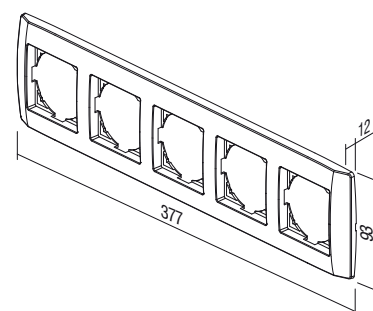

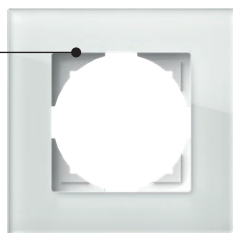

# O K V I R J I P R I M E O R



**OR10**

**PW**

tip type	naziv description	barva colour
OR10	OKVIR PRIME 1 COVER PLATE PRIME 1	 GL bela glass light
OR20	OKVIR PRIME 2 COVER PLATE PRIME 2	 GD črna glass dark
OR30	OKVIR PRIME 3 COVER PLATE PRIME 3	
⋮	⋮	
⋮	⋮	

## OKVIR PRIME 1



 OR10GL  
 OR10GD

- dekorativni 1-mestni okvir  
- ustreza EN 60669-1  
**COVER PLATE PRIME 1**  
- decorative cover plate 1-gang  
- in accordance with EN 60669-1

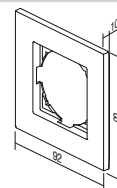

## OKVIR PRIME 2



 OR20GL  
 OR20GD

- dekorativni 2-mestni okvir  
- ustreza EN 60669-1  
**COVER PLATE PRIME 2**  
- decorative cover plate 2-gang  
- in accordance with EN 60669-1

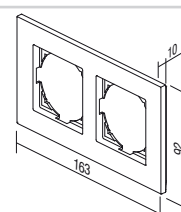

## C O V E R   P L A T E S   P R I M E   O R



OR30GL  
 OR30GD

**OKVIR PRIME 3**

- dekorativni 3-mestni okvir  
- ustreza EN 60669-1

**COVER PLATE PRIME 3**

- decorative cover plate 3-gang  
- in accordance with EN 60669-1

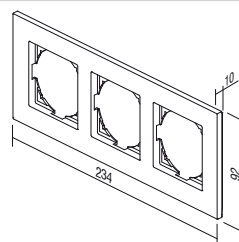

OR40GL  
 OR40GD

**OKVIR PRIME 4**

- dekorativni 4-mestni okvir  
- ustreza EN 60669-1

**COVER PLATE PRIME 4**

- decorative cover plate 4-gang  
- in accordance with EN 60669-1

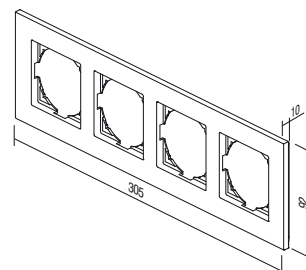

TEM

ekonomik





# ekonomik

## **NAČRTOVANO ZA ODLIČNOST** **Bistven je slog**

Nevtralen, kompakten, eleganten dizajn se prilagodi v vsako okolje, v katerem bivate ali delate. V interierju ne izstopa, temveč z njim harmonično zaživi.

## **PLANNED FOR EXCELLENCE** **Style is essential**

A neutral, compact, elegant design is adjustable to every working or living area. It does not stick out from the interior, but rather harmonically fits into it.







# ekonomik

## HARMONIJA BARV Izberi svoj odtenek

Želje so različne. Zato smo za vas pozorno izbrali možnosti, ki vam nudijo pravi odgovor. Nevtralna paleta barv bo le dopolnila vaš ambient - ne bo vas omejevala.

## HARMONY OF COLOURS Choose your hue

Desires can be very different. Therefore we have carefully selected possibilities for you, which can offer you the right answer. A neutral palette of colours will only complement your ambient - it will not restrict it.

<input type="checkbox"/> PW	<b>bela-sijaj</b>	<i>polar white</i>
<input type="checkbox"/> IW	<b>bež-sijaj</b>	<i>ivory white</i>
<input type="checkbox"/> ES	<b>srebrna-mat</b>	<i>elox silver</i>
<input type="checkbox"/> CO	<b>beli duroplast</b>	<i>white thermoset</i>
<input type="checkbox"/> NB	<b>črna sijaj</b>	<i>night black</i>





## PREPROSTO ZA NAJZAHTEVNEJŠE

S skrbnim načrtovanjem smo poskrbeli, da so elementi pod napetostjo zaščiteni pred dotikom. Osnovno pritrjevanje mehanizmov s krepeljci (1) lahko dodatno utrdite z vijaki (2). Ta način je še posebej primeren za varno in zanesljivo pritrnitev vtičnice.

## SIMPLE FOR THE MOST DEMANDING

By careful planning elements under voltage have been protected against touching. Basic fixing of mechanisms with fixing claws (1) allows additional strengthening with screws (2). This manner is especially appropriate for safe and reliable fixing of sockets.

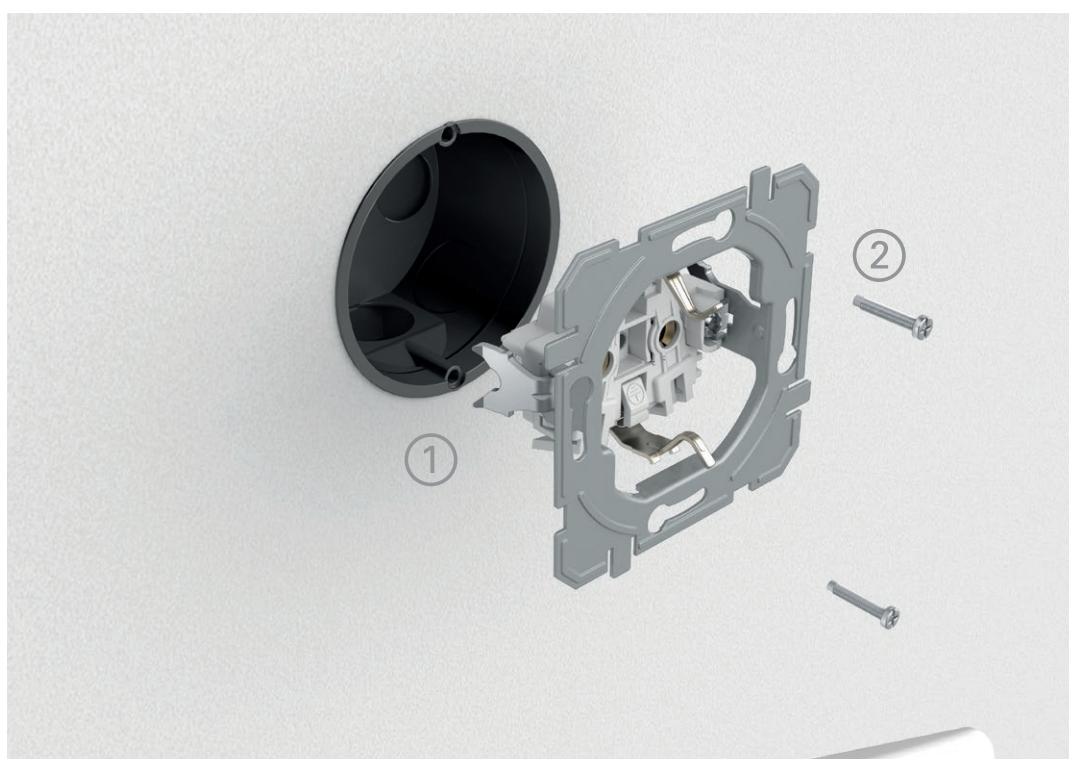

**KOMBINIRAJTE KOT SAMI ŽELITE.**  
COMBINE AS YOU PLEASE.

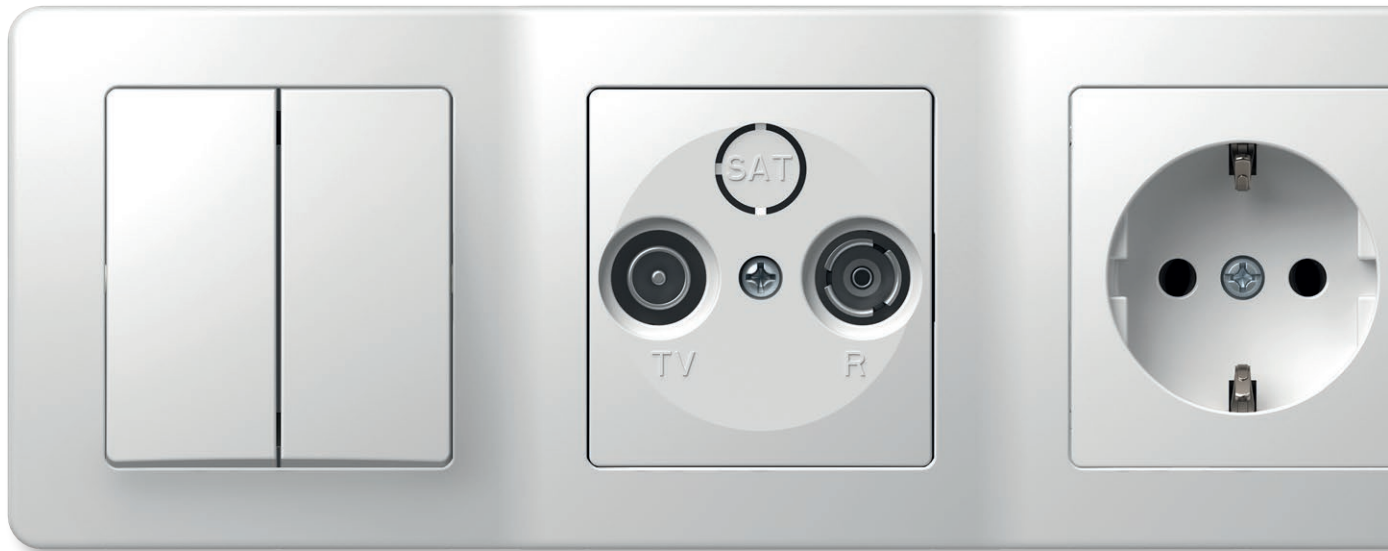

S sestavljanjem prihranite prostor na steni.  
Ko imate malo prostora, je navpično prava  
odločitev.

With combining you save space on the wall.  
When faced with a limited space, »vertically«  
is the right decision.

## ENOSTAVNA MONTAŽA

Ekonomik je rešitev za sistem standardnih okroglih doz. Z njim lahko načrtujete tako enostavne kot tudi zahtevnejše inštalacije, novogradnje in adaptacije. Sistem odlikujejo brezvijačni kontakti, ki vam prihranijo čas pri vgradnji elementov.

## EASY INSTALLATION

Ekonomik is a solution for the system of standardized round installations boxes. It can be used for simple as well as more demanding installations, new buildings and adaptations. The system is characterised by plug-in contacts which save time during installation of elements.

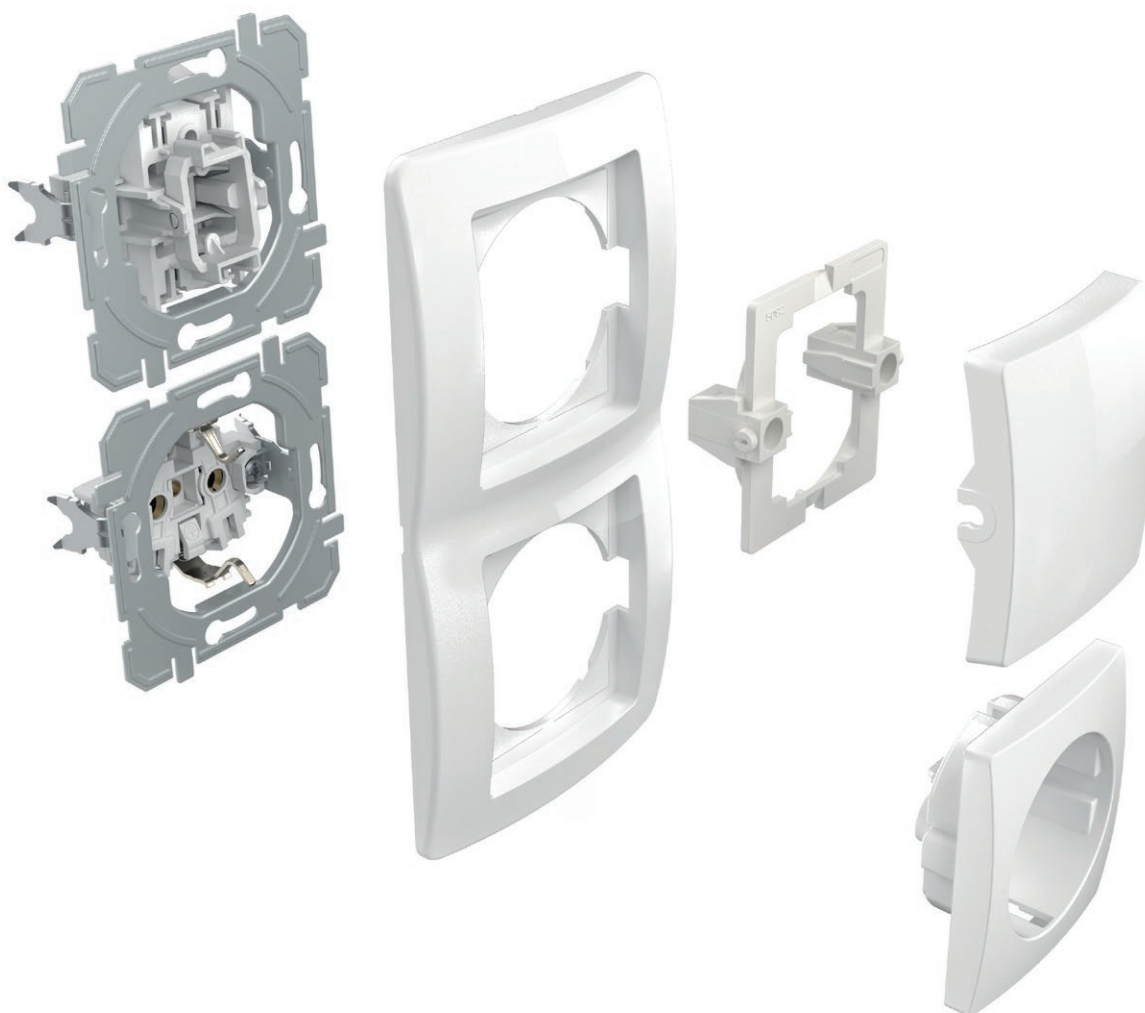

## DOBRO JE VEDETI

### GOOD TO KNOW



Vse vtičnice imajo vgrajeno varovalo pred dotikom elementov pod napetostjo.

*All the sockets are equipped with a safety shutters assuring the protection to live contacts.*



Dobro premišljena konstrukcija stikala omogoča enostavno indikacijo tudi naknadno.

*The well-thought-out design of the switch enables the easy integration of the indication, including at a later time.*



Za zanesljivost preklopa skrbijo kontakti iz srebrve zlitine.

*Contacts made of silver alloy guarantee safe switching.*



Brezvijačni kontakti omogočajo hitro in zanesljivo priključitev vodnikov. Na isti kontakt lahko pritrdite dva vodnika različnih premerov.

*Plug-in contacts enable quick and reliable attachment of wires. Two wires of different diameters can be attached to the same contact.*



Krepeljci omogočajo globljo pritrditev (tudi preko keramičnih ploščic ipd.).

*Fixing claws enable deeper fixing (also through ceramic tiles, etc.)*



Sestavljive doze vam bodo olajšale delo. Prave razdalje so vam zagotovljene.

*Easy-fitting installation boxes will make your work easier. Proper lengths are guaranteed.*

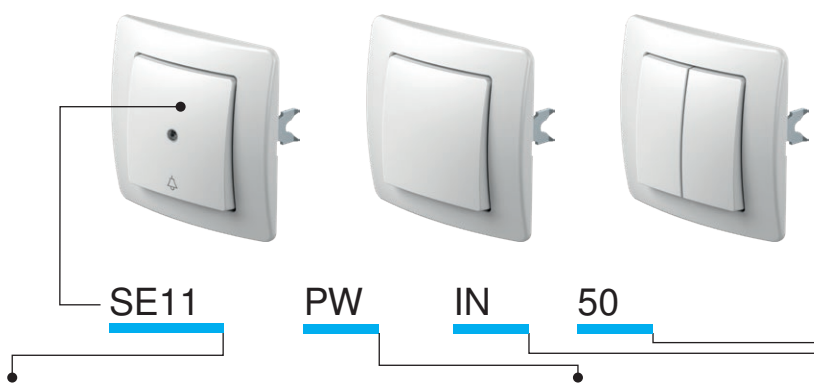

tip type	naziv description	tehnični opis technical data	barva colour	opcijski opis 1 optional data 1	opcijski opis 2 optional data 2
SE10	STIKALO ENOPOLNO SWITCH 1WAY	10AX 250V~	<input type="checkbox"/> PW bela-sijaj polar white	NT nevtral neutral	50
SE11	TIPKALO ENOPOLNO PUSH BUTTON 1WAY	10A 250V~	<input type="checkbox"/> IW bež-sijaj ivory white	IN indikator indicator	51
SE22	STIKALO DVOPOLNO SWITCH 2POLE	16AX 250V~	<input type="checkbox"/> ES srebrna-mat elox silver		03
...	...	...	<input type="checkbox"/> CO beli duroplast white thermoset		04
...	...	...	<input type="checkbox"/> NB črna-sijaj night black		...

STIKALO ENOPOLNO 10AX 250V~

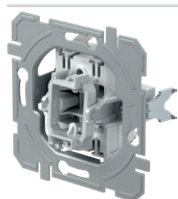

SE10

- 10AX 250V~, tip SE10
- ustreza EN 60669-1
- brezvijačna pritrditev vodnikov 1.5-2.5mm<sup>2</sup>

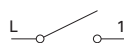

- SWITCH 1WAY 10AX 250V~
- 10AX 250V~, type SE10
- in accordance with EN 60669-1
- plug-in contacts 1.5-2.5mm<sup>2</sup>

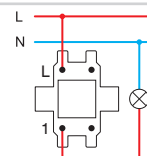

TIPKALO ENOPOLNO 10A 250V~

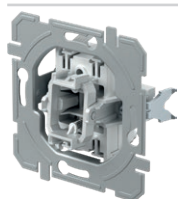

SE11

- 10A 250V~, tip SE11
- ustreza EN 60669-1
- brezvijačna pritrditev vodnikov 1.5-2.5mm<sup>2</sup>



- PUSH BUTTON 1WAY 10A 250V~
- 10A 250V~, type SE11
- in accordance with EN 60669-1
- plug-in contacts 1.5-2.5mm<sup>2</sup>

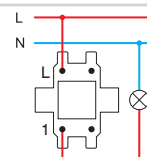

STIKALO DVOPOLNO 16AX 250V~

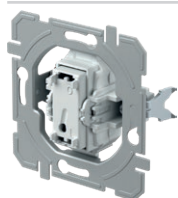

SE22

- 16AX 250V~, tip SE22
- ustreza EN 60669-1
- vijajna pritrditev vodnikov 1.5-2.5mm<sup>2</sup>
- samo v kombinaciji s tipko TE10\_NT03

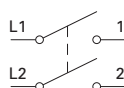

- SWITCH 2POLE 16AX 250V~
- 16AX 250V~, type SE22
- in accordance with EN 60669-1
- screw contacts 1.5-2.5mm<sup>2</sup>
- only in combination with button TE10\_NT03

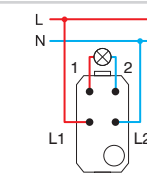

STIKALO SERIJSKO 10AX 250V~

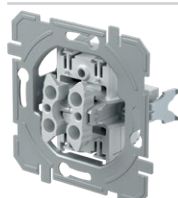

SE50

- 10AX 250V~, tip SE50
- ustreza EN 60669-1
- brezvijačna pritrditev vodnikov 1.5-2.5mm<sup>2</sup>

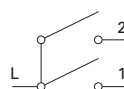

- SWITCH 2GANG-1WAY 10AX 250V~
- 10AX 250V~, type SE50
- in accordance with EN 60669-1
- plug-in contacts 1.5-2.5mm<sup>2</sup>

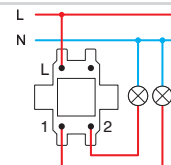



## S W I T C H E S S E

## TIPKALO SERIJSKO 10A 250V~

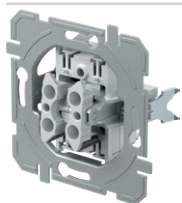

SE51

- 10A 250V~, tip SE51
- ustreza EN 60669-1
- brezvijačna pritrditev vodnikov 1.5-2.5mm<sup>2</sup>

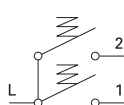
*PUSH BUTTON 2GANG-1WAY 10A 250V~*

- 10A 250V~, type SE51
- in accordance with EN 60669-1
- plug-in contacts 1.5-2.5mm<sup>2</sup>

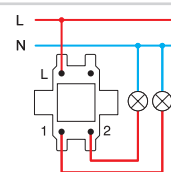

## STIKALO ŽALUZIJSKO 10AX 250V~

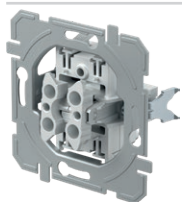

SE52

- 10AX 250V~, tip SE52
- ustreza EN 60669-1
- brezvijačna pritrditev vodnikov 1.5-2.5mm<sup>2</sup>
- z mehansko blokado hkratnega vklopa

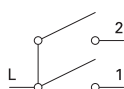
*SWITCH SHUTTERS 10AX 250V~*

- 10AX 250V~, type SE52
- in accordance with EN 60669-1
- plug-in contacts 1.5-2.5mm<sup>2</sup>
- with mechanical interblock

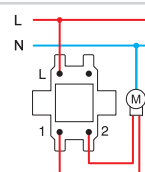

## TIPKALO ŽALUZIJSKO 10A 250V~

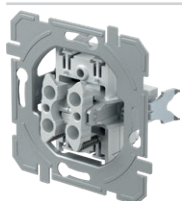

SE53

- 10A 250V~, tip SE53
- ustreza EN 60669-1
- brezvijačna pritrditev vodnikov 1.5-2.5mm<sup>2</sup>
- z mehansko blokado hkratnega vklopa

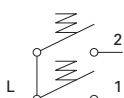
*PUSH BUTTON SHUTTERS 10A 250V~*

- 10A 250V~, type SE53
- in accordance with EN 60669-1
- plug-in contacts 1.5-2.5mm<sup>2</sup>
- with mechanical interblock

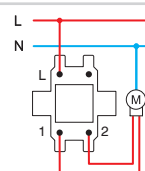

## STIKALO MENJALNO 10AX 250V~

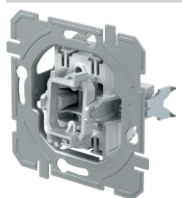

SE60

- 10AX 250V~, tip SE60
- ustreza EN 60669-1
- brezvijačna pritrditev vodnikov 1.5-2.5mm<sup>2</sup>

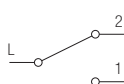
*SWITCH 2WAY 10AX 250V~*

- 10AX 250V~, type SE60
- in accordance with EN 60669-1
- plug-in contacts 1.5-2.5mm<sup>2</sup>

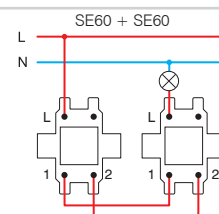

## STIKALO DVOJNO MENJALNO 10AX 250V~

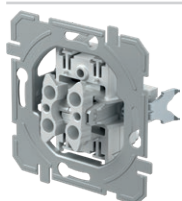

SE63

- 10AX 250V~, tip SE63
- ustreza EN 60669-1
- brezvijačna pritrditev vodnikov 1.5-2.5mm<sup>2</sup>

*SWITCH DOUBLE 2WAY 10AX 250V~*

- 10AX 250V~, type SE63
- in accordance with EN 60669-1
- plug-in contacts 1.5-2.5mm<sup>2</sup>

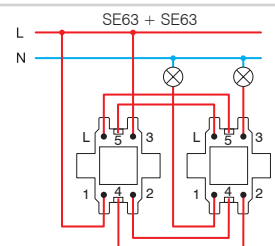

## STIKALO KRIŽNO 10AX 250V~

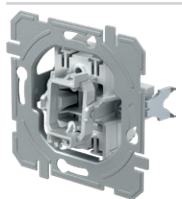

SE70

- 10AX 250V~, tip SE70
- ustreza EN 60669-1
- brezvijačna pritrditev vodnikov 1.5-2.5mm<sup>2</sup>

*SWITCH INTERMEDIATE 10AX 250V~*

- 10AX 250V~, type SE70
- in accordance with EN 60669-1
- plug-in contacts 1.5-2.5mm<sup>2</sup>

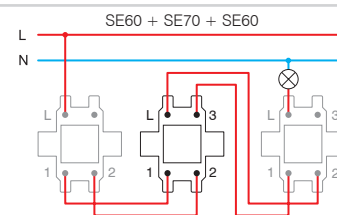

STIKALO ENOPOLNO 10AX 250V~



- SE10PW
- SE10IW
- SE10ES
- SE10CO
- SE10NB

- 10AX 250V~, tip SE10  
 - ustreza EN 60669-1  
 - brezvijačna pritržitev vodnikov 1.5-2.5mm<sup>2</sup>

*SWITCH 1WAY 10AX 250V~*  
 - 10AX 250V~, type SE10  
 - in accordance with EN 60669-1  
 - plug-in contacts 1.5-2.5mm<sup>2</sup>



STIKALO ENOPOLNO 10AX 250V~ \_\_ IN



- SE10PWIN
- SE10IWIN
- SE10ESIN
- SE10COIN
- SE10NBIN

- IN indikator  
 - 10AX 250V~, tip SE10  
 - ustreza EN 60669-1  
 - brezvijačna pritržitev vodnikov 1.5-2.5mm<sup>2</sup>

*SWITCH 1WAY 10AX 250V~ \_\_ IN*  
 - IN indicator  
 - 10AX 250V~, type SE10  
 - in accordance with EN 60669-1  
 - plug-in contacts 1.5-2.5mm<sup>2</sup>



TIPKALO ENOPOLNO 10A 250V~



- SE11PW
- SE11IW
- SE11ES
- SE11CO
- SE11NB

- 10A 250V~, tip SE11  
 - ustreza EN 60669-1  
 - brezvijačna pritržitev vodnikov 1.5-2.5mm<sup>2</sup>

*PUSH BUTTON 1WAY 10A 250V~*  
 - 10A 250V~, type SE11  
 - in accordance with EN 60669-1  
 - plug-in contacts 1.5-2.5mm<sup>2</sup>



TIPKALO ENOPOLNO 10A 250V~ \_\_ TI 50



- SE11PWTI50
- SE11IWTI50
- SE11ESTI50
- SE11COTI50
- SE11NBTI50

- TI 50 indikator zvonec+tlivka  
 - 10A 250V~, tip SE11  
 - ustreza EN 60669-1  
 - brezvijačna pritržitev vodnikov 1.5-2.5mm<sup>2</sup>

*PUSH BUTTON 1WAY 10A 250V~ \_\_ TI 50*  
 - TI 50 indicator bell+neon lamp  
 - 10A 250V~, type SE11  
 - in accordance with EN 60669-1  
 - plug-in contacts 1.5-2.5mm<sup>2</sup>



TIPKALO ENOPOLNO 10A 250V~ \_\_ TI 51



- SE11PWTI51
- SE11IWTI51
- SE11ESTI51
- SE11COTI51
- SE11NBTI51

- TI 51 indikator luč+tlivka  
 - 10A 250V~, tip SE11  
 - ustreza EN 60669-1  
 - brezvijačna pritržitev vodnikov 1.5-2.5mm<sup>2</sup>

*PUSH BUTTON 1WAY 10A 250V~ \_\_ TI 51*  
 - TI 51 indicator light+neon lamp  
 - 10A 250V~, type SE11  
 - in accordance with EN 60669-1  
 - plug-in contacts 1.5-2.5mm<sup>2</sup>



TIPKALO ENOPOLNO 10A 250V~ \_\_ IL



- SE11PWIL
- SE11IWIL
- SE11ESIL
- SE11COIL
- SE11NBIL

- IL napisna ploščica  
 - 10A 250V~, tip SE11  
 - ustreza EN 60669-1  
 - brezvijačna pritržitev vodnikov 1.5-2.5mm<sup>2</sup>

*PUSH BUTTON 1WAY 10A 250V~ \_\_ IL*  
 - IL inscription plate  
 - 10A 250V~, type SE11  
 - in accordance with EN 60669-1  
 - plug-in contacts 1.5-2.5mm<sup>2</sup>



STIKALO DVOPOLNO 16AX 250V~ \_\_ IN 03



- SE22PWIN03
- SE22IWIN03
- SE22ESIN03
- SE22NBIN03

- IN 03 nevtral 0-1  
 - 16AX 250V~, tip SE22  
 - ustreza EN 60669-1  
 - vijaka pritržitev vodnikov 1.5-2.5mm<sup>2</sup>

*SWITCH 2POLE 16AX 250V~ \_\_ IN 03*  
 - IN 03 neutral 0-1  
 - 16AX 250V~, type SE22  
 - in accordance with EN 60669-1  
 - screw contacts 1.5-2.5mm<sup>2</sup>





- SE50PW
- SE50IW
- SE50ES
- SE50CO
- SE50NB

## STIKALO SERIJSKO 10AX 250V~

- 10AX 250V~, tip SE50
- ustreza EN 60669-1
- brezvijačna pritrditve vodnikov 1.5-2.5mm<sup>2</sup>

## SWITCH 2GANG-1WAY 10AX 250V~

- 10AX 250V~, type SE50
- in accordance with EN 60669-1
- plug-in contacts 1.5-2.5mm<sup>2</sup>



- SE51PW
- SE51IW
- SE51ES
- SE51CO
- SE51NB

## TIPKALO SERIJSKO 10A 250V~

- 10A 250V~, tip SE51
- ustreza EN 60669-1
- brezvijačna pritrditve vodnikov 1.5-2.5mm<sup>2</sup>

## PUSH BUTTON 2GANG-1WAY 10A 250V~

- 10A 250V~, type SE51
- in accordance with EN 60669-1
- plug-in contacts 1.5-2.5mm<sup>2</sup>



- SE52PWNT09
- SE52IWNT09
- SE52ESNT09
- SE52CONT09
- SE52NBNT09

## STIKALO ŽALUZIJSKO 10AX 250V~ \_\_ NT 09

- NT 09 nevtral gor-dol
- 10AX 250V~, tip SE52
- ustreza EN 60669-1
- brezvijačna pritrditve vodnikov 1.5-2.5mm<sup>2</sup>
- z mehansko blokado hkratnega vklopa

## SWITCH SHUTTERS 10AX 250V~ \_\_ NT 09

- NT 09 neutral up-down
- 10AX 250V~, type SE52
- in accordance with EN 60669-1
- plug-in contacts 1.5-2.5mm<sup>2</sup>
- with mechanical interblock



- SE53PWNT09
- SE53IWNT09
- SE53ESNT09
- SE53CONT09
- SE53NBNT09

## TIPKALO ŽALUZIJSKO 10A 250V~ \_\_ NT 09

- NT 09 nevtral gor-dol
- 10A 250V~, tip SE53
- ustreza EN 60669-1
- brezvijačna pritrditve vodnikov 1.5-2.5mm<sup>2</sup>
- z mehansko blokado hkratnega vklopa

## PUSH BUTTON SHUTTERS 10A 250V~ \_\_ NT 09

- NT 09 neutral up-down
- 10A 250V~, type SE53
- in accordance with EN 60669-1
- plug-in contacts 1.5-2.5mm<sup>2</sup>
- with mechanical interblock



- SE60PW
- SE60IW
- SE60ES
- SE60CO
- SE60NB

## STIKALO MENJALNO 10AX 250V~

- 10AX 250V~, tip SE60
- ustreza EN 60669-1
- brezvijačna pritrditve vodnikov 1.5-2.5mm<sup>2</sup>

## SWITCH 2WAY 10AX 250V~

- 10AX 250V~, type SE60
- in accordance with EN 60669-1
- plug-in contacts 1.5-2.5mm<sup>2</sup>



- SE63PW
- SE63IW
- SE63ES
- SE63CO
- SE63NB

## STIKALO DVOJNO MENJALNO 10AX 250V~

- 10AX 250V~, tip SE63
- ustreza EN 60669-1
- brezvijačna pritrditve vodnikov 1.5-2.5mm<sup>2</sup>

## SWITCH DOUBLE 2WAY 10AX 250V~

- 10AX 250V~, type SE63
- in accordance with EN 60669-1
- plug-in contacts 1.5-2.5mm<sup>2</sup>



- SE70PW
- SE70IW
- SE70ES
- SE70CO
- SE70NB

## STIKALO KRIŽNO 10AX 250V~



- 10AX 250V~, tip SE70
- ustreza EN 60669-1
- brezvijačna pritrditve vodnikov 1.5-2.5mm<sup>2</sup>

## SWITCH INTERMEDIATE 10AX 250V~

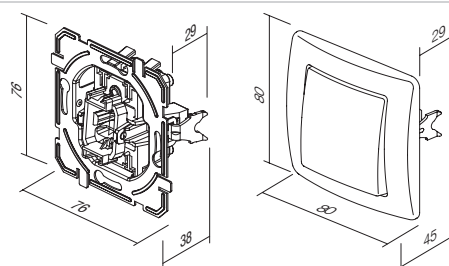
- 10AX 250V~, type SE70
- in accordance with EN 60669-1
- plug-in contacts 1.5-2.5mm<sup>2</sup>

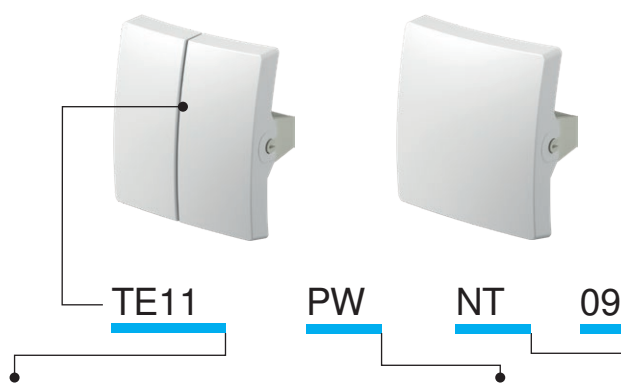



tip type	naziv description	barva colour	opcijski opis 1 optional data 1	opcijski opis 2 optional data 2
TE10	TIPKA NAVADNA BUTTON 1GANG	<input type="checkbox"/> PW bela-sijaj polar white	 NT nevtral neutral	 50
TE11	TIPKA SERIJSKA BUTTON 2GANG	<input type="checkbox"/> IW bež-sijaj ivory white	 IN indikator indicator	 51
...	...	<input type="checkbox"/> ES srebrna-mat elox silver		 03
...	...	<input type="checkbox"/> CO beli duroplast white thermoset		 04
...	...	<input type="checkbox"/> NB črna-sijaj night black		...

**TIPKA NAVADNA**  
- tipka skupaj z nosilcem  
*BUTTON 1GANG*  
- button together with carrier



- TE10PW
- TE10IW
- TE10ES
- TE10CO
- TE10NB



**TIPKA INDIKATOR**  
- tipka skupaj z nosilcem  
*BUTTON INDICATOR*  
- button together with carrier



- TE10PWIN
- TE10IWIN
- TE10ESIN
- TE10COIN
- TE10NBIN



**TIPKA Z NAPISNO PLOŠČICO**  
- tipka skupaj z nosilcem, z napisno ploščico  
*BUTTON WITH INSCRIPTION PLATE*  
- button together with carrier, with inscription plate



- TE13PWIL
- TE13IWIL
- TE13ESIL
- TE13NBIL



**TIPKA SERIJSKA**  
- tipka serijska skupaj z nosilcem  
*BUTTON 2GANG*  
- button 2gang together with carrier



- TE11PW
- TE11IW
- TE11ES
- TE11CO
- TE11NB

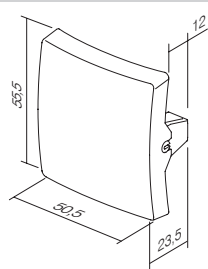
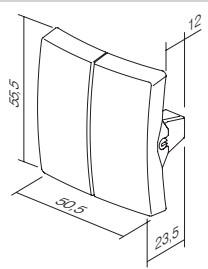

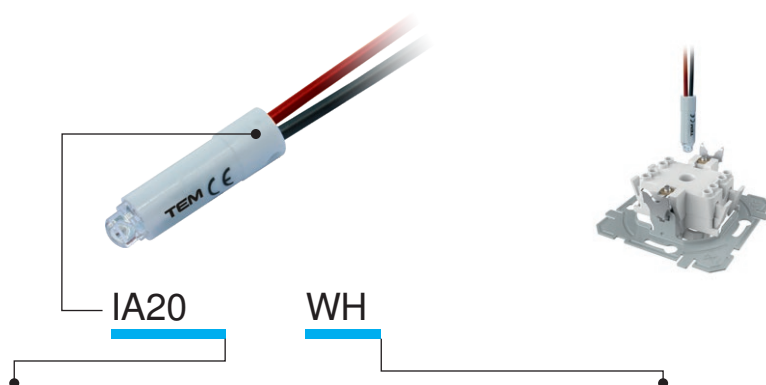

## S I G N A L I Z A T I O N I A

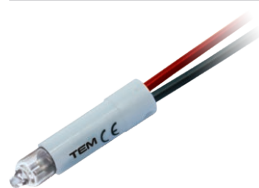

tip type	naziv description	tehnični opis technical data	barva colour
IA10	TLIVKA NEON LAMP	230V~ 0,34W	<input type="checkbox"/> WH bela white
IA20	LED SIGNALIZACIJA LED SIGNALLING UNIT	230V~ 0,40W	<input checked="" type="checkbox"/> BL modra blue
IA21	LED SIGNALIZACIJA LED SIGNALLING UNIT	24V AC/DC 0,20W	<input checked="" type="checkbox"/> RD rdeča red
·	·	·	<input checked="" type="checkbox"/> GR zelena green
·	·	·	<input checked="" type="checkbox"/> OR oranžna orange

## TLIVKA 230V~ 0,34W



 IA10OR

- za indikacijo, signalizacijo ali stalno signalizacijo stikala
- v kombinaciji s tipko z indikatorjem

## NEON LAMP 230V~ 0,34W

- for indication, signalling or permanent signalling
- in combination with a button featuring an indicator

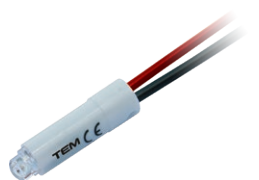
## LED SIGNALIZACIJA 230V AC/DC 0,40W



 IA20WH  
 IA20GR  
 IA20RD  
 IA20BL

- za indikacijo, signalizacijo ali stalno signalizacijo stikala
- v kombinaciji s tipko z indikatorjem

## LED SIGNALLING UNIT 230V AC/DC 0,40W

- for indication, signalling or permanent signalling
- in combination with a button featuring an indicator

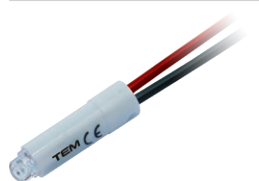
## LED SIGNALIZACIJA 24V AC/DC 0,20W



 IA21WH  
 IA21RD

- za indikacijo, signalizacijo ali stalno signalizacijo stikala
- v kombinaciji s tipko z indikatorjem

## LED SIGNALLING UNIT 24V AC/DC 0,20W

- for indication, signalling or permanent signalling
- in combination with a button featuring an indicator

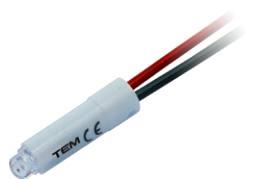
## LED SIGNALIZACIJA 12V AC/DC 0,10W

 IA22WH  
 IA22RD

- za indikacijo, signalizacijo ali stalno signalizacijo stikala
- v kombinaciji s tipko z indikatorjem

## LED SIGNALLING UNIT 12V AC/DC 0,10W

- for indication, signalling or permanent signalling
- in combination with a button featuring an indicator

Indikacija /  
Indication

\* Signalizacija /  
Signalization

Stalna signalizacija /  
Permanent signalling

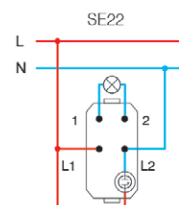
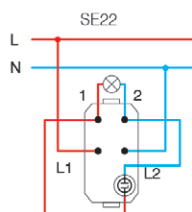
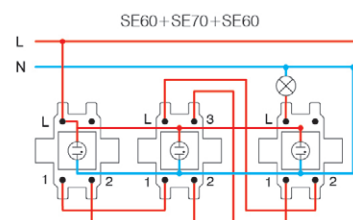
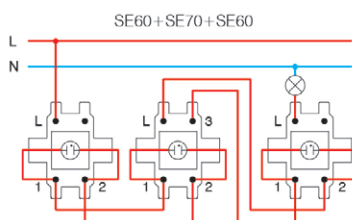
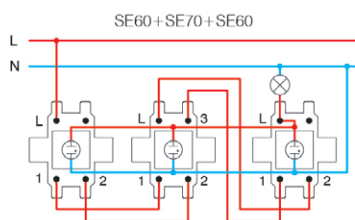
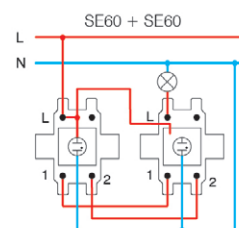
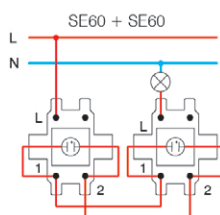
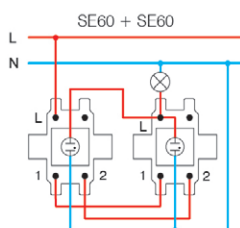
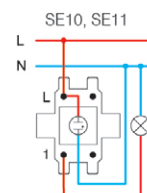
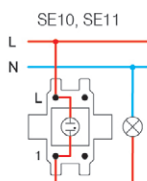
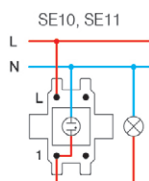

\* vezave niso primerne za varčne (CFL, LED) sijalke /  
the connections are not suitable for energy-saving bulbs (CFL, LED)

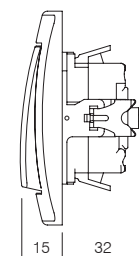

## S O C K E T S V E



VE11



PT

XO

KS



tip type	naziv description	tehnični opis technical data	opsijski opis 1 optional data 1	opsijski opis 2 optional data 2
VE10	VTIČNICA SCHUKO SOCKET SCHUKO	2P+E 16A 250V~	XO brez okvirja without cover plate	KS vgrajena zaščita pred dotikom kontaktov shuttered live contacts
VE11	VTIČNICA SCHUKO+POKROV SOCKET SCHUKO+COVER	2P+E 16A 250V~		
VE12	VTIČNICA SCHUKO SOCKET SCHUKO	2P+E 16A 250V~ BV	KS vgrajena zaščita pred dotikom kontaktov shuttered live contacts	
⋮	⋮	⋮		

barva  
colour

<input type="checkbox"/> PW bela-sijaj polar white	<input checked="" type="checkbox"/> PT bela+prozorna white+transparent	<input type="checkbox"/> PP bela+bela white+white
<input checked="" type="checkbox"/> IW bež-sijaj ivory white	<input checked="" type="checkbox"/> IT bež+prozorna ivory+transparent	<input checked="" type="checkbox"/> II bež+bež ivory+ivory
<input type="checkbox"/> ES srebrna-mat elox silver	<input checked="" type="checkbox"/> ST srebrna+prozorna silver+transparent	<input type="checkbox"/> SS srebrna+srebrna silver+silver
<input type="checkbox"/> CO beli duroplast white thermoset	<input type="checkbox"/> CT bela+prozorna white+transparent	<input type="checkbox"/> BB črna+črna black+black
<input checked="" type="checkbox"/> NB črna-sijaj night black	<input checked="" type="checkbox"/> BT črna+prozorna black+transparent	<input checked="" type="checkbox"/> RR rdeča+rdeča red+red
<input checked="" type="checkbox"/> RD rdeča red	<input checked="" type="checkbox"/> RT rdeča+prozorna red+transparent	<input checked="" type="checkbox"/> GG zelena+zelena green+green
<input checked="" type="checkbox"/> GR zelena green	<input checked="" type="checkbox"/> GT zelena+prozorna green+transparent	<input checked="" type="checkbox"/> OO oranžna+oranžna orange+orange
<input checked="" type="checkbox"/> OR oranžna orange	<input checked="" type="checkbox"/> OT oranžna+prozorna orange+transparent	



schuko - ustreza EN 60884-1, CEE7 (list III)

francoska - ustreza NF C 61-314 (list V)

schuko - in accordance with EN 60884-1, CEE7 (standard sheet III)

French - in accordance with NF C 61-314 (standard sheet V)

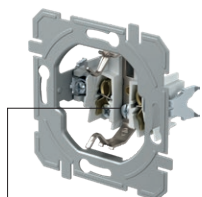
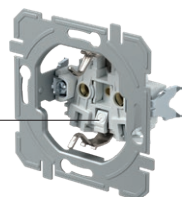
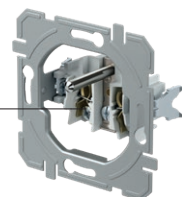
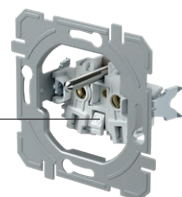
vijačna pritrditev vodnikov  
screw contactsBV brezvijačna pritrditev vodnikov  
BV plug-in contactsvijačna pritrditev vodnikov  
screw contactsBV brezvijačna pritrditev vodnikov  
BV plug-in contacts

VTIČNICA SCHUKO 2P+E 16A 250V~ \_\_ XO



- VE10PWXO
- VE10IWXO
- VE10ESXO
- VE10COXO
- VE10NBXO
- VE10RDXO
- VE10GRXO
- VE10ORXO

- vijajna pritrditvev vodnikov 1.5-2.5mm<sup>2</sup>
- XO brez okvirja
- 2P+E schuko
- 16A 250V~, tip VE10

SOCKET SCHUKO 2P+E 16A 250V~ \_\_ XO

- screw contacts 1.5-2.5mm<sup>2</sup>
- XO without surround
- 2P+E schuko
- 16A 250V~, type VE10



VTIČNICA SCHUKO+POKROV 2P+E 16A 250V~ \_\_ XO

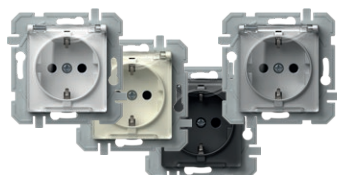

- VE11PTXO
- VE11ITXO
- VE11STXO
- VE11BTXO

- vijajna pritrditvev vodnikov 1.5-2.5mm<sup>2</sup>
- XO brez okvirja
- 2P+E schuko+pokrov
- 16A 250V~, tip VE11

SOCKET SCHUKO+COVER 2P+E 16A 250V~ \_\_ XO

- screw contacts 1.5-2.5mm<sup>2</sup>
- XO without surround
- 2P+E schuko+cover
- 16A 250V~, type VE11



VTIČNICA SCHUKO 2P+E 16A 250V~ BV \_\_ XO

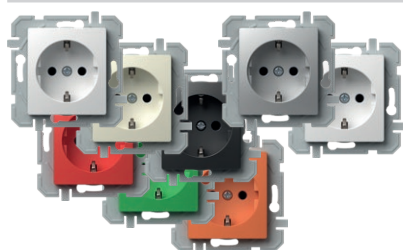

- VE12PWXO
- VE12IWXO
- VE12ESXO
- VE12COXO
- VE12NBXO
- VE12RDXO
- VE12GRXO
- VE12ORXO

- BV brezvijajna pritrditvev vodnikov 1.5-2.5mm<sup>2</sup>
- XO brez okvirja
- 2P+E schuko
- 16A 250V~, tip VE12

SOCKET SCHUKO 2P+E 16A 250V~ BV \_\_ XO

- BV plug-in contacts 1.5-2.5mm<sup>2</sup>
- XO without surround
- 2P+E schuko
- 16A 250V~, type VE12



VTIČNICA SCHUKO+POKROV 2P+E 16A 250V~ BV \_\_ XO



- VE13PTXO
- VE13ITXO
- VE13STXO
- VE13BTXO
- VE13PPXO

- BV brezvijajna pritrditvev vodnikov 1.5-2.5mm<sup>2</sup>
- XO brez okvirja
- 2P+E schuko+pokrov
- 16A 250V~, tip VE13

SOCKET SCHUKO+COVER 2P+E 16A 250V~ BV \_\_ XO

- BV plug-in contacts 1.5-2.5mm<sup>2</sup>
- XO without surround
- 2P+E schuko+cover
- 16A 250V~, type VE13



VTIČNICA SCHUKO 2P+E 16A 250V~



- VE10PW
- VE10IW
- VE10ES
- VE10CO
- VE10NB

- vijajna pritrditvev vodnikov 1.5-2.5mm<sup>2</sup>
- 2P+E schuko
- 16A 250V~, tip VE10

SOCKET SCHUKO 2P+E 16A 250V~

- screw contacts 1.5-2.5mm<sup>2</sup>
- 2P+E schuko
- 16A 250V~, type VE10



VTIČNICA SCHUKO+POKROV 2P+E 16A 250V~



- VE11PT
- VE11IT
- VE11ST
- VE11CT
- VE11BT

- vijajna pritrditvev vodnikov 1.5-2.5mm<sup>2</sup>
- 2P+E schuko+pokrov
- 16A 250V~, tip VE11

SOCKET SCHUKO+COVER 2P+E 16A 250V~

- screw contacts 1.5-2.5mm<sup>2</sup>
- 2P+E schuko+cover
- 16A 250V~, type VE11



VTIČNICA SCHUKO 2P+E 16A 250V~ BV



- VE12PW
- VE12IW
- VE12ES
- VE12CO
- VE12NB

- BV brezvijajna pritrditvev vodnikov 1.5-2.5mm<sup>2</sup>
- 2P+E schuko
- 16A 250V~, tip VE12

SOCKET SCHUKO 2P+E 16A 250V~ BV

- BV plug-in contacts 1.5-2.5mm<sup>2</sup>
- 2P+E schuko
- 16A 250V~, type VE12



VTIČNICA SCHUKO+POKROV 2P+E 16A 250V~ BV



- VE13PT
- VE13IT
- VE13ST
- VE13CT
- VE13BT

- BV brezvijajna pritrditvev vodnikov 1.5-2.5mm<sup>2</sup>
- 2P+E schuko+pokrov
- 16A 250V~, tip VE13

SOCKET SCHUKO+COVER 2P+E 16A 250V~ BV

- BV plug-in contacts 1.5-2.5mm<sup>2</sup>
- 2P+E schuko+cover
- 16A 250V~, type VE13





## S O C K E T S      V E

## VTIČNICA FRANCOSKA 2P+E 16A 250V~ \_\_ XO

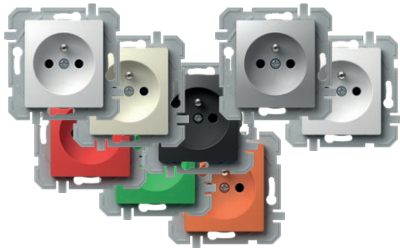

- VE40PWXO
- VE40IWXO
- VE40ESXO
- VE40COXO
- VE40NBXO
- VE40RDXO
- VE40GRXO
- VE40ORXO

- vijajčna pritrnitev vodnikov 1.5-2.5mm<sup>2</sup>
- XO brez okvirja
- 2P+E francoska
- 16A 250V~, tip VE40

## SOCKET FRENCH 2P+E 16A 250V~ \_\_ XO

- screw contacts 1.5-2.5mm<sup>2</sup>
- XO without surround
- 2P+E French
- 16A 250V~, type VE40



## VTIČNICA FRANCOSKA+POKROV 2P+E 16A 250V~ \_\_ XO

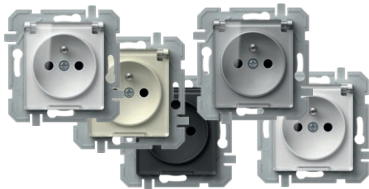

- VE41PTXO
- VE41ITXO
- VE41STXO
- VE41BTXO

- vijajčna pritrnitev vodnikov 1.5-2.5mm<sup>2</sup>
- XO brez okvirja
- 2P+E francoska+pokrov
- 16A 250V~, tip VE41

## SOCKET FRENCH+COVER 2P+E 16A 250V~ \_\_ XO

- screw contacts 1.5-2.5mm<sup>2</sup>
- XO without surround
- 2P+E French+cover
- 16A 250V~, type VE41



## VTIČNICA FRANCOSKA 2P+E 16A 250V~ BV \_\_ XO



- VE42PWXO
- VE42IWXO
- VE42ESXO
- VE42COXO
- VE42NBXO
- VE42RDXO
- VE42GRXO
- VE42ORXO

- BV brezvijajčna pritrnitev vodnikov 1.5-2.5mm<sup>2</sup>
- XO brez okvirja
- 2P+E francoska
- 16A 250V~, tip VE42

## SOCKET FRENCH 2P+E 16A 250V~ BV \_\_ XO

- BV plug-in contacts 1.5-2.5mm<sup>2</sup>
- XO without surround
- 2P+E French
- 16A 250V~, type VE42



## VTIČNICA FRANCOSKA+POKROV 2P+E 16A 250V~ BV \_\_ XO



- VE43PTXO
- VE43ITXO
- VE43STXO
- VE43BTXO

- BV brezvijajčna pritrnitev vodnikov 1.5-2.5mm<sup>2</sup>
- XO brez okvirja
- 2P+E francoska+pokrov
- 16A 250V~, tip VE43

## SOCKET FRENCH+COVER 2P+E 16A 250V~ BV \_\_ XO

- BV plug-in contacts 1.5-2.5mm<sup>2</sup>
- XO without surround
- 2P+E French+cover
- 16A 250V~, type VE43



## VTIČNICA FRANCOSKA 2P+E 16A 250V~



- VE40PW
- VE40IW
- VE40ES
- VE40CO
- VE40NB

- vijajčna pritrnitev vodnikov 1.5-2.5mm<sup>2</sup>
- 2P+E francoska
- 16A 250V~, tip VE40

## SOCKET FRENCH 2P+E 16A 250V~

- screw contacts 1.5-2.5mm<sup>2</sup>
- 2P+E French
- 16A 250V~, type VE40



## VTIČNICA FRANCOSKA+POKROV 2P+E 16A 250V~



- VE41PT
- VE41IT
- VE41BT
- VE41ST

- vijajčna pritrnitev vodnikov 1.5-2.5mm<sup>2</sup>
- 2P+E francoska+pokrov
- 16A 250V~, tip VE41

## SOCKET FRENCH+COVER 2P+E 16A 250V~

- screw contacts 1.5-2.5mm<sup>2</sup>
- 2P+E French+cover
- 16A 250V~, type VE41



## VTIČNICA FRANCOSKA 2P+E 16A 250V~ BV



- VE42PW
- VE42IW
- VE42ES
- VE42CO
- VE42NB

- BV brezvijajčna pritrnitev vodnikov 1.5-2.5mm<sup>2</sup>
- 2P+E francoska
- 16A 250V~, tip VE42

## SOCKET FRENCH 2P+E 16A 250V~ BV

- BV plug-in contacts 1.5-2.5mm<sup>2</sup>
- 2P+E French
- 16A 250V~, type VE42



## VTIČNICA FRANCOSKA+KS+POKROV 2P+E 16A 250V~ BV



- VE43PT
- VE43IT
- VE43BT
- VE43ST

- BV brezvijajčna pritrnitev vodnikov 1.5-2.5mm<sup>2</sup>
- 2P+E francoska+pokrov
- 16A 250V~, tip VE43

## SOCKET FRENCH+COVER 2P+E 16A 250V~ BV

- BV plug-in contacts 1.5-2.5mm<sup>2</sup>
- 2P+E French+cover
- 16A 250V~, type VE43



VTIČNICA SCHUKO DVOJNA 2P+E 16A 250V~



- VE16PWKS
- VE16WKS
- VE16ESKS
- VE16NBKS

- 2P+E schuko dvojna
- 16A 250V~, tip VE16
- ustreza IEC 60884-1, CEE7
- vijačna pritrditev vodnikov 1.5-2.5 mm<sup>2</sup>
- vgrajena zaščita pred dotikom kontaktov

SOCKET SCHUKO DOUBLE 2P+E 16A 250V~

- 2P+E schuko double
- 16A 250V~, type VE16
- in accordance with IEC 60884-1, CEE7
- screw contacts 1.5-2.5 mm<sup>2</sup>
- shuttered live contacts



VTIČNICA FRANCOŠKA DVOJNA 2P+E 16A 250V~



- VE46PWKS
- VE46WKS
- VE46ESKS
- VE46NBKS

- 2P+E francoska dvojna
- 16A 250V~, tip VE46
- ustreza IEC 60884-1, CEE7; NF C 61-314, ČSN 33 2318; PN-E 93201
- vijačna pritrditev vodnikov 1,5-2,5 mm<sup>2</sup>
- vgrajena zaščita pred dotikom kontaktov

SOCKET FRENCH DOUBLE 2P+E 16A 250V~

- 2P+E French double
- 16A 250V~, type VE46
- in accordance with IEC 60884-1, CEE7; NF C 61-314, ČSN 33 2318; PN-E 93201
- screw contacts 1,5-2,5 mm<sup>2</sup>
- shuttered live contacts



VTIČNICA 2P 16A 250V~



- VE30PW
- VE30IW
- VE30ES
- VE30NB

- 2P brez ozemljitvenega kontakta
- 16A 250V~
- ustreza EN 60884-1, CEE7 (list I)
- vijačna pritrditev vodnikov 1.5-2.5mm<sup>2</sup>

SOCKET 2P 16A 250V~

- 2P without earthing contact
- 16A 250V~
- in accordance with EN 60884-1, CEE7 (standard sheet I)
- screw contacts 1.5-2.5mm<sup>2</sup>

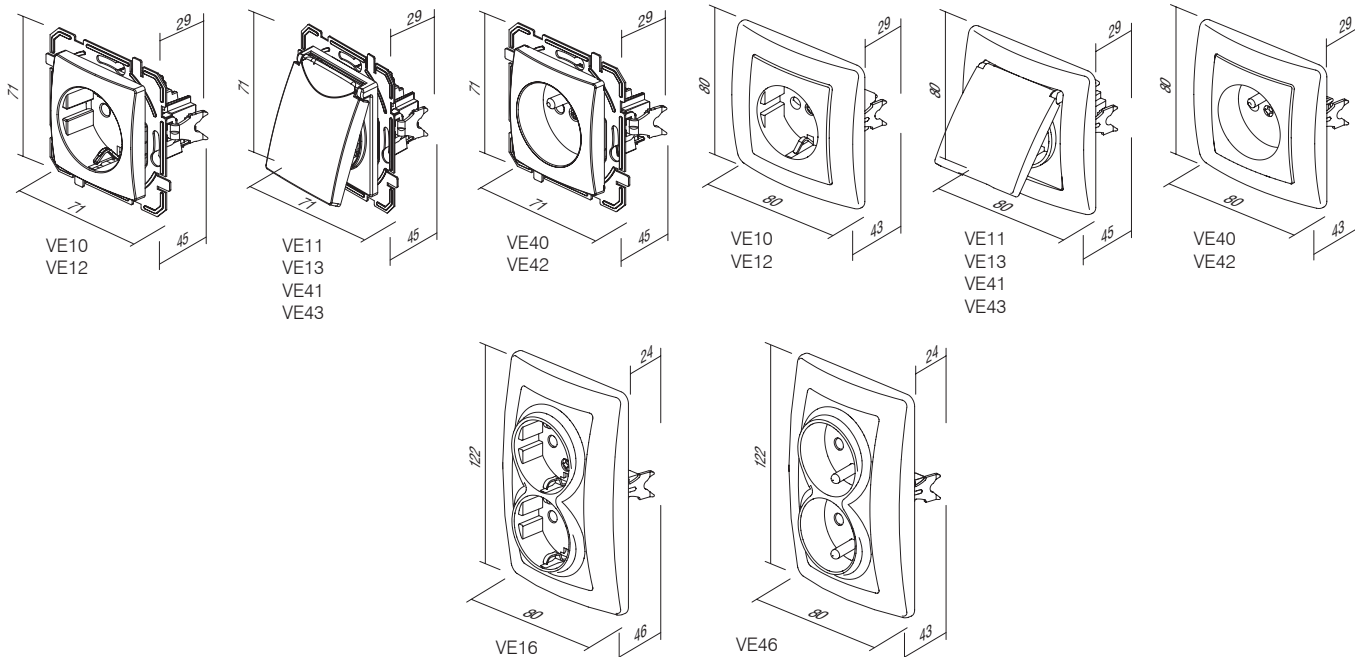



KE37

PW

tip type	naziv description	tehnični opis technical data	barva colour
KE11	VTIČNICA TV-R KONČNA SOCKET TV-R END-LINE	1dB	<input type="checkbox"/> PW bela-sijaj polar white
KE12	VTIČNICA TV-R PREHODNA SOCKET TV-R THROUGHPASS	10dB	<input type="checkbox"/> IW bež-sijaj ivory white
KE16	VTIČNICA SAT-TV-R KONČNA SOCKET SAT-TV-R END-LINE	3dB	<input type="checkbox"/> ES srebrna-mat elox silver
⋮	⋮	⋮	<input type="checkbox"/> CO beli duroplast white thermoset
⋮	⋮	⋮	<input type="checkbox"/> NB črna-sijaj night black

## VTIČNICA TV-R KONČNA 1dB



KE11

- TV-R končna
- frekvenčni pas 5÷862MHz
- dušenje: R-1,5dB, TV-1dB
- ustreza EN 50083-1
- vijajna priključitev

## SOCKET TV-R END-LINE 1dB

- TV-R end-line
- frequency range 5÷862MHz
- reduction: R-1,5dB, TV-1dB
- in accordance with EN 50083-1
- screw contacts

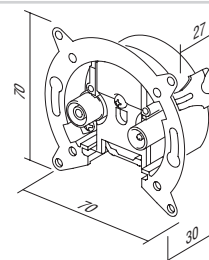
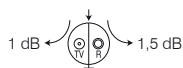

## VTIČNICA TV-R PREHODNA 10dB



KE12

- TV-R prehodna vtičnica
- frekvenčni pas 5÷862MHz
- dušenje: R-10dB, TV-10dB, prehod-2dB
- ustreza EN 50083-1
- vijajna priključitev

## SOCKET TV-R THROUGHPASS 10dB

- TV-R throughpass
- frequency range 5÷862MHz
- reduction: R-10dB, TV-10dB, through-2dB
- in accordance with EN 50083-1
- screw contacts

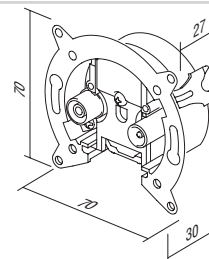
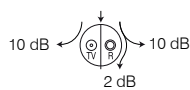

## VTIČNICA SAT-TV-R KONČNA 3dB



KE16

- SAT-TV-R končna
- frekvenčni pas 5÷2400MHz
- dušenje: R-1dB, TV-1,5dB, SAT-3dB
- vgradnja v dozo Ø60 s krepeljci ali vijaki
- ustreza EN 50083-1
- vijajna pritrditev vodnikov

## SOCKET SAT-TV-R END-LINE 3dB

- SAT-TV-R end-line
- frequency range 5÷2400MHz
- reduction: R-1dB, TV-1,5dB, SAT-3dB
- for mounting in round box Ø60 with claws or screws
- in accordance with EN 50083-1
- screw contacts

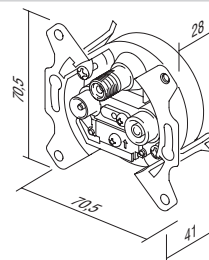
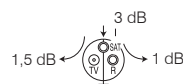

## VTIČNICA TEL KS RJ11 6/4

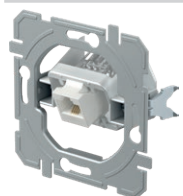

KE36

- KS keystone pritrditveni standard
- RJ11 6/4
- ustreza IEC 60603-7

## SOCKET TEL KS RJ11 6/4

- KS keystone fixing standard
- RJ11 6/4
- in accordance with IEC 60603-7

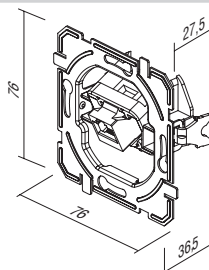

VTIČNICA CAT5e KS RJ45 8/8

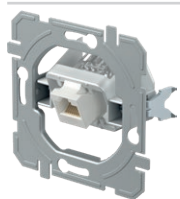

KE37

- KS keystone pritrditveni standard
- CAT5e, RJ45 8/8
- ustreza IEC 60603-7

*SOCKET CAT5e KS RJ45 8/8*  
 - KS keystone fixing standard  
 - CAT5e, RJ45 8/8  
 - in accordance with IEC 60603-7

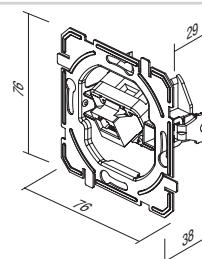

VTIČNICA CAT6s KS RJ45 8/8 SLIM

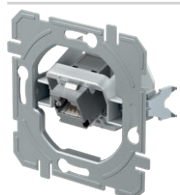

KE40

- KS keystone pritrditveni standard
- CAT6s, RJ45 8/8
- ustreza IEC 60603-7

*SOCKET CAT6s KS RJ45 8/8 SLIM*  
 - KS keystone fixing standard  
 - CAT6s, RJ45 8/8  
 - in accordance with IEC 60603-7

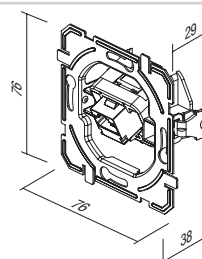

VTIČNICA TEL KS DVOJNA 2x RJ11 6/4

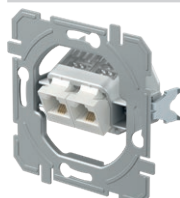

KE38

- KS keystone pritrditveni standard
- 2x RJ11 6/4
- ustreza IEC 60603-7

*SOCKET TEL KS DOUBLE 2x RJ11 6/4*  
 - KS keystone fixing standard  
 - 2x RJ11 6/4  
 - in accordance with IEC 60603-7

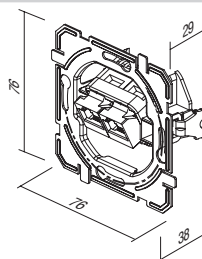

VTIČNICA CAT5e KS DVOJNA 2x RJ45 8/8



KE39

- KS keystone pritrditveni standard
- 2x CAT5e, RJ45 8/8
- ustreza IEC 60603-7

*SOCKET CAT5e KS DOUBLE 2x RJ45 8/8*  
 - KS keystone fixing standard  
 - 2x CAT5e, RJ45 8/8  
 - in accordance with IEC 60603-7

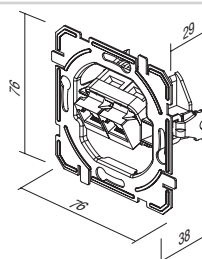

VTIČNICA CAT6s KS DVOJNA 2x RJ45 8/8 SLIM

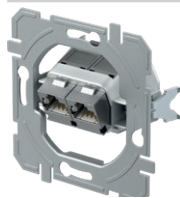

KE41

- KS keystone pritrditveni standard
- 2x CAT6s, RJ45 8/8
- ustreza IEC 60603-7

*SOCKET CAT6s KS DOUBLE 2x RJ45 8/8 SLIM*  
 - KS keystone fixing standard  
 - 2x CAT6s, RJ45 8/8  
 - in accordance with IEC 60603-7

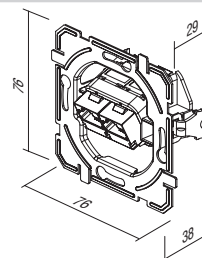

ADAPTER KS ENOJNI

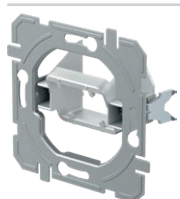

KE45

- KS keystone pritrditveni standard - enojni
- AMP, Avaya, Brandrex, FMT, Mfico, Tyco, ...
- komunikacijski modul ni vgrajen

*ADAPTER KS SINGLE*  
 - KS keystone fixing standard - single  
 - AMP, Avaya, Brandrex, FMT, Mfico, Tyco, ...  
 - communication module not included

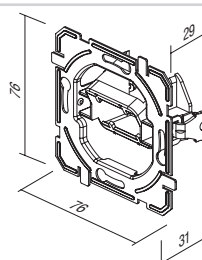

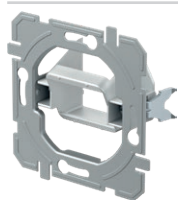

KE46

**ADAPTER KS DVOJNI**

- KS keystone pritrditveni standard - dvojni
- AMP, Tyco, ...
- komunikacijski modul ni vgrajen

**ADAPTER KS DOUBLE**

- KS keystone fixing standard - double
- AMP, Tyco, ...
- communication module not included

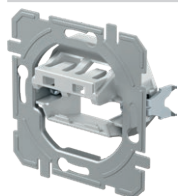
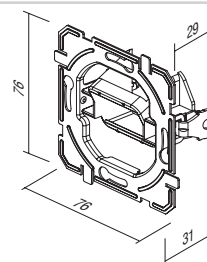

KE47

**ADAPTER PD DVOJNI**

- PD Panduit MiniCOM pritrditveni standard - dvojni
- komunikacijski modul ni vgrajen

**ADAPTER PD DOUBLE**

- PD Panduit Mini-COM fixing standard - double
- communication module not included

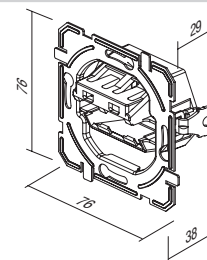

VTIČNICA TV OSNOVNA 0dB



- KE10PW
- KE10IW
- KE10ES
- KE10CO
- KE10NB

- TV osnovna
- dušenje 0dB
- konektor zadaj – F standard

SOCKET TV BASIC 0dB

- TV basic
- reduction 0dB
- back connector – F standard



VTIČNICA TV-R KONČNA 1dB



- KE11PW
- KE11IW
- KE11ES
- KE11CO
- KE11NB

- TV-R končna
- frekvenčni pas 5÷862 MHz
- dušenje: R-1.5dB, TV-1dB
- ustreza EN 50083-1
- vijajčna priključitev

SOCKET TV-R END-LINE 1dB

- TV-R end-line
- frequency range 5÷862 MHz
- reduction: R-1.5dB, TV-1dB
- in accordance with EN 50083-1
- screw contact



VTIČNICA TV-R PREHODNA 10dB



- KE12PW
- KE12IW
- KE12ES
- KE12CO
- KE12NB

- TV-R prehodna
- frekvenčni pas 5÷862 MHz
- dušenje: R-10dB, TV-10dB, prehod-2dB
- ustreza EN 50083-1
- vijajčna priključitev

SOCKET TV-R TROUGH-PASS 10dB

- TV-R troughpass
- frequency range 5÷862 MHz
- reduction: R-10dB, TV-10dB, trough-2dB
- in accordance with EN 50083-1
- screw contacts



VTIČNICA SAT-TV-R KONČNA 3dB



- KE16PW
- KE16IW
- KE16ES
- KE16CO
- KE16NB

- SAT-TV-R končna
- frekvenčni pas 5÷2400 MHz
- dušenje: R-1dB, TV-1.5dB, SAT-3dB
- ustreza EN 50083-1
- vijajčna priključitev

SOCKET SAT-TV-R END-LINE 3dB

- SAT-TV-R end-line
- frequency range 5÷2400 MHz
- reduction: R-1dB, TV-1.5dB, SAT-3dB
- in accordance with EN 50083-1
- screw contacts



VTIČNICA AVDIO 2xRCA



- KE22PW
- KE22IW
- KE22ES
- KE22CO
- KE22NB

- avdio 2xRCA
- pritrditve vodnikov s spajkanjem

SOCKET AUDIO 2xRCA

- audio 2xRCA
- soldering connection of cable



VTIČNICA AVDIO ZVOČNIŠKA



- KE23PW
- KE23IW
- KE23ES
- KE23CO
- KE23NB

- avdio 2x Ø4mm
- za priklop zvočniškega vodnika, vtiča Ø4mm ali viličastega kabel čevlja
- pritrditve vodnikov zadaj s spajkanjem

SOCKET AUDIO LOUDSPEAKERS

- audio 2x Ø4mm
- to accommodate speaker wire, banana plug Ø4mm or spades
- soldering connection of cable at the back side



VTIČNICA TEL KS RJ11 6/4

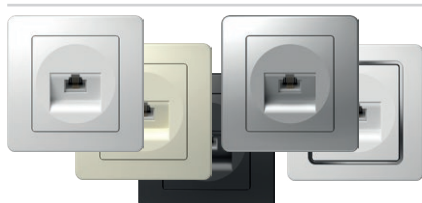

- KE36PW
- KE36IW
- KE36ES
- KE36CO
- KE36NB

- KS keystone pritrditveni standard
- RJ11 6/4
- ustreza IEC 60603-7

SOCKET TEL KS RJ11 6/4

- KS keystone fixing standard
- RJ11 6/4
- in accordance with IEC 60603-7



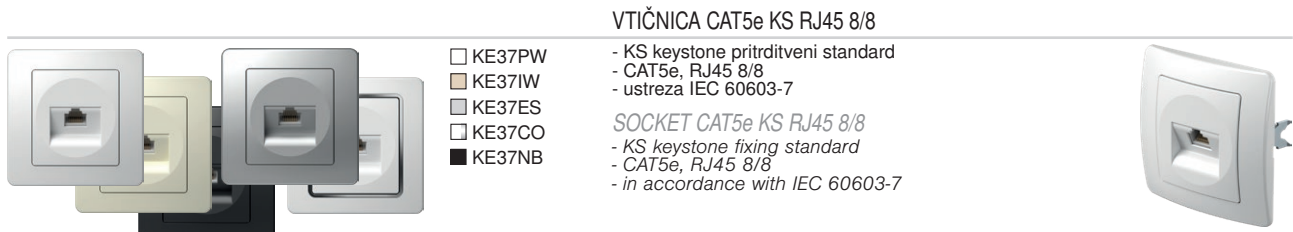

## VTIČNICA CAT5e KS RJ45 8/8

- KE37PW
- KE37IW
- KE37ES
- KE37CO
- KE37NB

- KS keystone pritrditveni standard  
- CAT5e, RJ45 8/8  
- ustreza IEC 60603-7

## SOCKET CAT5e KS RJ45 8/8

- KS keystone fixing standard  
- CAT5e, RJ45 8/8  
- in accordance with IEC 60603-7

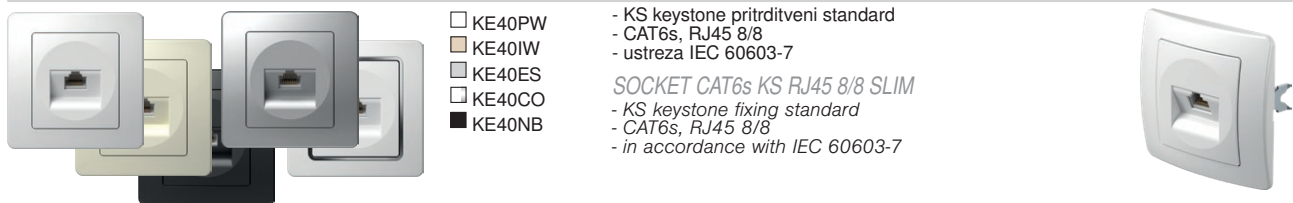

## VTIČNICA CAT6s KS RJ45 8/8 SLIM

- KE40PW
- KE40IW
- KE40ES
- KE40CO
- KE40NB

- KS keystone pritrditveni standard  
- CAT6s, RJ45 8/8  
- ustreza IEC 60603-7

## SOCKET CAT6s KS RJ45 8/8 SLIM

- KS keystone fixing standard  
- CAT6s, RJ45 8/8  
- in accordance with IEC 60603-7

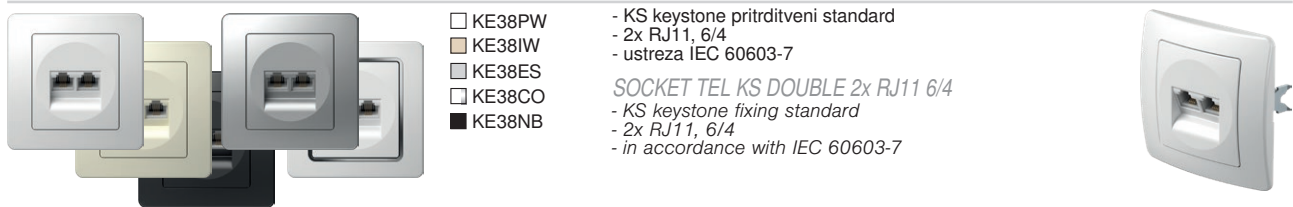

## VTIČNICA TEL KS DVOJNA 2x RJ11 6/4

- KE38PW
- KE38IW
- KE38ES
- KE38CO
- KE38NB

- KS keystone pritrditveni standard  
- 2x RJ11, 6/4  
- ustreza IEC 60603-7

## SOCKET TEL KS DOUBLE 2x RJ11 6/4

- KS keystone fixing standard  
- 2x RJ11, 6/4  
- in accordance with IEC 60603-7

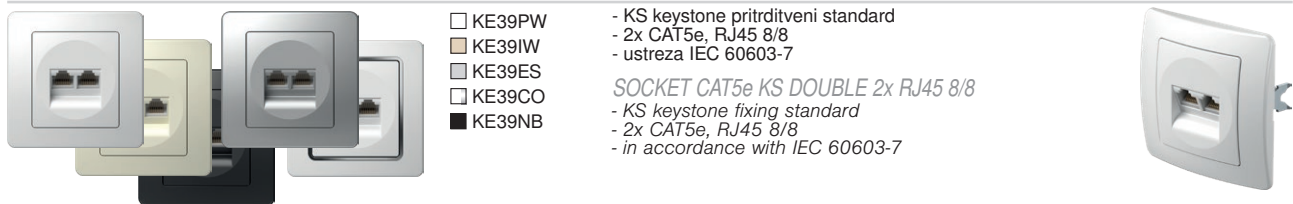

## VTIČNICA CAT5e KS DVOJNA 2x RJ45 8/8

- KE39PW
- KE39IW
- KE39ES
- KE39CO
- KE39NB

- KS keystone pritrditveni standard  
- 2x CAT5e, RJ45 8/8  
- ustreza IEC 60603-7

## SOCKET CAT5e KS DOUBLE 2x RJ45 8/8

- KS keystone fixing standard  
- 2x CAT5e, RJ45 8/8  
- in accordance with IEC 60603-7

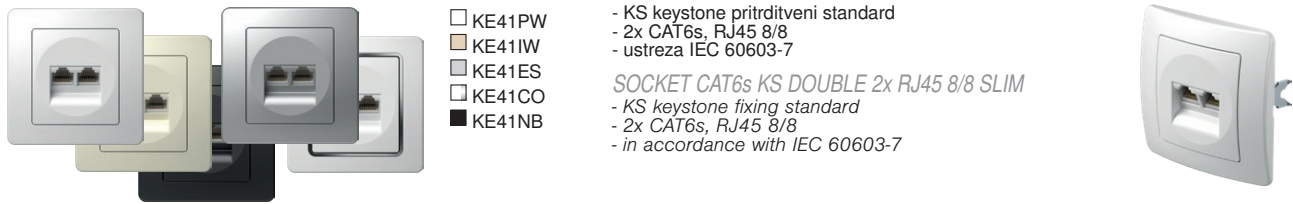

## VTIČNICA CAT6s KS DVOJNA 2x RJ45 8/8 SLIM

- KE41PW
- KE41IW
- KE41ES
- KE41CO
- KE41NB

- KS keystone pritrditveni standard  
- 2x CAT6s, RJ45 8/8  
- ustreza IEC 60603-7

## SOCKET CAT6s KS DOUBLE 2x RJ45 8/8 SLIM

- KS keystone fixing standard  
- 2x CAT6s, RJ45 8/8  
- in accordance with IEC 60603-7



## VTIČNICA TEL LT RJ11 6/4

- KE35PW
- KE35IW
- KE35ES
- KE35CO
- KE35NB

- TEL LT vijak  
- vijačna pritrditvev vodnikov  
- RJ11 6/4  
- ustreza IEC 60603-7

## SOCKET TEL LT RJ11 6/4

- TEL LT screw  
- screw contacts  
- RJ11 6/4  
- in accordance with IEC 60603-7

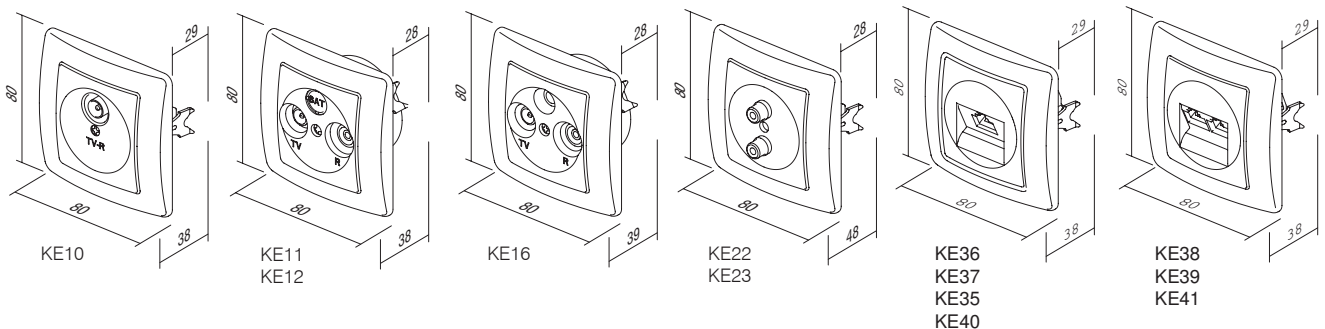

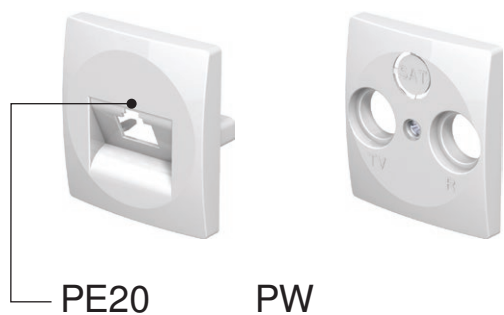

tip type	naziv description	tehnični opis technical data	barva colour
PE10	POKROV TV-R COVER TV-R	2P/3P	<input type="checkbox"/> PW bela-sijaj polar white
PE20	POKROV KS ENOJNI COVER KS SINGLE		<input type="checkbox"/> IW bež-sijaj ivory white
PE21	POKROV KS DVOJNI COVER KS DOUBLE		<input type="checkbox"/> ES srebrna-mat elox silver
⋮	⋮	⋮	<input type="checkbox"/> CO beli duroplast white thermoset
			<input type="checkbox"/> NB črna-sijaj night black

POKROV TV-R 2P/3P



- PE10PW
- PE10IW
- PE10ES
- PE10CO
- PE10NB

- TV-R pokrov, 2P ali 3P z vijakom

COVER TV-R 2P/3P

- TV-R cover, 2P or 3P with screw



POKROV KS ENOJNI

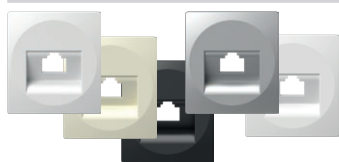

- PE20PW
- PE20IW
- PE20ES
- PE20CO
- PE20NB

- KS pokrov enojni

COVER KS SINGLE

- KS cover single



POKROV KS DVOJNI

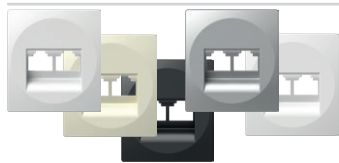

- PE21PW
- PE21IW
- PE21ES
- PE21NB

- KS pokrov dvojni

COVER KS DOUBLE

- KS cover double



POKROV TAE/TDO



- PE30PW
- PE30IW
- PE30ES
- PE30NB

- TAE ali TDO pokrov z vijakom

COVER TAE/TDO

- TAE or TDO cover with screw

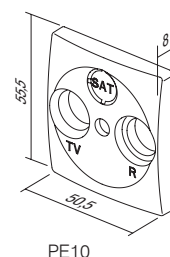
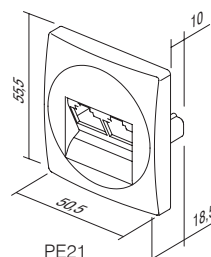
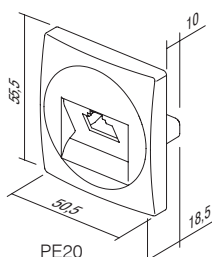
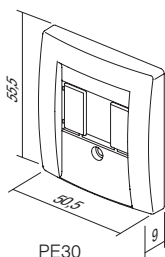





EE15

PW

tip type	naziv description	tehnični opis technical data	barva colour
EE15	ZATEMNILNIK ROTACIJSKI MEN DIMMER ROTATIVE 2WAY	RL 400W	<input type="checkbox"/> PW bela-sijaj polar white
EE16	ZATEMNILNIK ROTACIJSKI MEN DIMMER ROTATIVE 2WAY	RLC 400W	<input type="checkbox"/> IW bež-sijaj ivory white
EE19	ZATEMNILNIK ROTACIJSKI MEN DIMMER ROTATIVE 2WAY	LED 100W	<input type="checkbox"/> ES srebrna-mat elox silver
⋮	⋮	⋮	<input type="checkbox"/> CO beli duroplast white thermoset
⋮	⋮	⋮	<input type="checkbox"/> NB črna-sijaj night black

## ZATEMNILNIK ROTACIJSKI MEN RL 400W



EE15



- rotacijski z menjalnim stikalom
- breme RL, 40W - 400W
- možna vezava z menjalnim stikalom
- vezava večih zatemnilnikov ni dovoljena
- ustreza EN 60669-1 in EN 60669-2-1
- brezvijačna pritrnitev vodnikov 1.5mm<sup>2</sup>
- napajanje 230V~ 50Hz
- premer nastavka gumba Ø6mm
- zamenljiva varovalka vključena

## DIMMER ROTATIVE 2WAY RL 400W

- rotation control with 2-way switch
- load RL, 40W - 400W
- 2-way switch combination is possible
- more dimmers combination is not allowed
- in accordance with EN 60669-1 and EN 60669-2-1
- plug-in contacts 1.5mm<sup>2</sup>
- supply 230V~ 50Hz
- button inner diameter Ø6mm
- replaceable fuse included

## ZATEMNILNIK ROTACIJSKI MEN RLC 400W



EE16



- rotacijski z menjalnim stikalom
- breme RLC, 20W - 400W
- možna vezava z menjalnim stikalom
- vezava večih zatemnilnikov ni dovoljena
- ustreza EN 60669-1 in EN 60669-2-1
- brezvijačna pritrnitev vodnikov 1.5mm<sup>2</sup>
- napajanje 230V~ 50Hz
- premer nastavka gumba Ø6mm
- elektronska varovalka

## DIMMER ROTATIVE 2WAY RLC 400W

- rotation control with 2-way switch
- load RLC, 20W - 400W
- 2-way switch combination is possible
- more dimmers combination is not allowed
- in accordance with EN 60669-1 and EN 60669-2-1
- plug-in contacts 1.5mm<sup>2</sup>
- supply 230V~ 50Hz
- button inner diameter Ø6mm
- electronic fuse

## ZATEMNILNIK ROTACIJSKI MEN LED 100W

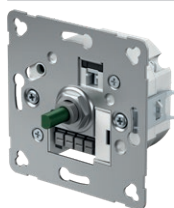

EE19



- rotacijski z menjalnim stikalom
- breme: LED, 0-100W (max. 10 LED sijalk)  
GLS, 10-250W
- možna vezava z menjalnim stikalom
- vezava več zatemnilnikov ni dovoljena
- ustreza EN 60669-1 in EN 60669-2-1
- brezvijačna pritrnitev vodnikov 1,5 mm<sup>2</sup>
- napajanje 230V~ 50 Hz
- zamenljiva varovalka vključena
- premer nastavka gumba Ø6mm

*DIMMER ROTATIVE 2WAY LED 100W*

- rotation control with 2-way switch
- load: LED, 0-100W (max. 10 LEDs)  
GLS, 10-250W
- 2-way switch combination is possible
- more dimmers combination is not allowed
- in accordance with EN 60669-1 and EN 60669-2-1
- plug-in contacts 1.5mm<sup>2</sup>
- supply 230V~ 50Hz
- replaceable fuse included
- button inner diameter Ø6mm

## IR STIKALO 5A 230V~

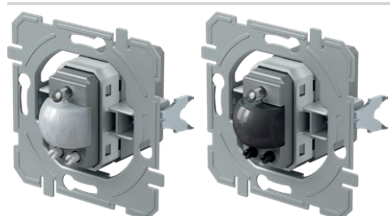

- EE32A1
- EE32A2



- IR infrardeče stikalo
- napajanje: 230V~ ±10 % 50Hz
- rele: 5A / 250V~ (zero crossing)
- stopnja varnosti: IP40
- presek žic pri stičniku: 0,75 - 2,5 mm<sup>2</sup>
- kot zaznavanja: do 110° pri 20°C
- območje zaznavanja: približno 8 m pri 20°C
- nastavljivost časovnega trajanja: od približno 5 s do 12 min
- nastavljivost osvetlitve: od približno 5 do 200 LUX
- temperatura delovanja: od 0°C do +40°C
- ni primeren za vgradnjo v doze, globine 45 mm
- samo za notranjo uporabo

*IR SWITCH 5A 230V~*

- IR infrared switch
- supply voltage: 230V~ ±10 % 50Hz
- relay: 5A / 250V~ (zero crossing)
- protection rating: IP40
- cross-section of wires at the contact terminal: 0.75 - 2.5 mm<sup>2</sup>
- detection angle: up to 110° at 20°C
- detection area: approx. 8 m at 20°C
- adjustability of duration: from approx. 5 s to 12 min
- adjustability of brightness: from approx. 5 to 200 LUX
- operating temperature: from 0°C to +40°C
- not suitable for installation in 45 mm deep boxes
- only for indoor usage



- EE15PW
- EE15IW
- EE15ES
- EE15CO
- EE15NB



#### ZATEMNILNIK ROTACIJSKI MEN RL 400W

- rotacijski z menjalnim stikalom
- breme RL, 40W - 400W
- možna vezava z menjalnim stikalom
- vezava večih zatemnilnikov ni dovoljena
- ustreza EN 60669-1 in EN 60669-2-1
- brezvijačna pritrditev vodnikov 1.5mm<sup>2</sup>
- napajanje 230V~ 50Hz
- zamenljiva varovalka vključena

#### DIMMER ROTATIVE 2WAY RL 400W

- rotation control with 2-way switch
- load RL, 40W - 400W
- 2-way switch combination is possible
- more dimmers combination is not allowed
- in accordance with EN 60669-1 and EN 60669-2-1
- plug-in contacts 1.5mm<sup>2</sup>
- supply 230V~ 50Hz
- replaceable fuse included



- EE16PW
- EE16IW
- EE16ES
- EE16CO
- EE16NB



#### ZATEMNILNIK ROTACIJSKI MEN RLC 400W

- rotacijski z menjalnim stikalom
- breme RLC, 20W - 400W
- možna vezava z menjalnim stikalom
- vezava večih zatemnilnikov ni dovoljena
- ustreza EN 60669-1 in EN 60669-2-1
- brezvijačna pritrditev vodnikov 1.5mm<sup>2</sup>
- napajanje 230V~ 50Hz
- elektronska varovalka

#### DIMMER ROTATIVE 2WAY RLC 400W

- rotation control with 2-way switch
- load RLC, 20W - 400W
- 2-way switch combination is possible
- more dimmers combination is not allowed
- in accordance with EN 60669-1 and EN 60669-2-1
- plug-in contacts 1.5mm<sup>2</sup>
- supply 230V~ 50Hz
- electronic fuse



- EE19PW
- EE19IW
- EE19ES
- EE19CO
- EE19NB



#### ZATEMNILNIK ROTACIJSKI MEN LED 100W

- rotacijski z menjalnim stikalom
- breme: LED, 0-100W (max. 10 LED sijalk) GLS, 10-250W
- možna vezava z menjalnim stikalom
- vezava več zatemnilnikov ni dovoljena
- ustreza EN 60669-1 in EN 60669-2-1
- brezvijačna pritrditev vodnikov 1,5 mm<sup>2</sup>
- napajanje 230V~ 50 Hz
- zamenljiva varovalka vključena

#### DIMMER ROTATIVE 2WAY LED 100W

- rotation control with 2-way switch
- load: LED, 0-100W (max. 10 LEDs) GLS, 10-250W
- 2-way switch combination is possible
- more dimmers combination is not allowed
- in accordance with EN 60669-1 and EN 60669-2-1
- plug-in contacts 1.5mm<sup>2</sup>
- supply 230V~ 50Hz
- replaceable fuse included



- EE32PW
- EE32IW
- EE32ES
- EE32CO
- EE32NB



#### IR STIKALO 5A 230V~

- IR infrardeče stikalo
- napajanje: 230V~ ±10 % 50Hz
- rele: 5A / 250V~ (zero crossing)
- stopnja varnosti: IP40
- presek žic pri stičniku: 0,75 - 2,5 mm<sup>2</sup>
- kot zaznavanja: do 110° pri 20°C
- območje zaznavanja: približno 8 m pri 20°C
- nastavitljivost časovnega trajanja: od približno 5 s do 12 min
- nastavitljivost osvetlitve: od približno 5 do 200 LUX
- temperatura delovanja: od 0°C do +40°C
- ni primeren za vgradnjo v doze, globine 45 mm
- samo za notranjo uporabo

#### IR SWITCH 5A 230V~

- IR infrared switch
- supply voltage: 230V~ ±10 % 50Hz
- relay: 5A / 250V~ (zero crossing)
- protection rating: IP40
- cross-section of wires at the contact terminal: 0.75 - 2.5 mm<sup>2</sup>
- detection angle: up to 110° at 20°C
- detection area: approx. 8 m at 20°C
- adjustability of duration: from approx. 5 s to 12 min
- adjustability of brightness: from approx. 5 to 200 LUX
- operating temperature: from 0°C to +40°C
- not suitable for installation in 45 mm deep boxes
- only for indoor usage





- EE69PW
- EE69IW
- EE69NB
- EE69ES

#### POLNILNIK USB PD 20W

- USB napajalnik z dovajanjem moči do 20W.
- za polnjenje elektronskih naprav prek standardnega USB priključka (kompatibilno tudi z Apple napravami)
- napajanje: 100-230 V~ 50/60 Hz
- poraba med delovanjem: 420 mA pri 100 V~/220 mA pri 230 V~
- poraba v mirovanju: <100 mW pri 230 V~
- izhodna moč: 20W Max

Izhod:

- USB tip C: 5.0 VDC 3.0A; 9.0 VDC 2.2 A; 12.0 VDC 1.67 A (PD 20W)
- USB tip A: 5.0 VDC 3.0A; 9.0 VDC 2.0 A; 12.0 VDC 1.5 A (QC 18W)
- USB A+C: 5 VDC 3A
- tip konektorja: 1 x USB A; 1 x USB C
- povprečna učinkovitost v aktivnem stanju: 86 %
- učinkovitost pri minimalnem bremenu (10%): 81%
- temperatura delovanja: 0 °C/+ 45 °C (notranja uporaba)
- IP zaščitni razred: IP20, samo za notranjo uporabo
- varnostni razred naprave II
- prenapetostna zaščita (EN 60364-4-44): razred III
- vijajna pritrditev vodnikov max. 2.5 mm<sup>2</sup>
- naprava z odmikom kontaktov min. 3 mm
- ni primeren za vgradnjo v doze globine 45 mm in ohišja CUBO IP20

Ustreza:

Direktivam: BT, EMC, RoHS, ErP

Standardim: EN IEC 62368-1, EN 55032, EN55035, EN IEC 61000-3-2, EN 61000-3-3, EN 50563, EN IEC 63000

Dodatnim regulativam: (EU) n. 2019/1782 REACh, n. 1907/2006 – art.33. Produkt lahko vsebuje sledi svinca.



#### USB POWER SUPPLY UNIT PD 20W

- 20 W USB power delivery power supply unit
- for charging of electronic devices via a standard USB port (also compatible with Apple devices)

- power supply: 100-230V~ 50/60Hz
- power consumption: 420mA at 100V~/220mA at 230V~
- standby power consumption: <100mW at 230V~
- Output power: 20 W Max

- Output:

- USB tip C: 5.0 VDC 3.0A; 9.0 VDC 2.2 A; 12.0 VDC 1.67 A (PD 20W)
- USB tip A: 5.0 VDC 3.0A; 9.0 VDC 2.0 A; 12.0 VDC 1.5 A (QC 18W)
- USB A+C: 5 VDC 3A

- connector type: 1x USB A; 1x USB C

- average efficiency in active mode: 86%

- efficiency with low load (10%): 81%

- operating temperature: 0°C/+45°C (indoor use)

- IP protection class: IP20, indoor use only

- class device II

- overvoltage category (EN 60364-4-44): Class III

- screw contacts: max. 2.5 mm<sup>2</sup>

- device with a contact gap of at least 3mm

Conformity:

Directive: BT, EMC, RoHS, ErP

Standards: EN IEC 62368-1, EN 55032, EN55035, EN IEC 61000-3-2, EN 61000-3-3, EN 50563, EN IEC 63000

External power supplies regulation: (EU) n. 2019/1782 REACh, n. 1907/2006 – art.33. The product may contain traces of lead.

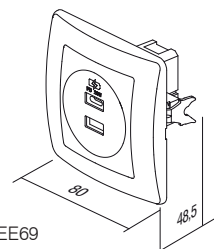

EE69

EE15, EE16, EE19

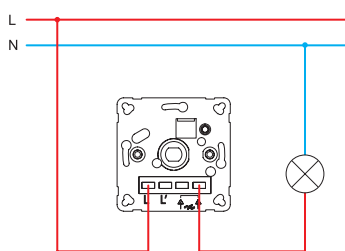

EE15, EE16, EE19

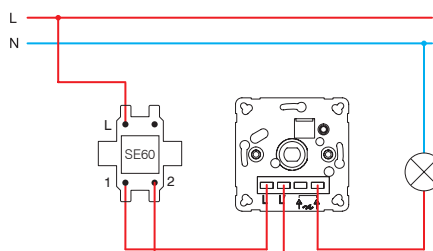

EE15, EE16, EE19

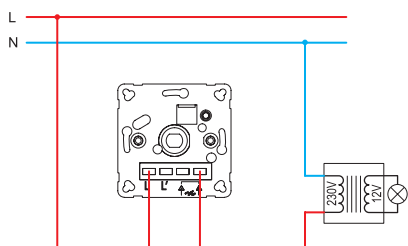

EE15, EE16, EE19

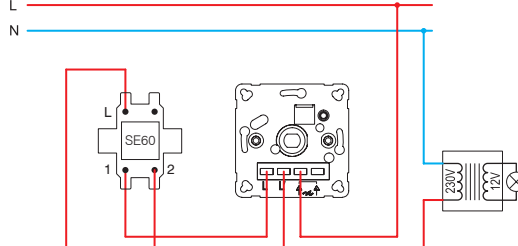

EE16, EE19

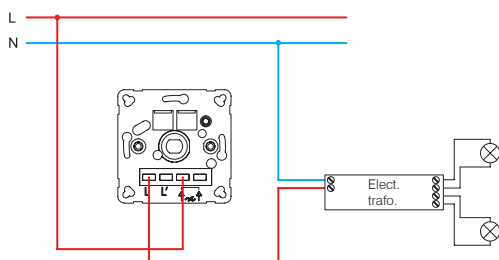

EE16, EE19

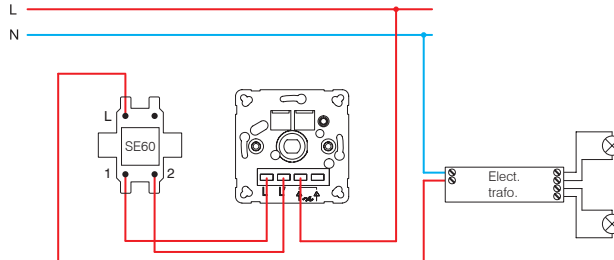

EE15 (40÷400W)

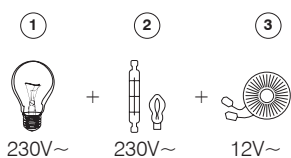

1 - žarnica z žarilno nitko /  
incandescent lamp

2 - halogenska žarnica /  
halogen lamp

EE16 (20÷400W)

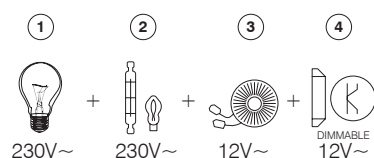

3 - klasični transformator /  
classical transformer

4 - zatemnilni elektronski transformator /  
dimnable electronic transformer

EE19 (GLS 10÷250W ; LED 0÷100W)

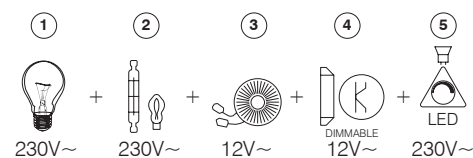

5 - zatemnilna LED sijalka /  
dimnable LED lamp

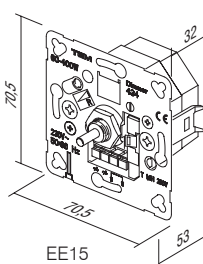
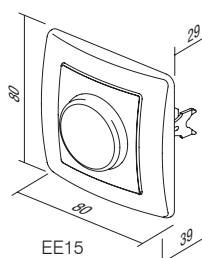
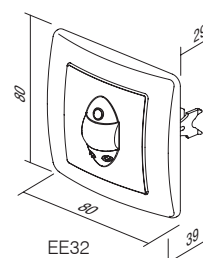
EE15  
EE16  
EE19EE15  
EE16  
EE19

EE32



PE41

PW

tip type	naziv description	barva colour
PE41	POKROV ZATEMNILNO STIKALO COVER DIMMER	<input type="checkbox"/> PW bela-sijaj <i>polar white</i> <input type="checkbox"/> IW bež-sijaj <i>ivory white</i> <input type="checkbox"/> ES srebrna-mat <i>elox silver</i> <input type="checkbox"/> CO beli duroplast <i>white thermoset</i> <input type="checkbox"/> NB črna-sijaj <i>night black</i>

POKROV ZATEMNILNO STIKALO Ø6



- PE41PW
- PE41IW
- PE41NB
- PE41ES
- PE41CO

- pokrov zatemnilno stikalo Ø6mm  
- za EE15, EE16, EE19

COVER DIMMER Ø6  
- cover dimmer Ø6mm  
- for EE15, EE16, EE19



POKROV IR STIKALO



- PE32PW
- PE32IW
- PE32NB
- PE32ES

- pokrov IR stikalo

COVER IR SWITCH  
- cover IR switch

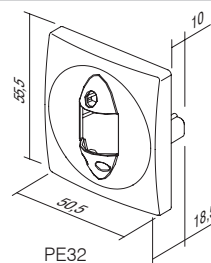

PE32

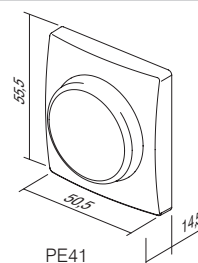

PE41

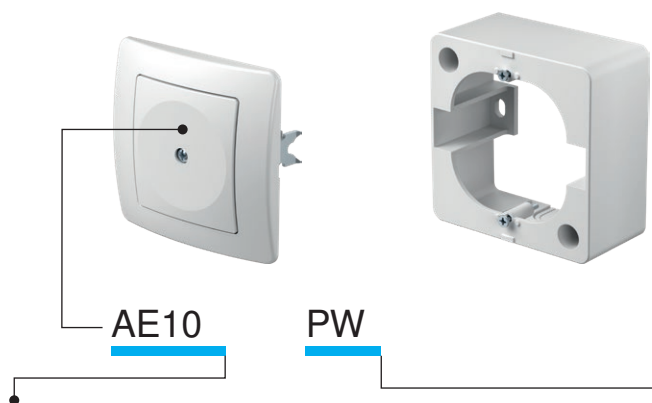

tip type	naziv description	barva colour
AE10	POLNILO BLANK	<input type="checkbox"/> PW bela-sijaj polar white
AE20	PRIKLJUČEK PETPOLNI STALNI 3P+N+E 5X4mm <sup>2</sup> CONNECTION BOX 3P+N+E 5X4mm <sup>2</sup>	<input type="checkbox"/> IW bež-sijaj ivory white
AE30	OHIŠJE NO 1 SURFACE MOUNT BOX	<input type="checkbox"/> ES srebrna-mat elox silver
⋮	⋮	<input type="checkbox"/> CO beli duroplast white thermoset
⋮	⋮	<input type="checkbox"/> NB črna-sijaj night black

## POLNILO



- AE10PW
- AE10IW
- AE10NB
- AE10ES
- AE10CO

- za pokrivanje praznih odprtín

BLANK

- for filling up empty spaces

PRIKLJUČEK PETPOLNI STALNI 3P+N+E 5x4mm<sup>2</sup>

- AE20PW
- AE20IW

- 3P+N+E stalni priključek

- 16A 400V~

- ustreza VDE 0601-1:2000

- vijajčna pritrditev vodnikov 1.5-4mm<sup>2</sup>CONNECTION BOX 5POLE 3P+N+E 5x4mm<sup>2</sup>

- 3P+N+E connection box

- 16A 400V~

- in accordance with VDE 0606-1:2000

- screw contacts 1.5-4mm<sup>2</sup>

## OHIŠJE NADOMETNO 1

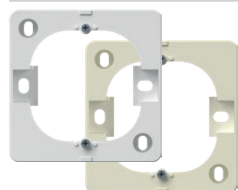

- AE30PW
- AE30IW

- nadometno ohišje

SURFACE MOUNT BOX 1

- surface mounting box



## OHIŠJE NADOMETNO ZA DVOJNO VTIČNICO

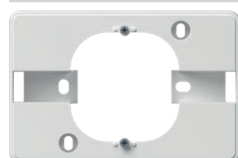

- AE31PW

- nadometno ohišje

SURFACE MOUNT BOX FOR DOUBLE SOCKET

- surface mounting box



### STENSKI ŠČITNIK

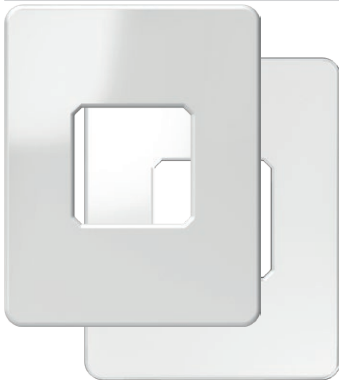

- AE50PW
- AE50TS

- ščitnik stene okoli stikala ali vtičnice

#### WALL PROTECTION

- protects surface around socket or switch

### OTROŠKA ZAŠČITA KS



- AE51PW
- AE51IW

- KS otroška zaščita pred dotikom kontaktov

#### CHILD PROTECTION KS

- KS additional child protection insert - shuttered live contacts

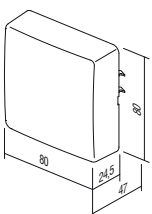

AE20

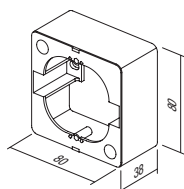

AE30

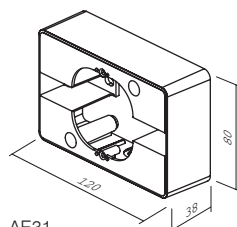

AE31

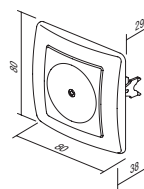

AE10



## S U R R O U N D S O E

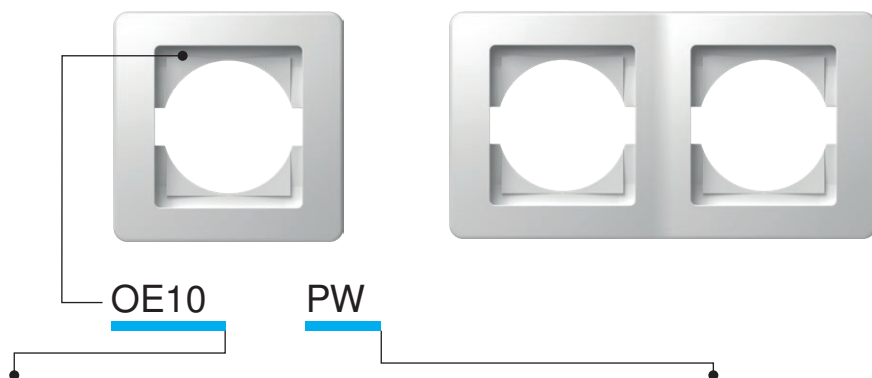

tip type	naziv description	barva colour
OE10	OKVIR EKONOMIK 1 SURROUND EKONOMIK 1	<input type="checkbox"/> PW bela-sijaj polar white
OE20	OKVIR EKONOMIK 2 HORIZONTALNI SURROUND EKONOMIK 2 HORIZONTAL	<input type="checkbox"/> IW bež-sijaj ivory white
OE30	OKVIR EKONOMIK 3 HORIZONTALNI SURROUND EKONOMIK 3 HORIZONTAL	<input type="checkbox"/> ES srebrna-mat elox silver
⋮	⋮	<input type="checkbox"/> CO beli duroplast white thermoset
⋮	⋮	<input type="checkbox"/> NB črna-sijaj night black

## OKVIR EKONOMIK 1



- OE10PW
- OE10IW
- OE10ES
- OE10CO
- OE10NB

- dekorativni enojni okvir  
- ustreza EN 60669-1

*SURROUND EKONOMIK 1*  
- decorative surround 1-gang  
- in accordance with EN 60669-1

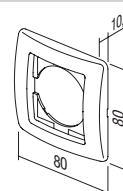

## OKVIR EKONOMIK 2 HORIZONTALNI



- OE20PW
- OE20IW
- OE20ES
- OE20CO
- OE20NB

- dekorativni dvojni horizontalni okvir  
- ustreza EN 60669-1

*SURROUND EKONOMIK 2 HORIZONTAL*  
- decorative surround 2-gang horizontal  
- in accordance with EN 60669-1

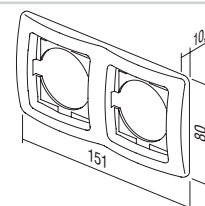

## OKVIR EKONOMIK 2 VERTIKALNI



- OE21PW
- OE21IW
- OE21ES
- OE21CO
- OE21NB

- dekorativni dvojni vertikalni okvir  
- ustreza EN 60669-1

*SURROUND EKONOMIK 2 VERTICAL*  
- decorative surround 2-gang vertical  
- in accordance with EN 60669-1

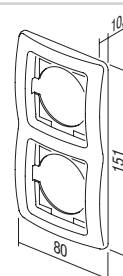

## OKVIR EKONOMIK 3 HORIZONTALNI



- OE30PW
- OE30IW
- OE30ES
- OE30CO
- OE30NB

- dekorativni trojni horizontalni okvir  
- ustreza EN 60669-1

*SURROUND EKONOMIK 3 HORIZONTAL*  
- decorative surround 3-gang horizontal  
- in accordance with EN 60669-1

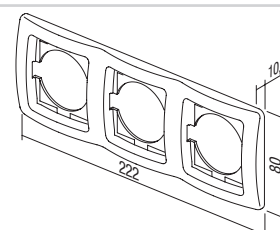



- OE31PW
- OE31IW
- OE31ES
- OE31CO
- OE31NB

**OKVIR EKONOMIK 3 VERTIKALNI**

- dekorativni trojni vertikalni okvir  
- ustreza EN 60669-1

*SURROUND EKONOMIK 3 VERTICAL*

- decorative surround 3-gang vertical  
- in accordance with EN 60669-1

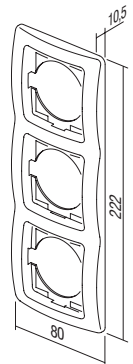

- OE40PW
- OE40IW
- OE40ES
- OE40NB

**OKVIR EKONOMIK 4 HORIZONTALNI**

- dekorativni četvorni horizontalni okvir  
- ustreza EN 60669-1

*SURROUND EKONOMIK 4 HORIZONTAL*

- decorative surround 4-gang horizontal  
- in accordance with EN 60669-1

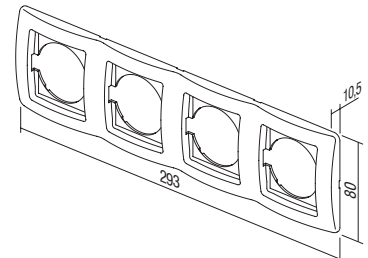

- OE41PW
- OE41IW
- OE41ES
- OE41NB

**OKVIR EKONOMIK 4 VERTIKALNI**

- dekorativni četvorni vertikalni okvir  
- ustreza EN 60669-1

*SURROUND EKONOMIK 4 VERTICAL*

- decorative surround 4-gang vertical  
- in accordance with EN 60669-1

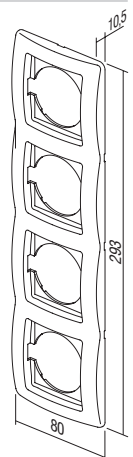

- OE50PW
- OE50IW
- OE50ES
- OE50NB

**OKVIR EKONOMIK 5 HORIZONTALNI**

- dekorativni 5-mestni horizontalni okvir  
- ustreza EN 60669-1

*SURROUND EKONOMIK 5 HORIZONTAL*

- decorative surround 5-gang horizontal  
- in accordance with EN 60669-1

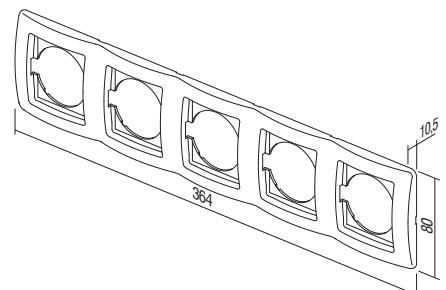

DEKORATIVNI OKVIRČKI COLOR /  
 COLOR DECORATIVE FRAMES



OE90GR ZELENA /  
 GREEN

OE90BL MODRA /  
 BLUE

OE90VO VIJOLA /  
 VIOLET

OE90PI ROZA /  
 PINK

OE90RD RDEČA /  
 RED

OE90YL RUMENA /  
 YELLOW

OE90WH BELA /  
 WHITE

OE90GY SIVA /  
 GREY

OE90BK ČRNA /  
 BLACK

OE90MB MET. MODRA /  
 MET. BLUE

OE90BZ BRON /  
 BRONZE

OE90CR SREBRNA /  
 SILVER

OE90GO ZLATA /  
 GOLD





**fontana**



**TEM**



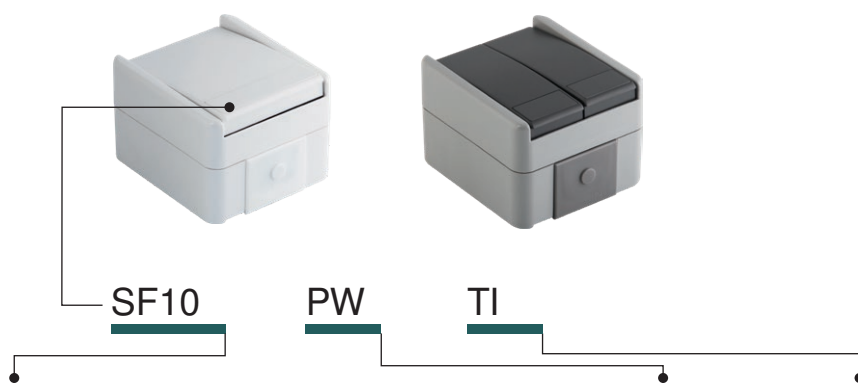

tip type	naziv description	tehnični opis technical data	barva colour	opsijski opis 1 optional data 1
SF10	STIKALO ENOPOLNO SWITCH 1WAY	IP44 10AX 250V~	<input type="checkbox"/> PW bela-mat white-mat	TI tlivka+indikator neon lamp+indication
SF11	TIPKALO ENOPOLNO PUSH BUTTON 1WAY	IP44 10A 250V~	<input type="checkbox"/> GY siva-mat grey-mat	
SF20	STIKALO DVOPOLNO SWITCH 2POLE	IP44 10AX 250V~		
:	:	:		
:	:	:		

STIKALO ENOPOLNO IP44 10AX 250V~



- SF10PW
- SF10GY

- 10AX 250V~, tip SF10  
- ustreza EN 60669-1  
- brezvijačna pritrditev vodnikov 1.5-2.5mm<sup>2</sup>

SWITCH 1WAY IP44 10AX 250V~  
- 10AX 250V~, type SF10  
- in accordance with EN 60669-1  
- plug-in contacts 1.5-2.5mm<sup>2</sup>



STIKALO ENOPOLNO IP44 10AX 250V~ \_\_ TI



- SF10PWTI
- SF10GYTI

- TI indikator+tlivka  
- 10AX 250V~, tip SF10  
- ustreza EN 60669-1  
- brezvijačna pritrditev vodnikov 1.5-2.5mm<sup>2</sup>

SWITCH 1WAY IP44 10AX 250V~ \_\_ TI  
- TI indikator+neon lamp  
- 10AX 250V~, type SF10  
- in accordance with EN 60669-1  
- plug-in contacts 1.5-2.5mm<sup>2</sup>



TIPKALO ENOPOLNO IP44 10A 250V~ \_\_ TI



- SF11PWTI
- SF11GYTI

- TI indikator+tlivka  
- 10A 250V~, tip SF11  
- ustreza EN 60669-1  
- brezvijačna pritrditev vodnikov 1.5-2.5mm<sup>2</sup>

PUSH BUTTON 1WAY IP44 10A 250V~ \_\_ TI  
- TI indikator+neon lamp  
- 10A 250V~, type SF11  
- in accordance with EN 60669-1  
- plug-in contacts 1.5-2.5mm<sup>2</sup>



STIKALO DVOPOLNO IP44 10AX 250V~















- SF20PW
- SF20GY

- 10AX 250V~, tip SF20  
- ustreza EN 60669-1  
- brezvijačna pritrditev vodnikov 1.5-2.5mm<sup>2</sup>

SWITCH 2POLE IP44 10AX 250V~  
- 10AX 250V~, type SF20  
- in accordance with EN 60669-1  
- plug-in contacts 1.5-2.5mm<sup>2</sup>



	<ul style="list-style-type: none"> <li><input type="checkbox"/> SF50PW</li> <li><input checked="" type="checkbox"/> SF50GY</li> </ul>	<p><b>STIKALO SERIJSKO IP44 10AX 250V~</b></p> <ul style="list-style-type: none"> <li>- 10AX 250V~, tip SF50</li> <li>- ustreza EN 60669-1</li> <li>- brezvijačna pritrditev vodnikov 1.5-2.5mm<sup>2</sup></li> </ul> <p><i>SWITCH 2GANG-1WAY IP44 10AX 250V~</i></p> <ul style="list-style-type: none"> <li>- 10AX 250V~, type SF50</li> <li>- in accordance with EN 60669-1</li> <li>- plug-in contacts 1.5-2.5mm<sup>2</sup></li> </ul>	
	<ul style="list-style-type: none"> <li><input type="checkbox"/> SF51PW</li> <li><input checked="" type="checkbox"/> SF51GY</li> </ul>	<p><b>TIPKALO SERIJSKO IP44 10A 250V~</b></p> <ul style="list-style-type: none"> <li>- 10A 250V~, tip SF51</li> <li>- ustreza EN 60669-1</li> <li>- brezvijačna pritrditev vodnikov 1.5-2.5mm<sup>2</sup></li> </ul> <p><i>PUSH BUTTON 2GANG-1WAY IP44 10A 250V~</i></p> <ul style="list-style-type: none"> <li>- 10A 250V~, type SF51</li> <li>- in accordance with EN 60669-1</li> <li>- plug-in contacts 1.5-2.5mm<sup>2</sup></li> </ul>	
	<ul style="list-style-type: none"> <li><input type="checkbox"/> SF60PW</li> <li><input checked="" type="checkbox"/> SF60GY</li> </ul>	<p><b>STIKALO MENJALNO IP44 10AX 250V~</b></p> <ul style="list-style-type: none"> <li>- 10AX 250V~, tip SF60</li> <li>- ustreza EN 60669-1</li> <li>- brezvijačna pritrditev vodnikov 1.5-2.5mm<sup>2</sup></li> </ul> <p><i>SWITCH 2WAY IP44 10AX 250V~</i></p> <ul style="list-style-type: none"> <li>- 10AX 250V~, type SF60</li> <li>- in accordance with EN 60669-1</li> <li>- plug-in contacts 1.5-2.5mm<sup>2</sup></li> </ul>	
	<ul style="list-style-type: none"> <li><input type="checkbox"/> SF60PWTI</li> <li><input checked="" type="checkbox"/> SF60GYTI</li> </ul>	<p><b>STIKALO MENJALNO IP44 10AX 250V~ __ TI</b></p> <ul style="list-style-type: none"> <li>- TI indikator+tlivka</li> <li>- 10AX 250V~, tip SF60</li> <li>- ustreza EN 60669-1</li> <li>- brezvijačna pritrditev vodnikov 1.5-2.5mm<sup>2</sup></li> </ul> <p><i>SWITCH 2WAY IP44 10AX 250V~ __ TI</i></p> <ul style="list-style-type: none"> <li>- TI indikator+neon lamp</li> <li>- 10AX 250V~, type SF60</li> <li>- in accordance with EN 60669-1</li> <li>- plug-in contacts 1.5-2.5mm<sup>2</sup></li> </ul>	
	<ul style="list-style-type: none"> <li><input type="checkbox"/> SF63PW</li> <li><input checked="" type="checkbox"/> SF63GY</li> </ul>	<p><b>STIKALO DVOJNO MENJALNO IP44 10AX 250V~</b></p> <ul style="list-style-type: none"> <li>- 10AX 250V~, tip SF63</li> <li>- ustreza EN 60669-1</li> <li>- brezvijačna pritrditev vodnikov 1.5-2.5mm<sup>2</sup></li> </ul> <p><i>SWITCH 2WAY DOUBLE IP44 10AX 250V~</i></p> <ul style="list-style-type: none"> <li>- 10AX 250V~, type SF63</li> <li>- in accordance with EN 60669-1</li> <li>- plug-in contacts 1.5-2.5mm<sup>2</sup></li> </ul>	
	<ul style="list-style-type: none"> <li><input type="checkbox"/> SF70PW</li> <li><input checked="" type="checkbox"/> SF70GY</li> </ul>	<p><b>STIKALO KRIŽNO IP44 10AX 250V~</b></p> <ul style="list-style-type: none"> <li>- 10AX 250V~, tip SF70</li> <li>- ustreza EN 60669-1</li> <li>- brezvijačna pritrditev vodnikov 1.5-2.5mm<sup>2</sup></li> </ul> <p><i>SWITCH INTERMEDIATE IP44 10AX 250V~</i></p> <ul style="list-style-type: none"> <li>- 10AX 250V~, type SF70</li> <li>- in accordance with EN 60669-1</li> <li>- plug-in contacts 1.5-2.5mm<sup>2</sup></li> </ul>	

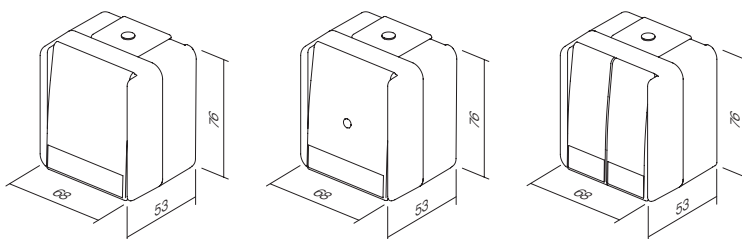



VF10

PW

tip type	naziv description	tehnični opis technical data	barva colour
VF10	VTIČNICA SCHUKO+POKROV SOCKET SCHUKO+COVER	IP44 2P+E 16A 250V~	<input type="checkbox"/> PW bela-mat white-mat  <input type="checkbox"/> GY siva-mat grey-mat



- VF10PW
- VF10GY

VTIČNICA SCHUKO+POKROV IP44 2P+E 16A 250V~

- vijajna pritrditev vodnikov 1.5-2.5mm<sup>2</sup>
- 2P+E schuko+pokrov
- 16A 250V~, tip VF10
- ustreza EN 60884-1, CEE7

SOCKET SCHUKO+COVER IP44 2P+E 16A 250V~

- screw contacts 1.5-2.5mm<sup>2</sup>
- 2P+E schuko+cover
- 16A 250V~, type VF10
- in accordance with EN 60884-1, CEE7



- VF12PW
- VF12GY

VTIČNICA SCHUKO+POKROV IP44 2P+E 16A 250V~ BV

- BV brezvičajna pritrditev vodnikov 1.5-2.5mm<sup>2</sup>
- 2P+E schuko+pokrov
- 16A 250V~, tip VF12
- ustreza EN 60884-1, CEE7

SOCKET SCHUKO+COVER IP44 2P+E 16A 250V~ BV

- BV plug-in contacts 1.5-2.5mm<sup>2</sup>
- 2P+E schuko+cover
- 16A 250V~, type VF12
- in accordance with EN 60884-1, CEE7

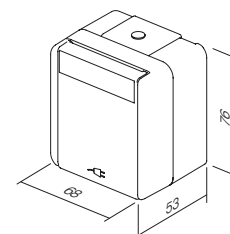

VF10  
VF12



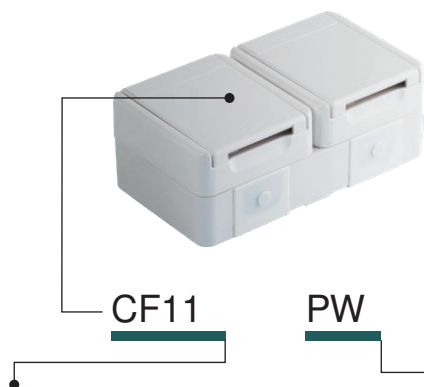

tip type	naziv description	tehnični opis technical data	barva colour
CF10	SET VTIČNICA SCHUKO DVOJNA HORIZ SOCKET SET SCHUKO DOUBLE HORIZ	2x 2P+E 16A 250V~ IP44	<input type="checkbox"/> PW bela-mat white-mat
CF11	SET VTIČNICA SCHUKO DVOJNA VERT SOCKET SET SCHUKO DOUBLE VERT	2x 2P+E 16A 250V~ IP44	<input checked="" type="checkbox"/> GY siva-mat grey-mat
CF12	SET VTIČNICA SCH + STIKALO MEN HORIZ SOCKET SCH+SWITCH 2WAY HORIZ	16A + 10A 250V~ IP44	
⋮	⋮	⋮	
⋮	⋮	⋮	

#### SET VTIČNICA SCHUKO DVOJNI HORIZONTALNI IP44 2x 2P+E 16A 250V~



- CF10PW  
 CF10GY

- vijačna pritrditev vodnikov 1.5-2.5mm<sup>2</sup>
- 2x 2P+E schuko+pokrov horizontalni
- 16A 250V~, tip CF10
- ustreza EN 60884-1, CEE7

SOCKET SET SCHUKO DOUBLE  
HORIZONTAL IP44 2x 2P+E 16A 250V~  
- screw contacts 1.5-2.5mm<sup>2</sup>  
- 2x 2P+E schuko+cover horizontal  
- 16A 250V~, type CF10  
- in accordance with EN 60884-1, CEE7



#### SET VTIČNICA SCHUKO DVOJNI VERTIKALNI IP44 2x 2P+E 16A 250V~



- CF11PW  
 CF11GY

- vijačna pritrditev vodnikov 1.5-2.5mm<sup>2</sup>
- 2x 2P+E schuko+pokrov vertikalni
- 16A 250V~, tip CF11
- ustreza EN 60884-1, CEE7

SOCKET SET SCHUKO DOUBLE VERTICAL  
IP44 2x 2P+E 16A 250V~  
- screw contacts 1.5-2.5mm<sup>2</sup>  
- 2x 2P+E schuko+cover vertical  
- 16A 250V~, type CF11  
- in accordance with EN 60884-1, CEE7



#### SET VTIČNICA SCH + STIKALO MEN HORIZONTALNI IP44 16A + 10AX 250V~



- CF12PW  
 CF12GY

- vijačna (vtičnica), brezvijačna (stikalo) pritrditev vodnikov 1.5-2.5mm<sup>2</sup>
- 2P+E schuko+pokrov + stikalo menjalno horizontalni
- 16A + 10AX 250V~, tip CF12
- ustreza EN 60884-1, CEE7, EN 60669-1

SOCKET SCH+SWITCH SET 2WAY  
HORIZONTAL IP44 16A + 10AX 250V~  
- screw (socket), plug-in (switch)  
contacts 1.5-2.5mm<sup>2</sup>  
- 2P+E schuko+cover + switch 2-way horizontal  
- 16A + 10AX 250V~, type CF12  
- in accordance with EN 60884-1, CEE7, EN 60669-1



SET VTIČNICA SCH + STIKALO MEN VERTIKALNI IP44 16A + 10AX 250V~



- CF13PW
- CF13GY

- vijačna (vtičnica), brezvijačna (stikalo) pritrđitev vodnikov 1.5-2.5mm<sup>2</sup>
- 2P+E schuko+pokrov + stikalo menjalno vertikalni
- 16A + 10AX 250V~, tip CF13
- ustreza EN 60884-1, CEE7, EN 60669-1

SOCKET SCH+SWITCH 2WAY SET VERTICAL IP44 16A + 10AX 250V~

- screw (socket), plug-in (switch) contacts 1.5-2.5mm<sup>2</sup>
- 2P+E schuko+cover + switch 2-way vertical
- 16A + 10AX 250V~, type CF13
- in accordance with EN 60884-1, CEE7, EN 60669-1



SET VTIČNICA SCHUKO DVOJNI HORIZONTALNI IP44 2x 2P+E 16A 250V~ BV



- CF14PW
- CF14GY

- BV brezvijačna pritrđitev vodnikov 1.5-2.5mm<sup>2</sup>
- 2x 2P+E schuko+pokrov horizontalna
- 16A 250V~, tip CF14
- ustreza EN 60884-1, CEE7

SOCKET SET SCHUKO DOUBLE HORIZONTAL IP44 2x 2P+E 16A 250V~ BV

- BV plug-in contacts 1.5-2.5mm<sup>2</sup>
- 2x 2P+E schuko+cover horizontal
- 16A 250V~, type CF14
- in accordance with EN 60884-1, CEE7



SET VTIČNICA SCHUKO DVOJNI VERTIKALNI IP44 2x 2P+E 16A 250V~ BV



- CF15PW
- CF15GY

- BV brezvijačna pritrđitev vodnikov 1.5-2.5mm<sup>2</sup>
- 2x 2P+E schuko+pokrov vertikalna
- 16A 250V~, tip CF15
- ustreza EN 60884-1, CEE7

SOCKET SET SCHUKO DOUBLE VERTICAL IP44 2x 2P+E 16A 250V~ BV

- BV plug-in contacts 1.5-2.5mm<sup>2</sup>
- 2x 2P+E schuko+cover vertical
- 16A 250V~, type CF15
- in accordance with EN 60884-1, CEE7



SET VTIČNICA SCH + STIKALO MEN HORIZONTALNI IP44 16A + 10AX 250V~ BV



- CF16PW
- CF16GY

- BV brezvijačna pritrđitev vodnikov 1.5-2.5mm<sup>2</sup>
- 2P+E schuko+pokrov + stikalo menjalno horizontalni
- 16A + 10AX 250V~, tip CF16
- ustreza EN 60884-1, CEE7, EN 60669-1

SOCKET+SWITCH SET SCH+2WAY HORIZONTAL IP44 16A + 10AX 250V~ BV

- BV plug-in contacts 1.5-2.5mm<sup>2</sup>
- 2P+E schuko+cover + switch 2-way horizontal
- 16A + 10AX 250V~, type CF16
- in accordance with EN 60884-1, CEE7, EN 60669-1



SET VTIČNICA SCH+STIKALO MEN VERTIKALNI IP44 16A + 10AX 250V~ BV



- CF17PW
- CF17GY

- BV brezvijačna pritrđitev vodnikov 1.5-2.5mm<sup>2</sup>
- 2P+E schuko+pokrov + stikalo menjalno vertikalni
- 16A + 10AX 250V~, tip CF17
- ustreza EN 60884-1, CEE7, EN 60669-1

SOCKET SCH+SWITCH 2WAY SET VERTICAL IP44 16A + 10AX 250V~ BV

- BV plug-in contacts 1.5-2.5mm<sup>2</sup>
- 2P+E schuko+cover + switch 2-way vertical
- 16A + 10AX 250V~, type CF17
- in accordance with EN 60884-1, CEE7, EN 60669-1



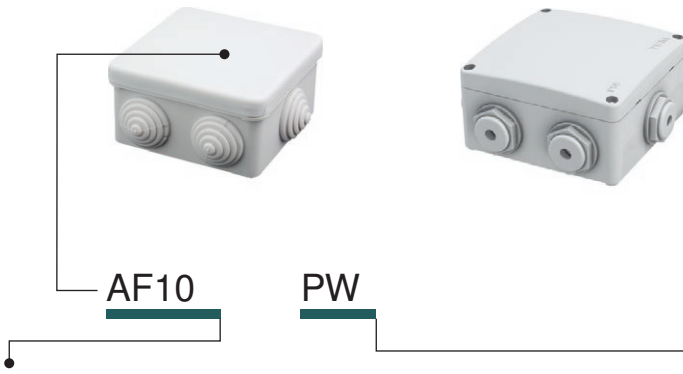

tip type	naziv description	tehnični opis technical data	barva colour
AF10	RAZVODNICA DISTRIBUTION BOX	IP44 RN01	<input type="checkbox"/> PW bela-mat white-mat
AF20	RAZVODNICA DISTRIBUTION BOX	IP55 ND01	<input type="checkbox"/> GY siva-mat grey-mat

**RAZVODNICA IP44 RN01**



- AF10PW
- AF10GY

- nadometna razvodnica IP44
- 16A 400V~
- ustreza IEC/EN 60670-1, IEC/EN 60670-22

**DISTRIBUTION BOX IP44 RN01**

- surface mounting distribution box IP44
- 16A 400V~
- in accordance with IEC/EN 60670-1, IEC/EN 60670-22

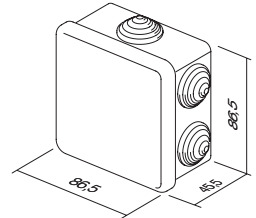

**RAZVODNICA IP55 ND01**



- AF20PW
- AF20GY

- nadometna razvodnica IP55
- uvodnice priložene
- ustreza IEC/EN 60670-1, IEC/EN 60670-22

**DISTRIBUTION BOX IP55 ND01**

- surface mounting connection box IP55
- glands included
- in accordance with IEC/EN 60670-1, IEC/EN 60670-22

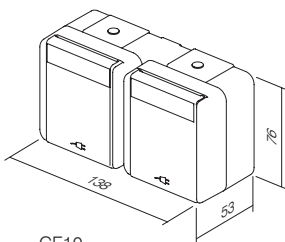
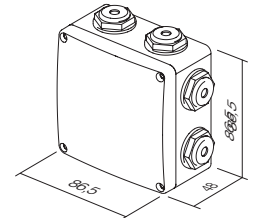

CF10  
CF14

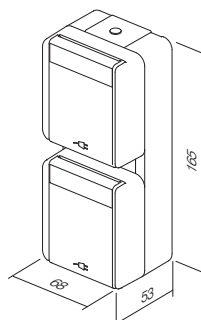

CF11  
CF15

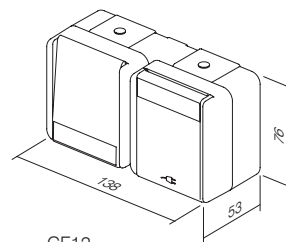

CF12  
CF16

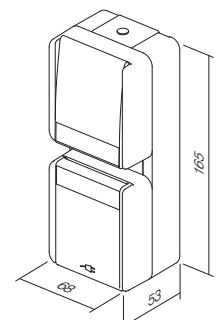

CF13  
CF17

šifra	opis izdelka	stran	šifra	opis izdelka	stran
<b>STIKALA SM</b>			<b>KOMUNIKACIJE KM</b>		
SM10	STIKALO ENOPOLNO 16AX 250V- 1M	44	KM10--	VTIČNICA TV OSNOVNA 0dB 1M	60
SM11	TIPKALO ENOPOLNO 16A 250V- 1M	44	KM20--	VTIČNICA TV OSNOVNA 0dB 2M	60
SM12	STIKALO ENOPOLNO 20A 250V- 1M	44	KM11--	VTIČNICA TV KONČNA 1dB 1M	60
SM20	STIKALO DVOPOLNO 16AX 250V- 1M	44	KM12--	VTIČNICA TV PREHODNA 10dB 1M	61
SM40	STIKALO ŽALUZIJSKO 1-0-2 16AX 250V- 1M	45	KM15--	VTIČNICA SAT OSNOVNA 0dB 1M	61
SM41	TIPKALO ŽALUZIJSKO 1-0-2 16A 250V- 1M	45	KM24--	VTIČNICA SAT OSNOVNA 0dB 2M	61
SM60	STIKALO MENJALNO 16AX 250V- 1M	45	KM16--	VTIČNICA SAT KONČNA 1dB 1M	61
SM61	TIPKALO MENJALNO 16A 250V- 1M	45	KM19--	VTIČNICA R OSNOVNA 0dB 1M	62
SM70	STIKALO KRIŽNO 16AX 250V- 1M	45	KM29--	VTIČNICA R OSNOVNA 0dB 2M	62
SM10--	STIKALO ENOPOLNO 16AX 250V- 1M	46	KM17--	VTIČNICA SAT-TV KONČNA 1dB 1M	62
SM10--IN	STIKALO ENOPOLNO 16AX 250V- 1M IN	46	KM22--	VTIČNICA AVDIO 2xRCA 1M	63
SM11--	TIPKALO ENOPOLNO 16A 250V- 1M	46	KM23--	VTIČNICA AVDIO ZVOČNIŠKA 1M	63
SM11--IN01	TIPKALO ENOPOLNO 16A 250V- 1M IN 01	46	KM26--	VTIČNICA AVDIO ZVOČNIŠKA 2M	63
SM11--IN02	TIPKALO ENOPOLNO 16A 250V- 1M IN 02	47	KM30--	VTIČNICA TEL LT RJ11 6/4 1M	64
SM20--NT03	STIKALO DVOPOLNO 16AX 250V- 1M NT 03	47	KM31--	VTIČNICA TEL BT SEC 6/6 1M	64
SM20--IN	STIKALO DVOPOLNO 16AX 250V- 1M IN	47	KM36--	VTIČNICA TEL KS RJ11 6/4 1M	64
SM40--NT10	STIKALO ŽALUZIJSKO 1-0-2 16AX 250V- 1M NT 10	47	KM37--	VTIČNICA CAT5e KS RJ45 8/8 1M	64
SM41--NT10	TIPKALO ŽALUZIJSKO 1-0-2 16A 250V- 1M NT 10	47	KM35--	ADAPTER KS 1M	64
SM60--	STIKALO MENJALNO 16AX 250V- 1M	47	KM38--	ADAPTER KS S PRAŠNO ZAŠČITO 1M	64
SM61--	TIPKALO MENJALNO 16A 250V- 1M	48	KM39--	VTIČNICA CAT6 SCH KS RJ45 8/8 1M	65
SM62--CD	TIPKALO MENJALNO Z VRVICO 16A 250V- 1M CD	48	KM50--	ADAPTER KS UNIVERZALNI 1M	65
SM70--	STIKALO KRIŽNO 16AX 250V- 1M	48	KM40--	ADAPTER PD 1M	65
<b>TIPKE TM</b>			KM43--	ADAPTER PD S PRAŠNO ZAŠČITO 1M	65
TM11--	TIPKA 1M	49	KM46--	ADAPTER R&M 1M	66
TM11--IN	TIPKA 1M IN	49	KM52--	ADAPTER R&M CAT6A 1M	66
TM12--	TIPKA 2M	49	KM47--	ADAPTER R&M S PRAŠNO ZAŠČITO 1M	66
TM12--IN	TIPKA 2M IN	49	KM53--	ADAPTER R&M CAT6A S PRAŠNO ZAŠČITO 1M	66
TM13--IL	TIPKA 2M Z NAPISNO PLOŠČICO	50	KM45--	ADAPTER LK 1M	67
TM15--	TIPKA 1M DVOPOLNA	50	KA26	ADAPTER NEXANS/SCRACK 2M	67
TM21--	POLNILO 1M	50	KM48--	ADAPTER AT&T SYSTIMAX S PRAŠNO ZAŠČITO 1M	67
TM22--	POLNILO 2M	50	KM51--	VTIČNICA USB TIP A 1M	67
TM31--	UVODNICA 1M	50	<b>KOMUNIKACIJSKI PRIBOR KA</b>		
<b>SIGNALIZACIJA IA</b>			KA10	KONEKTOR KS CAT3 RJ11 6/4	68
IA100R	TLIVKA 230V- 0,34W	52	KA11	KONEKTOR KS CAT5e RJ45 8/8	68
IA20--	LED SIGNALIZACIJA 230V AC/DC 0,4W	52	KA12	KONEKTOR KS CAT5eS RJ45 8/8	68
IA21--	LED SIGNALIZACIJA 24V AC/DC 0,2W	52	KA15	KONEKTOR KS CAT6 SCHRACK RJ45 8/8	69
IA22--	LED SIGNALIZACIJA 12V AC/DC 0,10W	52	KA16	KONEKTOR KS CAT6S SCHRACK RJ45 8/8	69
IA50	RC VEZJE 250V	52	KA17	KONEKTOR KS CAT6a SCHRACK RJ45 8/8	69
<b>STIKALA SP</b>			KA18	KONEKTOR SLIM KS CAT6S SCHRACK RJ45 8/8	69
SP10	STIKALO ENOPOLNO 16AX 250V- 1M	54	KA27	KONEKTOR KS HDMI	69
SP11	TIPKALO ENOPOLNO 16A 250V- 1M	54	KA28	KABEL KS HDMI	69
SP12	STIKALO ENOPOLNO 20A 250V- 1M	54			
SP20	STIKALO DVOPOLNO 16AX 250V- 1M	54			
SP40	STIKALO ŽALUZIJSKO 1-0-2 16AX 250V- 1M	55			
SP41	TIPKALO ŽALUZIJSKO 1-0-2 16A 250V- 1M	55			
SP60	STIKALO MENJALNO 16AX 250V- 1M	55			
SP61	TIPKALO MENJALNO 16A 250V- 1M	55			
SP70	STIKALO KRIŽNO 16AX 250V- 1M	55			
<b>VTIČNICE VM</b>					
VM10--	VTIČNICA SCHUKO+KS 2P+E 16A 250V- 2M	56			
VM11--	VTIČNICA SCHUKO+KS+POKROV 2P+E 16A 250V- 2M	56			
VM20--	VTIČNICA EURO+KS 2P 10A 250V- 1M	57			
VM40--	VTIČNICA FRANCOSKA+KS 2P+E 16A 250V- 2M	57			
VM41--	VTIČNICA FRANCOSKA+KS+POKROV 2P+E 16A 250V- 2M	57			
VM30--	VTIČNICA ITALIJANSKA P17/11+KS 2P+E 16A 250V- 1M	57			
VM31--	VTIČNICA SCHUKO/ITA P17/11+KS 2P+E 16A 250V- 2M	57			
VM32--	VTIČNICA SCHUKO/ITA P30+KS 2P+E 16A 250V- 2M	58			
VM33--	VTIČNICA ITALIJANSKA P11+KS 2P+E 10A 250V- 1M	58			
VM21--	VTIČNICA EURO/AMERIŠKA+KS 2P 16A 250V- 1M	58			
VM52--	VTIČNICA BRITANSKA BS 1363+KS 2P+E 13A 250V- 2M	58			
VM55--	VTIČNICA VEČSTANDARDNA+KS 2P+E 13A 250V- 2M	58			
VM80	PRENAPETOSTNA ZAŠČITA MPE MINI 275V/50Hz	58			

šifra	opis izdelka	stran	šifra	opis izdelka	stran
<b>ELEKTRONIKA EM</b>			<b>OKVIRJI LINE OL</b>		
EM12--	ZATEMNILNIK ROTACIJSKI/MENJALNI RL 300W 1M	70	OL10--	OKVIR LINE 1/2M	106
EM13--	ZATEMNILNIK ROTACIJSKI/MENJALNI LED 60W 1M	71	OL20--	OKVIR LINE 2M	106
EM14--	ZATEMNILNIK ROTACIJSKI/MENJALNI LED 180W 1M	71	OL24--	OKVIR LINE 2x2M	106
EM15--	ZATEMNILNIK ROTACIJSKI R 250W 1M	72	OL26--	OKVIR LINE 3x2M	106
EM23	ZATEMNILNIK VGRADNI R (250 W), (RC,RL 200VA)	72	OL28--	OKVIR LINE 4x2M	106
EM16--	1-10 V ZATEMNILNIK ROTACIJSKI MENJALNI	73	OL29--	OKVIR LINE 5x2M	106
EM17	KRMILNI modul MZC za EM18	74	OL13--	OKVIR LINE 1/3M	107
EM18	ZATEMNILNIK VGRADNI LED 250W	74	OL30--	OKVIR LINE 3M	107
EM19	ZATEMNILNIK VGRADNI DC LED 96W	75	OL40--	OKVIR LINE 4M	107
EM25--	STIKALO/ZATEMNILNIK UNIVEZALNI RLC 0-300W 2M	76	OL70--	OKVIR LINE 7M	107
EM26--	TIPKALO UPRAVLJALNO 2M	78	OL71--	OKVIR LINE 2x7M	107
EM25PPOL20	SET STIKALO / ZATEMNILNIK UNIVERZALNI RLC 0-300W 2M PP OL20	78	OL23--	OKVIR LINE 2/3M	107
EM27	FILTER OMREŽNIH MOTENJ	79	<b>OKVIRJI SOFT OS</b>		
EM28--	OHIŠJE TALILNE VAROVALKE 230 VAC, 50Hz 1M	79	OS10--	OKVIR SOFT 1/2M	110
EM29	VAROVALKA	79	OS20--	OKVIR SOFT 2M	110
EM31--	IR STIKALO 5A 230V- 1M	79	OS24--	OKVIR SOFT 2x2M	110
EM32--	IR STIKALO 5A 230V- 2M	80	OS26--	OKVIR SOFT 3x2M	110
EM33--	SENZORSKO STIKALO 5A 230V- 1M	80	OS28--	OKVIR SOFT 4x2M	110
EM38--	TERMOSTAT OGREVANJE 5(2)A 230V- 2M	82	OS13--	OKVIR SOFT 1/3M	111
EM39--	TERMOSTAT OGREVANJE/HLAJENJE 3(1,5)A 230V- 2M	83	OS30--	OKVIR SOFT 3M	111
NM39	NOSILEC Z VIJAKI ZA TERMOSTATE FANTINI COSMI 3M	84	OS40--	OKVIR SOFT 4M	111
EM46--	KARTIČNO STIKALO 16 A / 230 VAC, 50 Hz 3M	84	OS70--	OKVIR SOFT 7M	111
EM44--	KARTIČNO STIKALO ZA VARČEVANJE Z ENERGIJO RF HF 13,56MGz 3M	85	OS71	OKVIR SOFT 2x7M	111
EM47	KARTICA ISO	85	OS72--	OKVIR SOFT 2x7M	111
EM49	RELE ENOTA ZA KARTIČNO STIKALO 2x16A 250V	86	OS23--	OKVIR SOFT 2/3M	111
EM45	RAZDELILNIK SPL-1	86	<b>OKVIRJI PURE OP</b>		
EM60--	VTIČNICA ZA BRIVNIK 230V~/120V- 3M	87	OP20--	OKVIR PURE 2M	116
EM57	LED ZASILNA SVETILKA 230V- 50 Hz 0,5W, NIMH 2h 2M	87	OP24--	OKVIR PURE 2x2M	116
EM55	LED ZASILNA SVETILKA 250V- 0,9W, NiCd 3h 7M	88	OP26--	OKVIR PURE 3x2M	116
EM69--	POLNILNIK USB PD 20W	89	OP28--	OKVIR PURE 4x2M	116
EM50--	LED AMBIENTALNA ENOTA ENOBARVNA	90	OP13--	OKVIR PURE 1/3M	117
EM51--	SVETILKA LED DVOBARVNA 250V- 2x0,4W 2M	90	OP30--	OKVIR PURE 3M	117
EM52--	SVETILKA LED 3D DVOBARVNA 250V- 2x0,4W 2M	90	OP40--	OKVIR PURE 4M	117
EM71--	STIKALO NA PRSTNI ODTIS BIOPASS 2M	91	OP70--	OKVIR PURE 7M	117
EM82--	VEČOPRAVILNO ČASOVNO STIKALO EM82	92	OP23--	OKVIR PURE 2/3M	117
EM90--	BRENČAČ 8VA 230V- 1M	94	<b>OKVIRJI EDGE OG</b>		
EM91--	BRENČAČ 8VA 12V 1M	94	OG10--P	OKVIR EDGE 1/2M	120
EM92--	ZVONEC 8VA 230V- 1M	94	OG20--P	OKVIR EDGE 2M	120
EM93--	ZVONEC 8VA 12V 1M	95	OG13--P	OKVIR EDGE 1/3M	121
EM94--	ELEKTRONSKI ZVONEC 230V- 6mA rms 1M	95	OG30--P	OKVIR EDGE 3M	121
EM95--	REGULATOR GLASNOSTI ZA 100V AVDIO LINIJO 35W 2M	96	OG40--P	OKVIR EDGE 4M	121
EM96--	REGULATOR GLASNOSTI NIZKOOHMSKI 4-8 Ω 35W 2M	96	OG70--P	OKVIR EDGE 7M	121
<b>SETI CM</b>			OG23--P	OKVIR EDGE 2/3M	121
CM10--	SET VTIČNIC 2x SCHUKO 2P+E 16A 250V- 4M	97	<b>OKVIRJI EDGE OG</b>		
CM11--	SET VTIČNIC 3x SCHUKO 2P+E 16A 250V- 7M	97	OG10--M	OKVIR EDGE 1/2M	123
CM15	SET VEZNIKOV BARVNI 3x1,5mm <sup>2</sup> 1M	98	OG20--M	OKVIR EDGE 2M	123
CM16	SET VEZNIKOV BARVNI 3x2,5mm <sup>2</sup> 2M	98	OG24--M	OKVIR EDGE 2x2M	123
CM17	SET VIJAKOV 3,5x20	98	OG26--M	OKVIR EDGE 3x2M	123
CM18	SET VIJAKOV 3,5x35	98	OG28--M	OKVIR EDGE 4x2M	123
CM19	SET VIJAKOV 3,5x50	98	OG13--M	OKVIR EDGE 1/3M	124
CM22--	SET ZA STIKALA Z NAPISNO PLOŠČICO IP44 2M	98	OG30--M	OKVIR EDGE 3M	124
CM23--	SET ZA VTIČNICE Z NAPISNO PLOŠČICO IP44 2M	98	OG40--M	OKVIR EDGE 4M	124
CM25--OL	KOPALNIŠKI SET 3x20A 250V- 4M OL	98	OG70--M	OKVIR EDGE 7M	124
CM25--OS	KOPALNIŠKI SET 3x20A 250V- 4M OS	98	OG23--M	OKVIR EDGE 2/3M	124
CM28--	SET ZA STIKALA IP44 2M	99	<b>NOSILCI NM</b>		
CM29--	SET ZA VTIČNICE IP44 2M	99	NM10	NOSILEC S KREMPELJCI 1/2M	130
NM41	NOSILEC KOPALNIŠKI SET 4M	99	NM11	NOSILEC BREZ VIJAKOV 1/2M	130
OL41--	OKVIR LINE KOPALNIŠKI SET	99	NM20	NOSILEC S KREMPELJCI 2M	130
OS41--	OKVIR SOFT KOPALNIŠKI SET	99	NM21	NOSILEC BREZ VIJAKOV 2M	130
<b>ANTIBAKTERIJSKI PROGRAM AW</b>			NM24	NOSILEC KOVINSKI S KREMPELJCI 2M	131
TM11AW	TIPKA 1M	101	NM25	NOSILEC KOVINSKI BREZ VIJAKOV 2M	131
TM11AWIN	TIPKA 1M IN	101	NM26	NOSILEC OJAČEN S KREMPELJCI 2M	131
TM12AW	TIPKA 2M	101	NM27	NOSILEC OJAČEN BREZ VIJAKOV 2M	131
TM12AWIN	TIPKA 2M IN	101	NM23	NOSILEC S KREMPELJCI 2/3M	131
TM21AW	POLNILO 1M	101	NM30	NOSILEC Z VIJAKI 3M	132
TM22AW	POLNILO 2M	101	NM40	NOSILEC Z VIJAKI 4M	132
VM10AW	VTIČNICA SCHUKO+KS 2P+E 16A 250V- 2M	102	NM70	NOSILEC Z VIJAKI 7M	132
VM11AW	VTIČNICA SCHUKO+KS+POKROV 2P+E 16A 250V- 2M	102	NM75	NOSILEC OJAČEN Z VIJAKI 7M	132
VM20AW	VTIČNICA EURO+KS 2P 10A 250V- 1M	102	NM72	NOSILEC Z VIJAKI 2x7M	132
KM11AW	VTIČNICA TV KONČNA 1dB 1M	102	NM32	NOSILEC Z VIJAKI 2/3M	133
KM35AW	ADAPTER KS 1M	102			
OS20AW	OKVIR SOFT 2M	103			
OS24AW	OKVIR SOFT 2x2M	103			
OS26AW	OKVIR SOFT 3x2M	103			
OS30AW	OKVIR SOFT 3M	103			
OS40AW	OKVIR SOFT 4M	103			
OS70AW	OKVIR SOFT 7M	103			

## D O Z E

šifra	opis izdelka	stran
<b>OKROGLE DOZE</b>		
DE10	DOZA OKROGLA ZA ZID SM60-01	136
DE11	DOZA OKROGLA ZA ZID GLOBOKA SM60-06	136
DE30	VEZNI ČLEN DOZE ZA ZID SM60-03	136
DE31	VEZNI ČLEN DOZE ZA ZID SM60-04	136
DE12	DOZA OKROGLA ZA ZID 65-46	137
DE13	DOZA OKROGLA ZA ZID 65-60	137
DE14	PODALJŠEK DOZE ZA ZID 65-46	137
DE32	VEZNI ČLEN DOZE ZA ZID 65-71	137
DE33	VEZNI ČLEN DOZE ZA ZID 65-91	137
DE20	POKROV DOZE ZAŠČITNI 60	137
DE21	POKROV DOZE ZAŠČITNI 65	137
DE22	POKROV DOZE DEKORATIVNI SM60	137
HE10	DOZA OKROGLA ZA VOTLE STENE SM68x40	140
HE11	DOZA OKROGLA ZA VOTLE STENE SM68x55	140
BE10	DOZA OKROGLA ZA BETON 60-49	140
BE11	DOZA OKROGLA ZA BETON 60-77	140
BE20	NOSILEC DOZE ZA BETON	140
BE21	UVODNICA DOZE ZA BETON 16	140
<b>PRAVOKOTNE DOZE</b>		
DM30	DOZA PRAVOKOTNA ZA ZID PM3	144
DM31	DOZA PRAVOKOTNA ZA ZID PM3-65	144
DM40	DOZA PRAVOKOTNA ZA ZID PM4	144
DM41	DOZA PRAVOKOTNA ZA ZID PM4-65	144
DM70	DOZA PRAVOKOTNA ZA ZID PM7	145
DM71	DOZA PRAVOKOTNA ZA ZID PM7-65	145
DM72	DOZA PRAVOKOTNA ZA ZID PM72-65	145
DM80	VEZNI ČLEN DOZE PM	145
DM33	POKROV DOZE ZAŠČITNI PM3	146
DM34	POKROV DOZE DEKORATIVNI PM3	146
DM43	POKROV DOZE ZAŠČITNI PM4	146
DM44	POKROV DOZE DEKORATIVNI PM4	146
DM73	POKROV DOZE ZAŠČITNI PM7	146
DM74	POKROV DOZE DEKORATIVNI PM7	146
DM75	POKROV DOZE DEKORATIVNI PM72	147
HM30	DOZA PRAVOKOTNA ZA VOTLE STENE VM3	148
HM40	DOZA PRAVOKOTNA ZA VOTLE STENE VM4	148
HM70	DOZA PRAVOKOTNA ZA VOTLE STENE VM7	148
HM72	DOZA PRAVOKOTNA ZA VOTLE STENE VM72	148
BM30	DOZA PRAVOKOTNA ZA BETON BM3	149
BM40	DOZA PRAVOKOTNA ZA BETON BM4	149
BM70	DOZA PRAVOKOTNA ZA BETON BM7	149
BM80	PRITRDLJNI ČLEN DOZ BM	149
BM82	DISTANČNI PROFIL ZA DOZE	149
<b>RAZVODNE DOZE</b>		
DW10	RAZVODNA DOZA OKROGLA ZA ZID DSM78	152
HW10	RAZVODNA DOZA OKROGLA ZA VOTLE STENE SM78x45	152
DE23	POKROV DOZE DEKORATIVNI SM78	152
DE24	POKROV DOZE ZAŠČITNI 78	152
HW20	RAZVODNA DOZA KVADRATNA ZA VOTLE STENE SM105x105	152
<b>PRIBOR ZA OŽIČENJE</b>		
UW10--	ENOREDNE SPONKE ZAPRTE PC 2x2.5mm <sup>2</sup> 10P	154
UW11--	ENOREDNE SPONKE ZAPRTE PC 2x4mm <sup>2</sup> 10P	154
UW12--	ENOREDNE SPONKE ZAPRTE PC 2x6mm <sup>2</sup> 10P	154
UW15--	ENOREDNE SPONKE PA 2x2.5mm <sup>2</sup> 12P	154
UW16--	ENOREDNE SPONKE PA 2x4mm <sup>2</sup> 12P	154
UW17--	ENOREDNE SPONKE PA 2x6mm <sup>2</sup> 12P	154
UW29--	DVOREDNE SPONKE PP 1.0-4.0mm <sup>2</sup> 12P	154
UW30--	DVOREDNE SPONKE PP 1.5-6.0mm <sup>2</sup> 12P	154
UW31--	DVOREDNE SPONKE PP 2.5-10mm <sup>2</sup> 12P	154
UW32--	DVOREDNE SPONKE PP 4.0-16mm <sup>2</sup> 12P	154
UW27--	DVOREDNE SPONKE PA 2.5-10mm <sup>2</sup> 12P	155
UW28--	DVOREDNE SPONKE PA 4.0-16mm <sup>2</sup> 12P	155
UW40--	BREZVIJAČNE SPONKE PA 1.5mm <sup>2</sup> 3P	155
UW41--	BREZVIJAČNE SPONKE PA 1.5mm <sup>2</sup> 5P	155
UW42--	BREZVIJAČNE SPONKE PA 1.5mm <sup>2</sup> 8P	155
UW45--	BREZVIJAČNE SPONKE PA 2.5mm <sup>2</sup> 3P	155
UW46--	BREZVIJAČNE SPONKE PA 2.5mm <sup>2</sup> 4P	155
UW47--	BREZVIJAČNE SPONKE PA 2.5mm <sup>2</sup> 5P	155
UW50--	BREZVIJAČNE SPONKE PA 2.5mm <sup>2</sup> 2/1P	155

## distribucija

šifra	opis izdelka	stran
<b>OHIŠJA CUBO IP20 AC</b>		
AC11--	OHIŠJE NO CUBO Z DNOM IP20 1M	158
AC21--	OHIŠJE NO CUBO Z DNOM IP20 2M	158
AC41--	OHIŠJE NO CUBO Z DNOM IP20 4M	158
AC61--	OHIŠJE NO CUBO Z DNOM IP20 6M	158
<b>OHIŠJA CUBO IP55 AQ</b>		
AQ20--	OHIŠJE NO CUBO IP55 2M	159
AQ22--	OHIŠJE NO CUBO IP55 2x2M	159
AQ30--	OHIŠJE NO CUBO IP55 3M	159
AQ21--	OHIŠJE PO CUBO IP55 2M	160
AQ31--	OHIŠJE PO CUBO IP55 3M	160
<b>PARAPETNI KANALI ALUMINIJSKI MA</b>		
RT10	ADAPTER MA 92	161
RT12--	OKVIR MA 92 2/3M	161
RT14--	OKVIR MA 92 4M	161
RT17--	OKVIR MA 92 7M	161
RT20--	OSNOVA KANALA MA 130x65	162
RT21--	OSNOVA KANALA MA 165x65	162
RT25--	POKROV KANALA MA 92	162
RT30	PREGRADA MA 43	162
RT31	PREGRADA MA 43 AL	162
RT32	PREGRADA MA 43 AL DVOJNA	162
RT35--	KONČNI ELEMENT MA 130x65	163
RT36--	KONČNI ELEMENT MA 165x65	163
RT38	SET RAVNI VEZNI ELEMENT MA 65	163
RT40--	UNIVERZALNI KOT MA 130x65	163
RT41--	UNIVERZALNI KOT MA 165x65	163
RT42	OZEMLJITVENA SPONKA MA 2x A6.3	163
RT43--	L KOTNI ELEMENT MA 130x65 / 130	163
RT44--	L KOTNI ELEMENT MA 165x65 / 130	164
RT47--	L KOTNI ELEMENT MA 165x65 / 165	164
RT45--	T ELEMENT MA 130x65 / 130	164
RT46--	T ELEMENT MA 165x65 / 130	164
RT48--	T ELEMENT MA 165x65 / 165	164
RT50--	NOSILEC STEBRIČKA MA ENOJNI 130x65 / 130	165
RT51--	NOSILEC STEBRIČKA MA DVOJNI 130x65	165
RT52--	STEBRIČEK MA 130x65x500	165
RT53--	STEBRIČEK MA DVOJNI 130x65x500	165
<b>TALNE DOZE MT</b>		
RB50	VGRADNO OHIŠJE TALNE DOZE 4M	167
RB60	VLOŽEK TALNE DOZE 4M	167
RB65S1	POKROV TALNE DOZE 4M	167
RB51	VGRADNO OHIŠJE TALNE DOZE 7M	167
RB61	VLOŽEK TALNE DOZE 7M	167
RB66S1	POKROV TALNE DOZE 7M	167
RB52	VGRADNO OHIŠJE TALNE DOZE 2X7M	168
RB62	VLOŽEK TALNE DOZE 2X7M	168
RB67S2	POKROV TALNE DOZE 2X7M	168
RB53	VGRADNO OHIŠJE TALNE DOZE 4X7M	168
RB62	VLOŽEK TALNE DOZE 2X7M	168
RB68S2	POKROV TALNE DOZE 4X7M	168
RB55S1	TALNA DOZA ZA DVOJNA TLA S POKROVOM 4M	169
RB60	VLOŽEK TALNE DOZE 4M	169
RB56S1	TALNA DOZA ZA DVOJNA TLA S POKROVOM 7M	170
RB61	VLOŽEK TALNE DOZE 7M	170
RB57S2	TALNA DOZA ZA DVOJNA TLA S POKROVOM 2X7M	170
RB62	VLOŽEK TALNE DOZE 2X7M	170
RB58S2	TALNA DOZA ZA DVOJNA TLA S POKROVOM 4X7M	170
RB62	VLOŽEK TALNE DOZE 2X7M	170
RB10	ADAPTER ZA DIN LETEV 35mm 1M	171
RB11	ADAPTER ZA DIN LETEV 35mm 2M	171

šifra	opis izdelka	stran	šifra	opis izdelka	stran
<b>STIKALA SQ</b>			<b>PRIBOR PQ</b>		
SQ10--XO	STIKALO ENOPOLNO 10AX 250V-	192	PQ10--XO	POLNILO	213
SQ10--INXO	STIKALO ENOPOLNO 10AX 250V- __ IN	192	PQ30--	POKROV TAE/TDO	213
SQ11--XO	TIPKALO ENOPOLNO 10A 250V-	192	PQ20PWF	OHIŠJE NADOMETNO 1	214
SQ11--IN01XO	TIPKALO ENOPOLNO 10A 250V- __ IN 01	192	PQ21PWF	OHIŠJE NADOMETNO ZA DVOJNO VTIČNICO	214
SQ11--IN02XO	TIPKALO ENOPOLNO 10A 250V- __ IN 02	193	PQ22--F	SET ZA STIKALA FLAT IP44	215
SQ11--ILXO	TIPKALO ENOPOLNO 10A 250V- __ IL	193	PQ23--F	SET ZA VTIČNICE FLAT IP44	215
SQ22--IN03XO	STIKALO DVOPOLNO 16AX 250V- __ IN 03	193	<b>OKVIRJI OF</b>		
SQ50--XO	STIKALO SERIJSKO 10AX 250V-	193	OF10--	OKVIR FLAT 1	216
SQ51--XO	TIPKALO SERIJSKO 10A 250V-	193	OF20--	OKVIR FLAT 2	216
SQ52--NT09XO	STIKALO ŽALUZIJSKO 10AX 250V- __ NT 09	193	OF30--	OKVIR FLAT 3	217
SQ53--NT09XO	TIPKALO ŽALUZIJSKO 10A 250V- __ NT 09	194	OF40--	OKVIR FLAT 4	217
SQ60--XO	STIKALO MENJALNO 10AX 250V-	194	OF50--	OKVIR FLAT 5	217
SQ60--INXO	STIKALO MENJALNO 10AX 250V- __ IN	194	<b>OKVIRJI OQ</b>		
SQ60--IN02XO	STIKALO MENJALNO 10AX 250V- __ IN02	194	OQ10--	OKVIR BOLD 1	218
SQ63--XO	STIKALO DVOJNO MENJALNO 10AX 250V-	195	OQ20--	OKVIR BOLD 2	218
SQ70--XO	STIKALO KRIŽNO 10AX 250V-	195	OQ30--	OKVIR BOLD 3	219
<b>SIGNALIZACIJA IA</b>			OQ40--	OKVIR BOLD 4	219
IA10--	TLIVKA 230V- 0,34W	196	OQ50--	OKVIR BOLD 5	219
IA20--	LED SIGNALIZACIJA 230V- AC/DC 0,4W	196	<b>OKVIRJI OR</b>		
IA21--	LED SIGNALIZACIJA 24V AC/DC 0,2W	196	OR10--	OKVIR PRIME 1	220
IA22--	LED SIGNALIZACIJA 12V AC/DC 0,1W	196	OR20--	OKVIR PRIME 2	220
<b>VTIČNICE VQ</b>			OR30--	OKVIR PRIME 3	221
VQ10--XO	VTIČNICA SCHUKO 2P+E 16A 250V- __ XO	199	OR40--	OKVIR PRIME 4	221
VQ11--XO	VTIČNICA SCHUKO+POKROV 2P+E 16A 250V- __ XO	199			
VQ12--XO	VTIČNICA SCHUKO 2P+E 16A 250V- BV __ XO	199			
VQ13--XO	VTIČNICA SCHUKO+POKROV 2P+E 16A 250V- BV __ XO	199			
VQ40--XO	VTIČNICA FRANCOSKA 2P+E 16A 250V- __ XO	200			
VQ41--XO	VTIČNICA FRANCOSKA+POKROV 2P+E 16A 250V- __ XO	200			
VQ16--	VTIČNICA SCHUKO DVOJNA 2P+E 16A 250V-	200			
VQ16--F	VTIČNICA SCHUKO DVOJNA 2P+E 16A 250V-	200			
VQ42--XO	VTIČNICA FRANCOSKA 2P+E 16A 250V- BV __ XO	201			
VQ43--XO	VTIČNICA FRANCOSKA+POKROV 2P+E 16A 250V- BV __ XO	201			
VQ46--	VTIČNICA FRANCOSKA DVOJNA 2P+E 16A 250V-	201			
VQ46--F	VTIČNICA FRANCOSKA DVOJNA 2P+E 16A 250V-	201			
<b>KOMUNIKACIJE KQ</b>					
KQ10--XO	VTIČNICA TV OSNOVNA 0dB	202			
KQ11--XO	VTIČNICA TV-R KONČNA 1dB	202			
KQ12--XO	VTIČNICA TV-R PREHODNA 10dB	203			
KQ16--XO	VTIČNICA SAT-TV-R KONČNA 3dB	203			
KQ22--XO	VTIČNICA AVDIO 2xRCA	203			
KQ23--XO	VTIČNICA AVDIO ZVOČNIŠKA	204			
KQ36--XO	VTIČNICA TEL KS RJ11 6/4	204			
KQ37--XO	VTIČNICA CAT5e KS RJ45 8/8	204			
KQ38--XO	VTIČNICA TEL KS DVOJNA 2x RJ11 6/4	204			
KQ39--XO	VTIČNICA CAT5e KS DVOJNA 2x RJ45 8/8	205			
KQ35--XO	VTIČNICA TEL LT RJ11 6/4	205			
KQ40--XO	VTIČNICA CAT6s KS RJ45 8/8 SLIM	205			
KQ41--XO	VTIČNICA CAT6s KS DVOJNA 2x RJ45 8/8 SLIM	205			
<b>ELEKTRONIKA EQ</b>					
EQ15--XO	ZATEMNILNIK ROTACIJSKI MEN RL 400W	206			
EQ16--XO	ZATEMNILNIK ROTACIJSKI MEN RLC 400W	206			
EQ19--XO	ZATEMNILNIK ROTACIJSKI MEN LED 100W	206			
EM17	KRMILNI MODUL MZC za EM18	208			
EM18	ZATEMNILNIK VGRADNI LED 250W	208			
EM19	ZATEMNILNIK VGRADNI DC LED 96W	209			
EQ32--XO	IR STIKALO 5A 230V-	210			
EQ35--XO	TERMOSTAT OGREVANJE 10A 230V-	210			
EQ36--XO	TERMOSTAT OGREVANJE / HLAJENJE 5A 230V-	210			
EQ37--XO	TERMOSTAT TALNO OGREVANJE 16A 230V-	211			
EQ01--XO	PODOMETNI RADIO + ZVOČNIK DAB BLUETOOTH	211			
EQ02--XO	PODOMETNI ZVOČNIK	211			
EQ69--XO	POLNILNIK USB PD 20W	212			

šifra	opis izdelka	stran
<b>STIKALA SE</b>		
SE10	STIKALO ENOPOLNO 10AX 250V-	232
SE11	TIPKALO ENOPOLNO 10A 250V-	232
SE22	STIKALO DVOPOLNO 16AX 250V-	232
SE50	STIKALO SERIJSKO 10AX 250V-	232
SE51	TIPKALO SERIJSKO 10A 250V-	233
SE52	STIKALO ŽALUZIJSKO 10AX 250V-	233
SE53	TIPKALO ŽALUZIJSKO 10A 250V-	233
SE60	STIKALO MENJALNO 10AX 250V-	233
SE63	STIKALO DVOJNO MENJALNO 10AX 250V-	233
SE70	STIKALO KRIŽNO 10AX 250V-	233
SE10--	STIKALO ENOPOLNO 10AX 250V-	234
SE10--IN	STIKALO ENOPOLNO 10AX 250V- IN	234
SE11--	TIPKALO ENOPOLNO 10A 250V-	234
SE11--TI50	TIPKALO ENOPOLNO 10A 250V- TI 50	234
SE11--TI51	TIPKALO ENOPOLNO 10A 250V- TI 51	234
SE11--IL	TIPKALO ENOPOLNO 10A 250V- IL	234
SE22--IN03	STIKALO DVOPOLNO 16AX 250V- IN 03	234
SE50--	STIKALO SERIJSKO 10AX 250V-	235
SE51--	TIPKALO SERIJSKO 10A 250V-	235
SE52--NT09	STIKALO ŽALUZIJSKO 10AX 250V- NT 09	235
SE53--NT09	TIPKALO ŽALUZIJSKO 10A 250V- NT 09	235
SE60--	STIKALO MENJALNO 10AX 250V-	235
SE63--	STIKALO DVOJNO MENJALNO 10AX 250V-	235
SE70--	STIKALO KRIŽNO 10AX 250V-	235
<b>TIPKE TE</b>		
TE10--	TIPKA NAVADNA	236
TE10--IN	TIPKA INDIKATOR	236
TE13--IL	TIPKA Z NAPISNO PLOŠČICO IL	236
TE11--	TIPKA SERIJSKA	236
<b>SIGNALIZACIJA IA</b>		
IA10--	TLIVKA 230V- 0,34W	237
IA20--	LED SIGNALIZACIJA 230V- AC/DC 0,4W	237
IA21--	LED SIGNALIZACIJA 24V AC/DC 0,2W	237
IA22--	LED SIGNALIZACIJA 12V AC/DC 0,1W	237
<b>VTIČNICE VE</b>		
VE10--XO	VTIČNICA SCHUKO 2P+E 16A 250V- XO	240
VE11--XO	VTIČNICA SCHUKO+POKROV 2P+E 16A 250V- XO	240
VE12--XO	VTIČNICA SCHUKO 2P+E 16A 250V- BV XO	240
VE13--XO	VTIČNICA SCHUKO+POKROV 2P+E 16A 250V- BV XO	240
VE10--	VTIČNICA SCHUKO 2P+E 16A 250V-	240
VE11--	VTIČNICA SCHUKO+POKROV 2P+E 16A 250V-	240
VE12--	VTIČNICA SCHUKO 2P+E 16A 250V- BV	240
VE13--	VTIČNICA SCHUKO+POKROV 2P+E 16A 250V- BV	240
VE40--XO	VTIČNICA FRANCOSKA 2P+E 16A 250V- XO	241
VE41--XO	VTIČNICA FRANCOSKA+POKROV 2P+E 16A 250V- XO	241
VE42--XO	VTIČNICA FRANCOSKA 2P+E 16A 250V- BV XO	241
VE43--XO	VTIČNICA FRANCOSKA+POKROV 2P+E 16A 250V- BV XO	241
VE40--	VTIČNICA FRANCOSKA 2P+E 16A 250V-	241
VE41--	VTIČNICA FRANCOSKA+POKROV 2P+E 16A 250V-	241
VE42--	VTIČNICA FRANCOSKA 2P+E 16A 250V- BV	241
VE43--	VTIČNICA FRANCOSKA+KS+POKROV 2P+E 16A 250V- BV	241
VE16--	VTIČNICA SCHUKO DVOJNA 2P+E 16A 250V-	242
VE46--	VTIČNICA FRANCOSKA DVOJNA 2P+E 16A 250V-	242
VE30--	VTIČNICA 2P 16A 250V-	242
<b>KOMUNIKACIJE KE</b>		
KE11	VTIČNICA TV-R KONČNA 1dB	243
KE12	VTIČNICA TV-R PREHODNA 10dB	243
KE16	VTIČNICA SAT-TV-R KONČNA 3dB	243
KE36	VTIČNICA TEL KS RJ11 6/4	243
KE37	VTIČNICA CAT5e KS RJ45 8/8	244
KE40	VTIČNICA CAT6s KS RJ45 8/8 SLIM	244
KE38	VTIČNICA TEL KS DVOJNA 2x RJ11 6/4	244
KE39	VTIČNICA CAT5e KS DVOJNA 2x RJ45 8/8	244
KE41	VTIČNICA CAT6s KS DVOJNA 2x RJ45 8/8 SLIM	244
KE45	ADAPTER KS ENOJNI	244
KE46	ADAPTER KS DVOJNI	245
KE47	ADAPTER PD DVOJNI	245
KE10--	VTIČNICA TV OSNOVNA 0dB	246
KE11--	VTIČNICA TV-R KONČNA 1dB	246
KE12--	VTIČNICA TV-R PREHODNA 10dB	246
KE16--	VTIČNICA SAT-TV-R KONČNA 3dB	246
KE22--	VTIČNICA AVDIO 2xRCA	246
KE23--	VTIČNICA AVDIO ZVOČNIŠKA	246
KE36--	VTIČNICA TEL KS RJ11 6/4	246
KE37--	VTIČNICA CAT5e KS RJ45 8/8	247
KE40--	VTIČNICA CAT6s KS RJ45 8/8 SLIM	247
KE38--	VTIČNICA TEL KS DVOJNA 2x RJ11 6/4	247
KE39--	VTIČNICA CAT5e KS DVOJNA 2x RJ45 8/8	247
KE41--	VTIČNICA CAT6s KS DVOJNA 2x RJ45 8/8 SLIM	247
KE35--	VTIČNICA TEL LT RJ11 6/4	247

šifra	opis izdelka	stran
<b>POKROVI PE</b>		
PE10--	POKROV TV-R 2P/3P	248
PE20--	POKROV KS ENOJNI	248
PE21--	POKROV KS DVOJNI	248
PE30--	POKROV TAE/TDO	248
<b>ELEKTRONIKA EE</b>		
EE15	ZATEMNILNIK ROTACIJSKI MEN RL 400W	249
EE16	ZATEMNILNIK ROTACIJSKI MEN RLC 400W	249
EE19	ZATEMNILNIK ROTACIJSKI MEN LED 100W	250
EE32	IR STIKALO 5A 230V-	250
EE15--	ZATEMNILNIK ROTACIJSKI MEN RL 400W	251
EE16--	ZATEMNILNIK ROTACIJSKI MEN RLC 400W	251
EE19--	ZATEMNILNIK ROTACIJSKI MEN LED 100W	251
EE32--	IR STIKALO 5A 230V-	251
EE69--	POLNILNIK USB PD 20W	252
<b>POKROVI ELEKTRONIKE PE</b>		
PE41--	POKROV ZATEMNILNO STIKALO Ø6	254
PE32--	POKROV IR STIKALO	254
<b>PRIBOR AE</b>		
AE10--	POLNILO	255
AE20--	PRIKLJUČEK PETPOLNI STALNI 3P+N+E 5x4mm <sup>2</sup>	255
AE30--	OHIŠJE NADOMETNO 1	255
AE31--	OHIŠJE NADOMETNO ZA DVOJNO VTIČNICO EKONOMIK	255
AE50--	STENSKI ŠČITNIK	256
AE51--	OTROŠKA ZAŠČITA KS	256
<b>OKVIRJI OE</b>		
OE10--	OKVIR EKONOMIK 1	257
OE20--	OKVIR EKONOMIK 2 HORIZONTALNI	257
OE21--	OKVIR EKONOMIK 2 VERTIKALNI	257
OE30--	OKVIR EKONOMIK 3 HORIZONTALNI	257
OE31--	OKVIR EKONOMIK 3 VERTIKALNI	258
OE40--	OKVIR EKONOMIK 4 HORIZONTALNI	258
OE41--	OKVIR EKONOMIK 4 VERTIKALNI	258
OE50--	OKVIR EKONOMIK 5 HORIZONTALNI	258
OE90--	DEKORATIVNI OKVIRČKI COLOR	259

**fontana**

šifra	opis izdelka	stran
<b>STIKALA SF</b>		
SF10--	STIKALO ENOPOLNO IP44 10AX 250V-	262
SF10--TI	STIKALO ENOPOLNO IP44 10AX 250V- TI	262
SF11--TI	TIPKALO ENOPOLNO IP44 10A 250V- TI	262
SF20--	STIKALO DVOPOLNO IP44 10AX 250V-	262
SF50--	STIKALO SERIJSKO IP44 10AX 250V-	263
SF51--	TIPKALO SERIJSKO IP44 10A 250V-	263
SF60--	STIKALO MENJALNO IP44 10AX 250V-	263
SF60--TI	STIKALO MENJALNO IP44 10AX 250V- TI	263
SF63--	STIKALO DVOJNO MENJALNO 10AX 250V-	263
SF70--	STIKALO KRIŽNO IP44 10AX 250V-	263
<b>VTIČNICE VF</b>		
VF10--	VTIČNICA SCHUKO+POKROV IP44 2P+E 16A 250V-	264
VF12--	VTIČNICA SCHUKO+POKROV IP44 2P+E 16A 250V- BV	264
<b>SETI CF</b>		
CF10--	SET VTIČNICA SCHUKO DVOJNI HORIZONTALNI IP44 2x2P+E 16A 250V-	265
CF11--	SET VTIČNICA SCHUKO DVOJNI VERTIKALNI IP44 2x2P+E 16A 250V-	265
CF12--	SET VTIČNICA SCH + STIKALO MEN HORIZONTALNI IP44 16A + 10AX 250V-	265
CF13--	SET VTIČNICA SCH + STIKALO MEN VERTIKALNI IP44 16A + 10AX 250V-	266
CF14--	SET VTIČNICA SCHUKO DVOJNI HORIZONTALNI IP44 2x 2P+E 16A 250V-BV	266
CF15--	SET VTIČNICA SCHUKO DVOJNI VERTIKALNI IP44 2x 2P+E 16A 250V- BV	266
CF16--	SET VTIČNICA SCH + STIKALO MEN HORIZONTALNI IP44 16A + 10AX 250V- BV	266
CF17--	SET VTIČNICA SCH+STIKALO MEN VERTIKALNI IP44 16A + 10AX 250V- BV	266
<b>PRIBOR AF</b>		
AF10--	RAZVODNICA IP44 RN01	267
AF20--	RAZVODNICA IP55 ND01	267







**TEM**  
On | Off and everything in between

ekonomik  
MODUL  
LOGIQ

100% ELEKTRIČEN

www.tem.si



**TEM**  
On | Off and everything in between



TEM

M  
n between



www.tem.si

**TEM**

TEM ČATEŽ d.o.o.  
Čatež 13, 8212 VELIKA LOKA  
SLOVENIJA  
tem@tem.si  
www.tem.si

T +386(0)7 348 99 00

